

NYDOVIST & HOLM  
TROLLHÄTTAN.

FÖR LINDEN och LOCKET

A	67	103	154
B	41	77	125
D	46	82	128
E	30	66	93
F	2260	2250	1900
G	125	125	154
H	288	288	371
K	211	211	239
L	107	107	180
M	52	52	107

FÖR KANNAN

185% SLAG	220% SLAG	300% SLAG	
N	144	144	194
P	106	106	180
Q	90	90	145

DET. NO	MÖD. NO	ST.	MATERIAL	BENÄMNING	ANM.
30108	1	23294	I	GJÄRN	CYLINDER
30109	2	23295	I	"	LOCK
30110	3	23296	I	"	KANNA
	4	23297	I	"	GLÄNDER
	5		I	KAUTSCHUK	PACKNING
	6	22867	I	METALL	RING
	7	22868	I	"	FODER
	8		5	SMJÄRNET	$\frac{3}{8}$ SKRUF-PINN
	9		6	"	$\frac{1}{2}$ " SKALL
	10		6	"	$\frac{1}{2}$ MUTTER
	11		6	"	$\frac{3}{4}$ " SAXPINNE
	12		I	"	FLÄNS
	13		5	"	$\frac{3}{8}$ MUTTER
	14		I	GUMMI	PACKNING
	15				

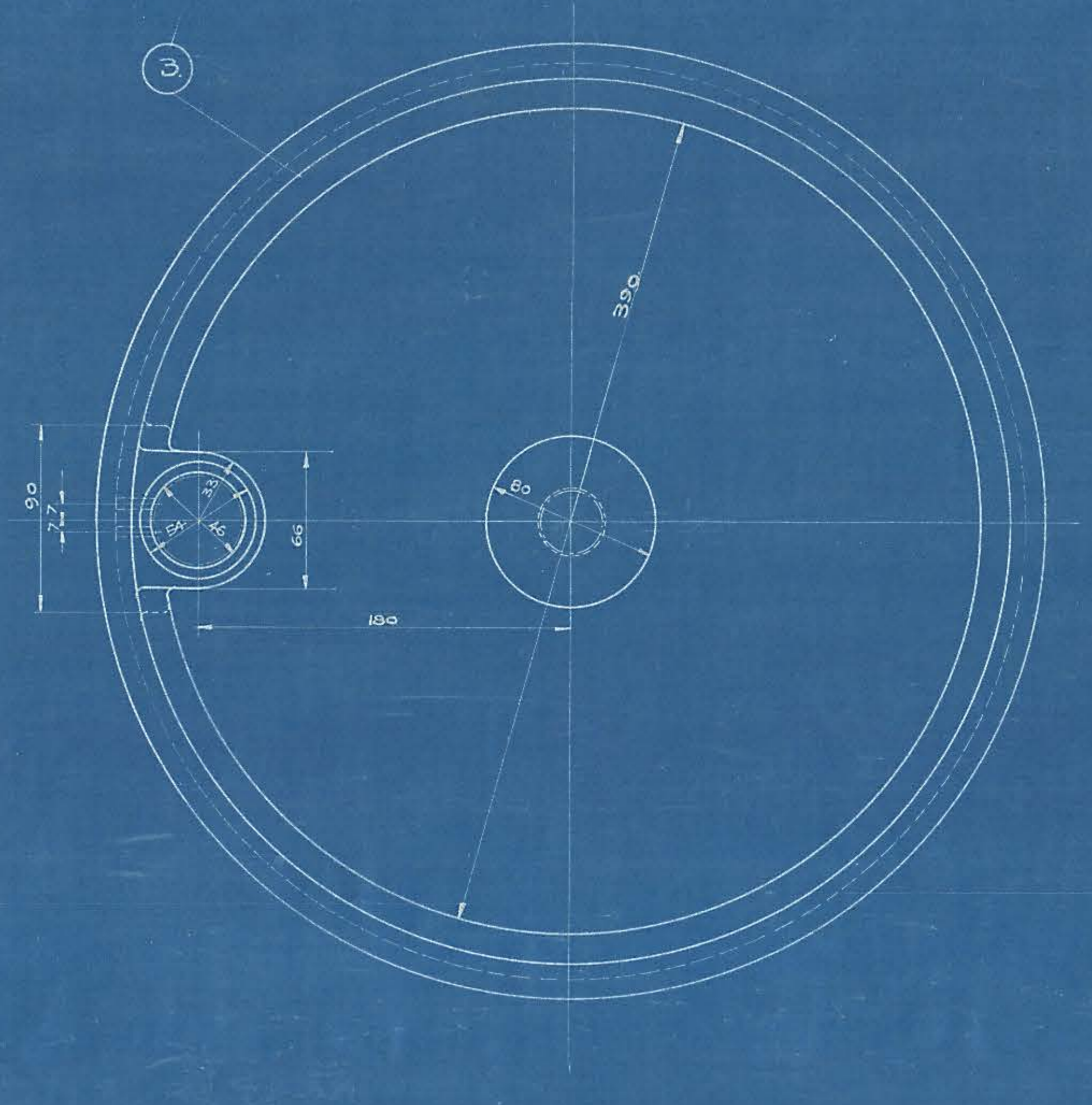
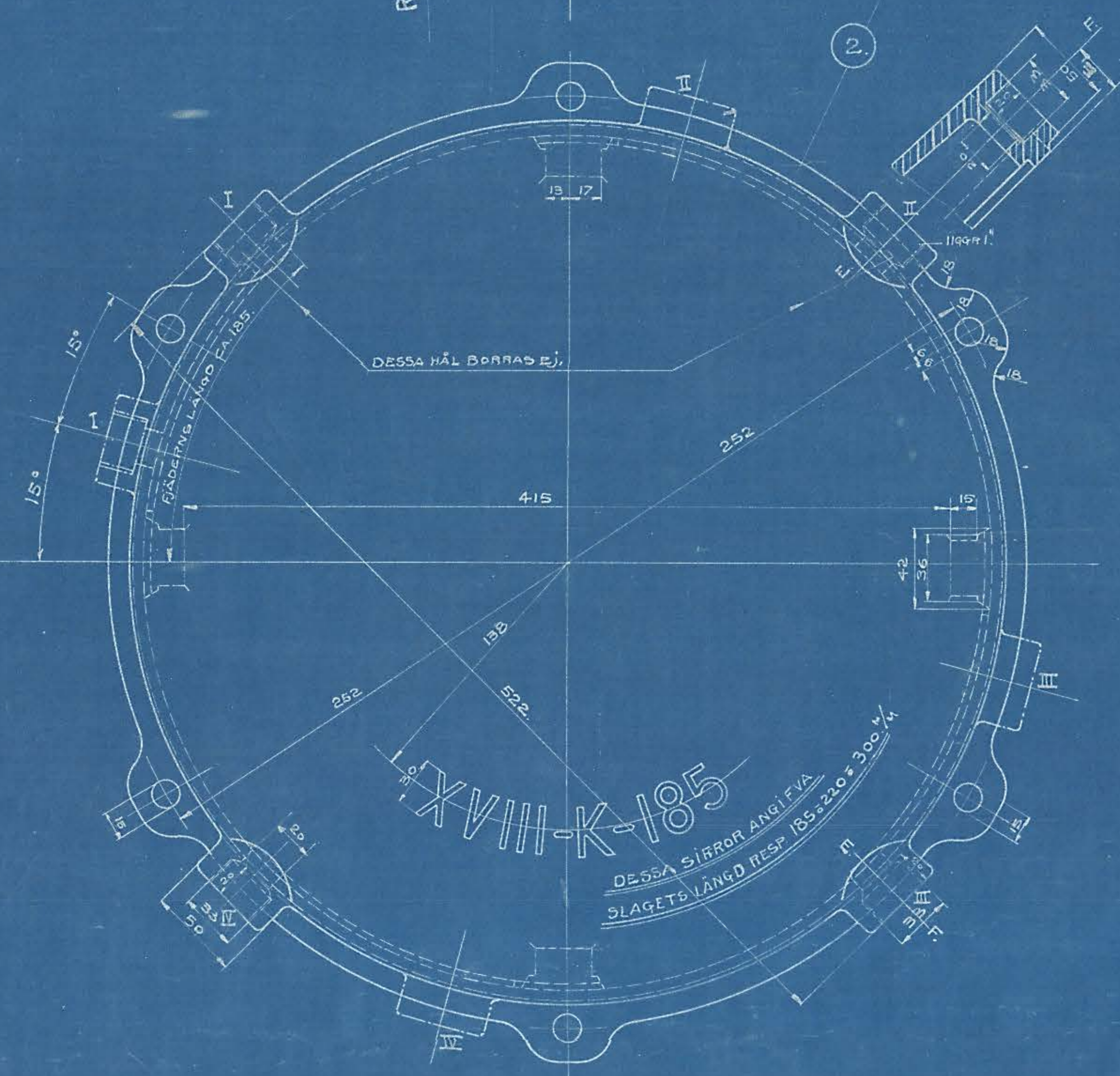
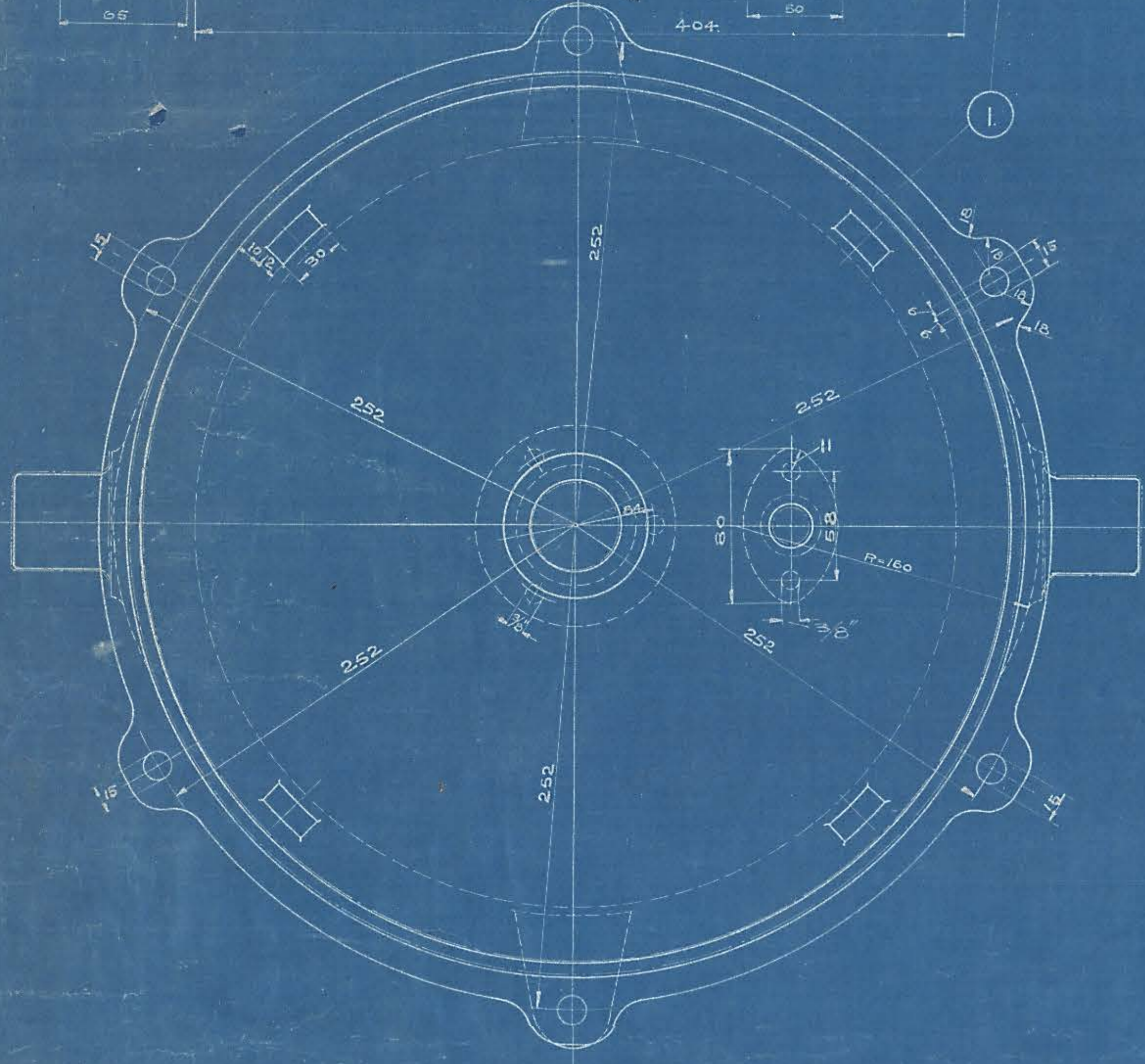
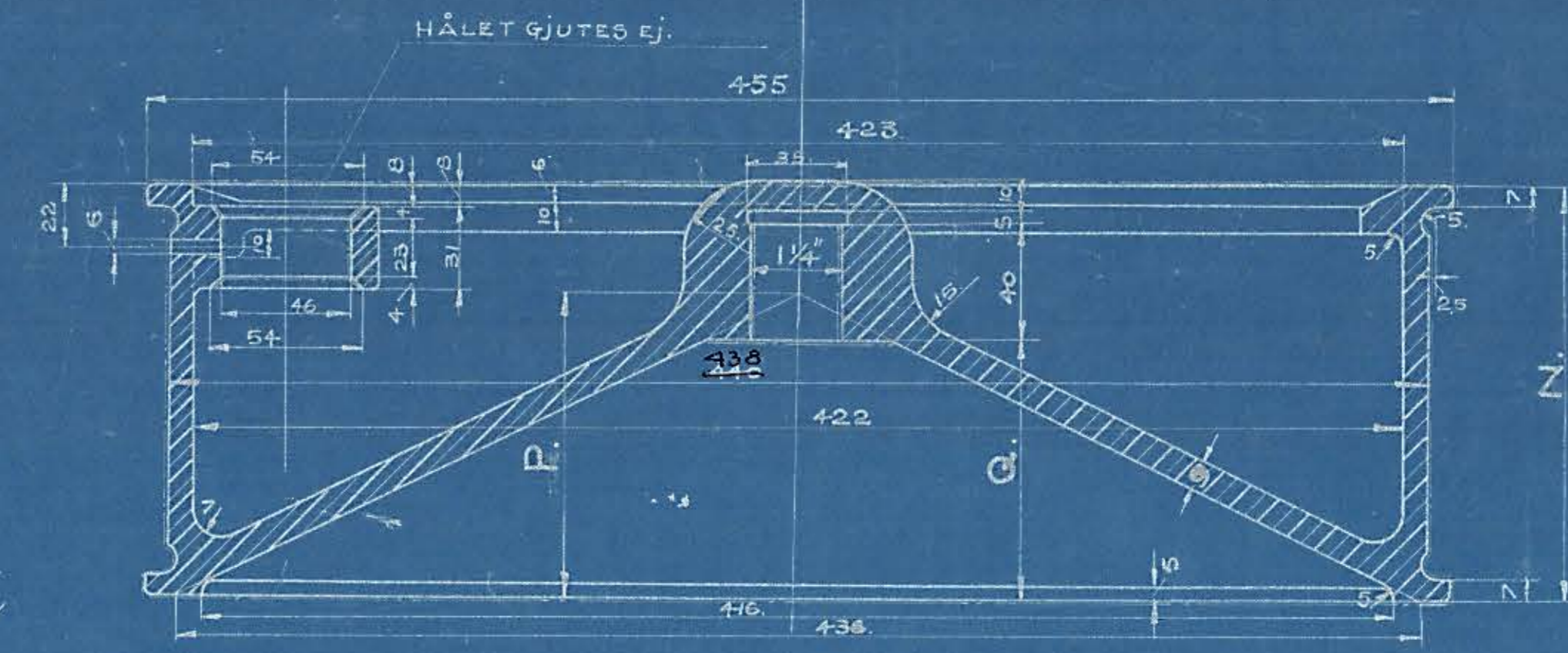
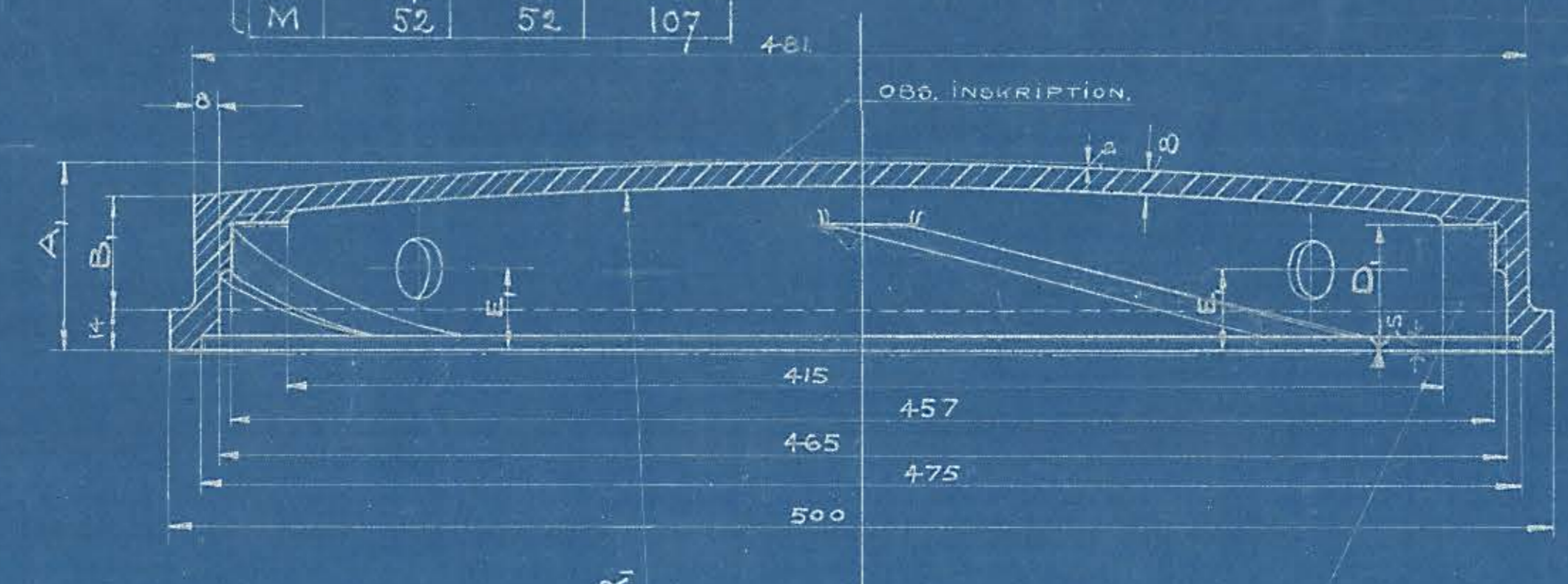
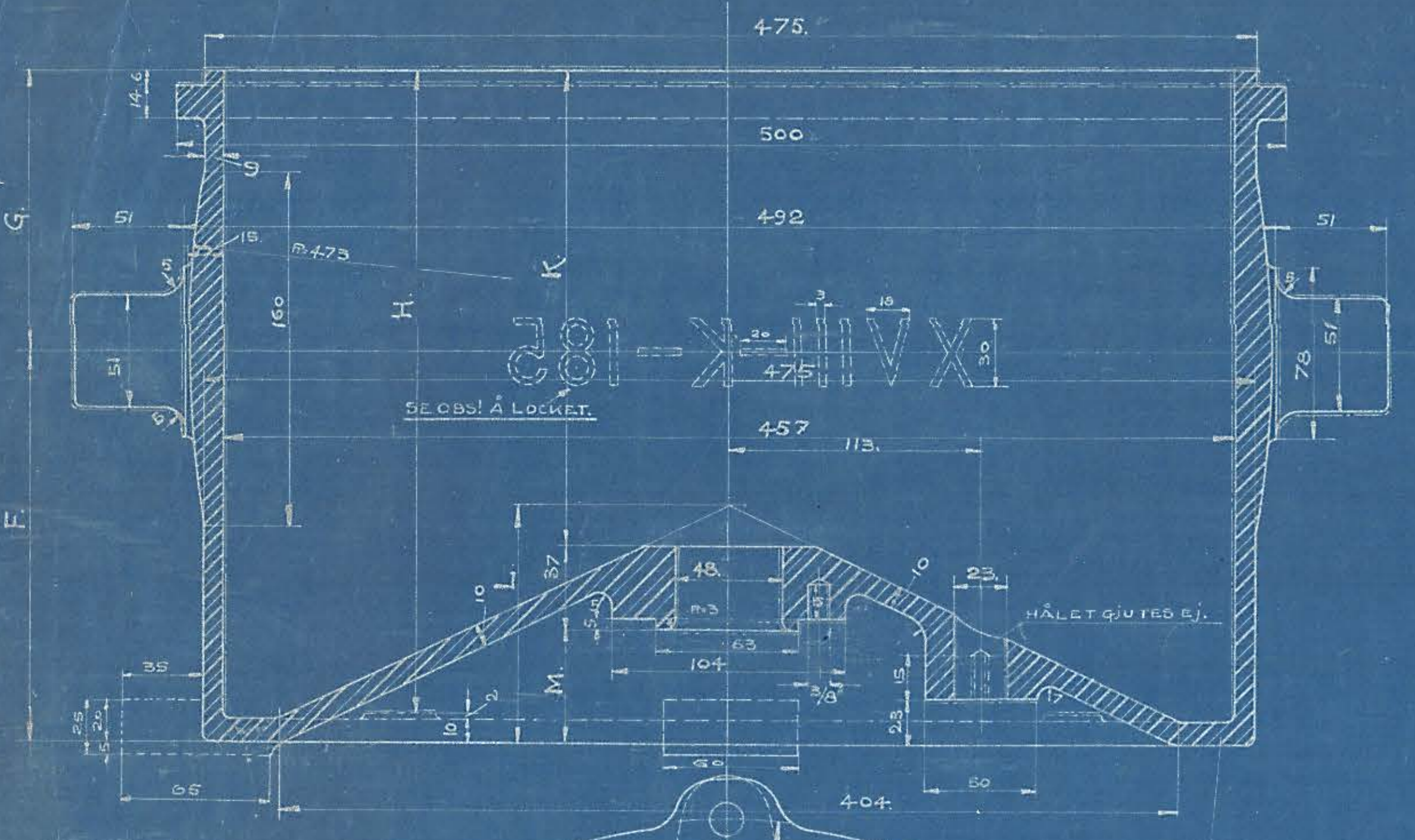

ANTAL:

BEST. NO	BESTÄLLARE	185% SLAG	220% SLAG	300% SLAG	ANM.	MATERIAL
310	T.M.W.		200			
1076-8						
1079						
1080						
1101-2	KÖBGRINGSTÅR					

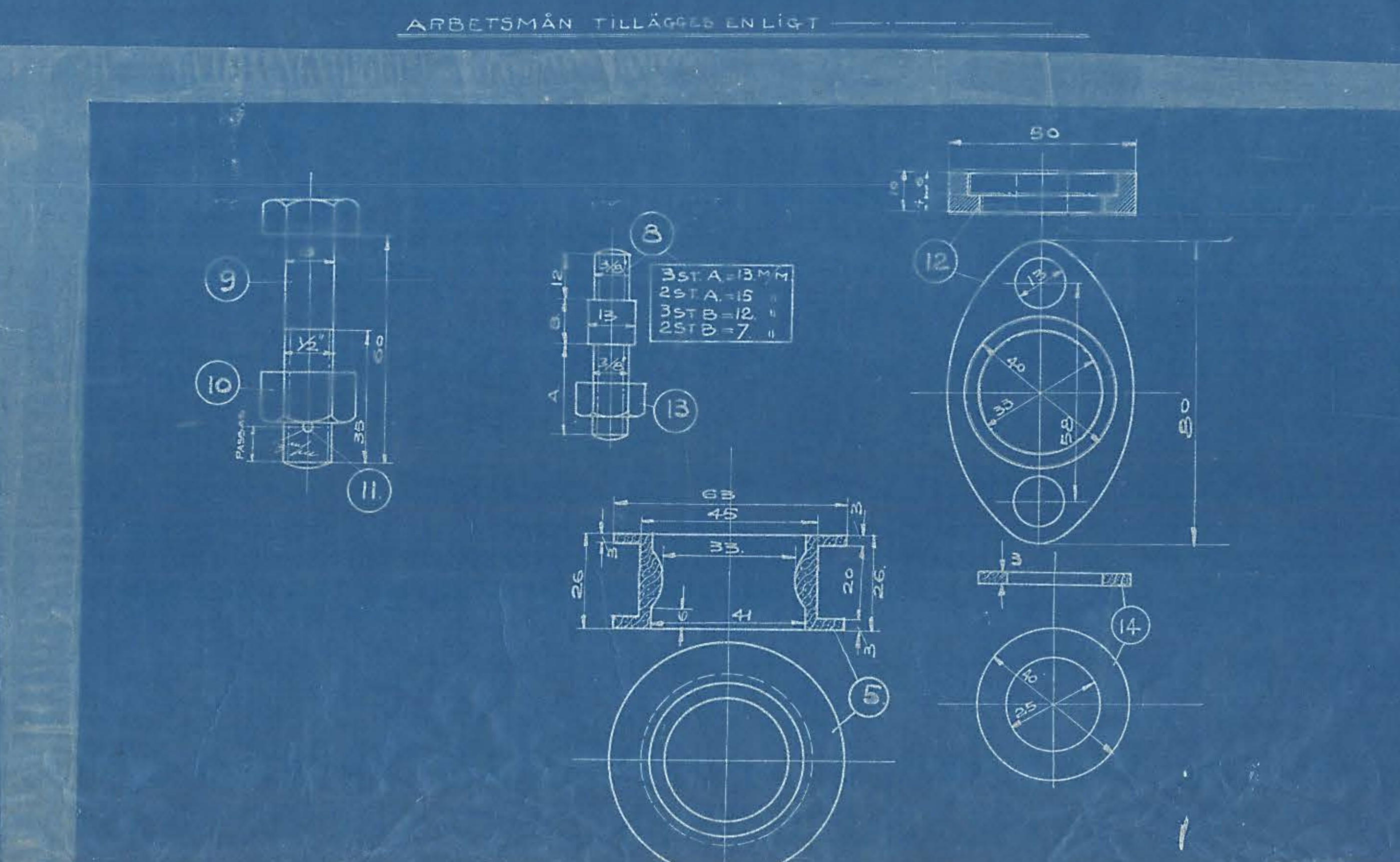
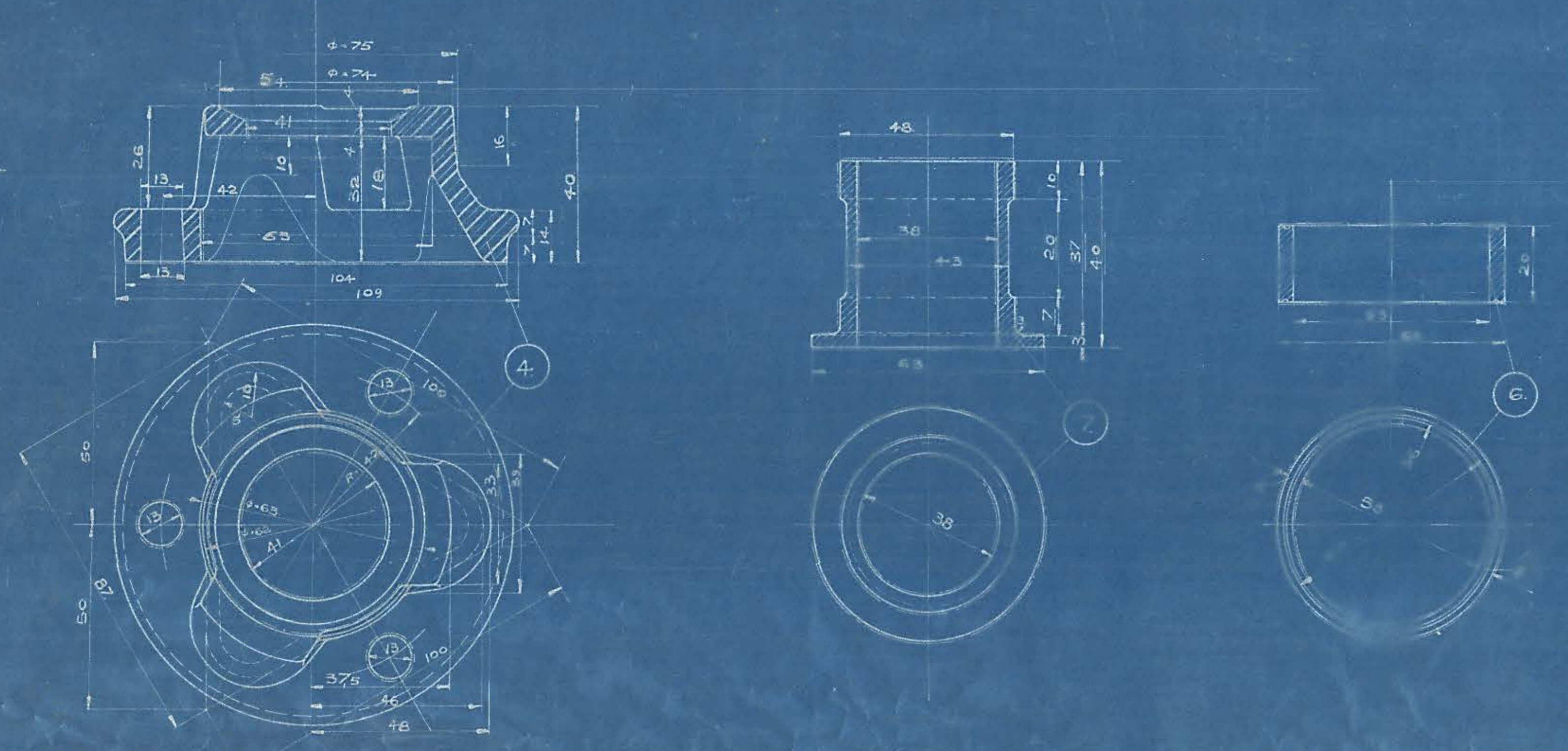

ARBETSMÅN TILLÄGGES ENLIGT

FULL LOKOMOTIV

**D. 12814.**

VACUUMBROMSCYLINDER 18K.

185, 220 & 300% SLAG

T.M.W. & S. O. S.

J. P. Vallberg