

1960.

HAKON GJERSEM
Handels- og Ingeniørfirma
RAADHUSPLADSEN 7, KØBENHAVN V., TLF. PALÆ 3193

STONE'S

SINGLE BATTERY

EXTERNALLY REGULATED

TRAIN LIGHTING SYSTEM

S 300/T2



973 / 40

GENERAL DESCRIPTION & MAINTENANCE

II 9874/51



PUBLICATION No. 973.

"TONUM" SINGLE BATTERY TRAIN LIGHTING SYSTEM

INCORPORATING

CONTROL PANEL TYPE: S80/T2 or S300/T2

WITH

GENERATOR REGULATOR OF THE DUAL
(CURRENT & VOLTAGE) TYPE

(WITH LAMP RESISTANCE DIVERTER)

GENERAL DESCRIPTION

(No. 973/A0)

J. Stone & Company Limited

TELEPHONE:
TIDeway 1202
(16 lines)

Registered Offices & Works:
DEPTFORD
LONDON, S.E.14

TELEGRAMS:
"Tostones Nucros,
London"

TELEPHONE:
WHitehall 9683
(5 lines)

Branch Works:
CHARLTON, LONDON
S.E.7
London Office:
OCEANIC HOUSE
1a COCKSPUR St. S.W.1

TELEGRAMS:
"Oceanilla,
Lesquare, London"

“Tonum” Single Battery Train Lighting System.

The principal components of this system are :—

- (i) A generator suitable for external regulation.
- (ii) A Control Panel, on which are mounted :—
 - (a) An auto Cut-in Relay.
 - (b) A Cut-in Contactor.
 - (c) A dual (Current and Voltage) Regulator.
 - (d) Current and Voltage Adjusters.
- (iii) A Single Battery of Accumulators.
- (iv) The necessary lamps, fittings, switches and accessories.

DISTINCTIVE FEATURES.

The system is well adapted to meet the varying conditions of train lighting service, and is entirely automatic in operation.

The Generator is controlled by a regulator of the dual type which adapts the output to service requirements.

The regulator is designed in such a way that the battery is charged at constant current until it is in a nearly fully-charged condition, from which state the regulator changes over automatically from constant current to constant voltage. This is achieved by independent current and voltage controlling mechanisms.

The accompanying performance curve shows a typical instance of the Dual Regulator when used with a “Tonum” Generator and a suitable battery of accumulators.

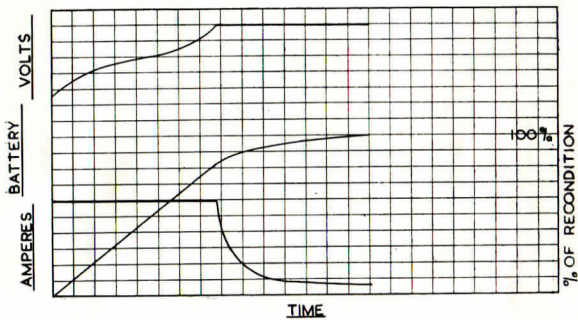

TYPICAL CURVE OF PERFORMANCE



GENERAL.

The characteristics of the system are summarised as follows:—

- (1) A discharged battery is recharged at the maximum rate until the voltage indicates the approach of the fully charged condition.
- (2) Excessive gassing is prevented by the appropriate reduction of final charge rate. This reduces loss of electrolyte and (in the case of lead cells) of active material from the plates.
- (3) The method of charging results in maximum battery life.
- (4) Satisfactory lamp voltage regulation is maintained with varying lamp load.
- (5) The controlling apparatus is simple and definite in operation.
- (6) Full protection to lamps and all parts of the equipment is ensured in the event of accidental break in the battery circuit.

The accompanying diagrams show the essential elements of the equipment and scheme of connections, and from these the fundamental simplicity of the equipment will be appreciated.

In a service with long aggregate stopping periods and heavy demands on the battery, the generator would be running for a substantial proportion of the generating time under the conditions indicated at the left-hand portion of the curve, i.e., producing full current at the appropriate voltage to re-charge the battery as rapidly as possible. In a favourable service with infrequent stops and less demand on the batteries the generator would be working for the larger part of its generating time under the conditions indicated at the right-hand side of the curve, charging the battery at constant voltage with progressive reduction in charging current.

In this manner, the regulator automatically controls the output of the generator to suit service requirements.

The generator is never subjected to overload even though the battery may be fully discharged, with all lamps and load in constant use.

This control of output to varying service requirements is effected entirely automatically and preliminary settings are confined to known requirements of load, battery characteristics and generator rating.

The operation is briefly as follows :—

When the generator is at rest, both Cut-in and Regulator Relays are in the open position and the main contactor in the " OFF " position. The Generator is disconnected from the battery ; under these conditions the lamp resistance is short circuited so that the lighting current may be taken direct from the battery.

When the train accelerates and the Generator has developed the required Cut-in voltage, the Cut-in Relay operates, closing its contacts, thereby operating the Cut-in Contactor. Under these conditions the Generator is connected to the battery, the lighting load being taken through the lamp resistance.

It will be observed that the Regulator Voltage Coil is connected to the battery side of the Cut-in Contactor. Therefore, the Regulator is not attempting to control the Generator voltage prior to cut-in, although the Regulator Carbon Pile is connected in the field circuit.

If the lights are " OFF " the Regulator voltage coil is connected to the battery when the Generator voltage reaches a low value, by operation of the Regulator Relay (REL).

When the lights are " ON " the Regulator coil is always connected to the battery ; and it follows from this arrangement that with a battery of average standing voltage the Carbon Pile (P/I) is fully compressed before cut-in, irrespective of the cut-in voltage. If the battery is just off charge and standing at a high voltage, and the Regulator operating at less than this value, the Regulator pile (P/I) will be fully open, and prevent cut-in until the battery voltage has fallen to the Regulator setting.

To accommodate any value of maximum lamp load it is only necessary to adjust the lamp resistance in accordance with the accompanying Lamp Resistance Chart.

During charging the generator regulator functions to impose suitable control of the generator output.

When the train slows down, and the generator voltage falls below that of the battery, the Cut-in Relay opens by virtue of a normal series coil. Hence the Cut-in Contactor opens, disconnecting the generator from the battery and cutting out the lamp resistance so that lighting current is obtained direct from the battery.

It will be seen from the connection diagram that the lamp switch is provided with auxiliary contacts whereby part of the resistance in series with the shunt coil of the regulator is short-circuited when the lamps are "ON." The effect of this is to cause the regulator to operate at a rather lower voltage. The generator voltage, however, is raised with increase of lamp load to a degree depending on the lamp resistance drop and the selected tapping point of the Voltage Dividing Resistance (VDR), except when position 4 of resistance (VDR) is chosen. At the same time the lamp voltage will fall with increase in lamp load, except where position 1 of resistance (VDR) is chosen. The most popular setting of resistance (VDR) is position 2; for a 24-volt system the lamp resistance drop at full lamp load would be 3 volts with performance as follows:—

| <i>Lamp Load.</i> | <i>Limiting Voltage at Panel Terminals</i> | |
|-------------------|--|--------------|
| | <i>Battery</i> | <i>Lamps</i> |
| Full | 29 | 26 |
| One lamp only ... | 27 | 27 |

mark.

With a discharged battery, the regulator operates at constant current corresponding to the full load rating of the generator. This current value is constant whether lamps are "ON" or "OFF," so that with lamps "ON" the entire generator output, less the lamp load, is available for charging the battery. This is a very valuable feature of the dual regulator system as it ensures the generator capacity being utilised in the most advantageous manner.

The Regulators described in this publication are of the Dual operating type in which independent magnet systems impose initially constant current and ultimately constant voltage upon shunt wound Train Lighting Generators, and should not be confused with Regulators having single magnet systems and Compound Windings which can only provide progressively falling current with rising battery voltage.

CONTROL PANEL COMPONENTS.

TYPE S.80/T2 and S.300/T2.

The panel is shown in outline on the accompanying drawing, and is arranged for mounting in a cupboard inside the carriage. The various components of the panel have been designed to meet onerous Railway conditions, and are consequently unaffected by vibration, etc.

The limiting value of generator voltage can be varied by adjustment of the voltage selecting resistance which will be observed beneath the hinged cover on the Panel. Settings can thus be chosen to suit the service and the type of battery. The outstanding features are :—

Regulator (R).

- (1) Compact design of self-contained unit construction.
- (2) Special fin-cooling arrangement for carbon piles.
- (3) Laminated magnet systems with contoured armatures.
- (4) Frictionless bearings for clappers, which require no oil or grease.
- (5) Exposed carbon piles to permit of easy inspection.
- (6) Visual resetting indicators, enabling the regulator to be reset without the use of instruments.
- (7) Piles can be easily replaced.
- (8) Diaphragm type damping device which has no rubbing parts.

Cut-in and Regulator Relays (CIS and REL).

- (1) These relays are of the snap-action type, ensuring positive action.
- (2) They are sensitive devices, operating consistently within fine limits.
- (3) Large contacts of special alloy are provided, giving long life.

Cut-in Contactor (CTR).

- (1) The contactor is made up as a self-contained unit for direct mounting on the panel.
- (2) Heavy copper contacts are used throughout.
- (3) The contacts are easily removable for replacement.
- (4) The contacts are definitely located, so that adjustment is unnecessary.
- (5) The clapper is easily removable as a unit for inspecting or cleaning of contacts.

STONE'S ELECTRICAL INSTALLATIONS.

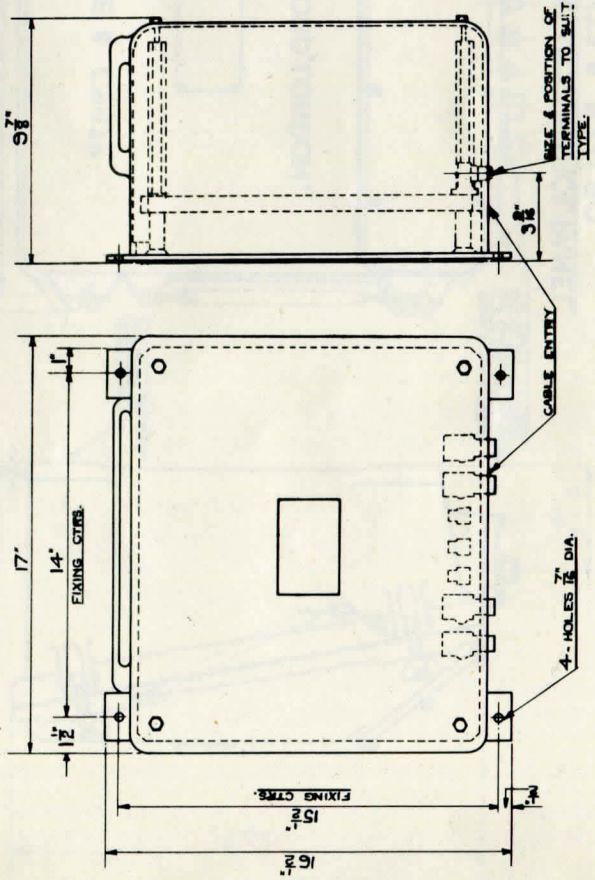

OUTLINE ARRANGEMENT OF :-
CONTROL PANEL

TYPES. S.80/T2, S.300/T2, & F2/L80

ENCLOSURE - PROTECTED

STONE'S ELECTRICAL INSTALLATIONS

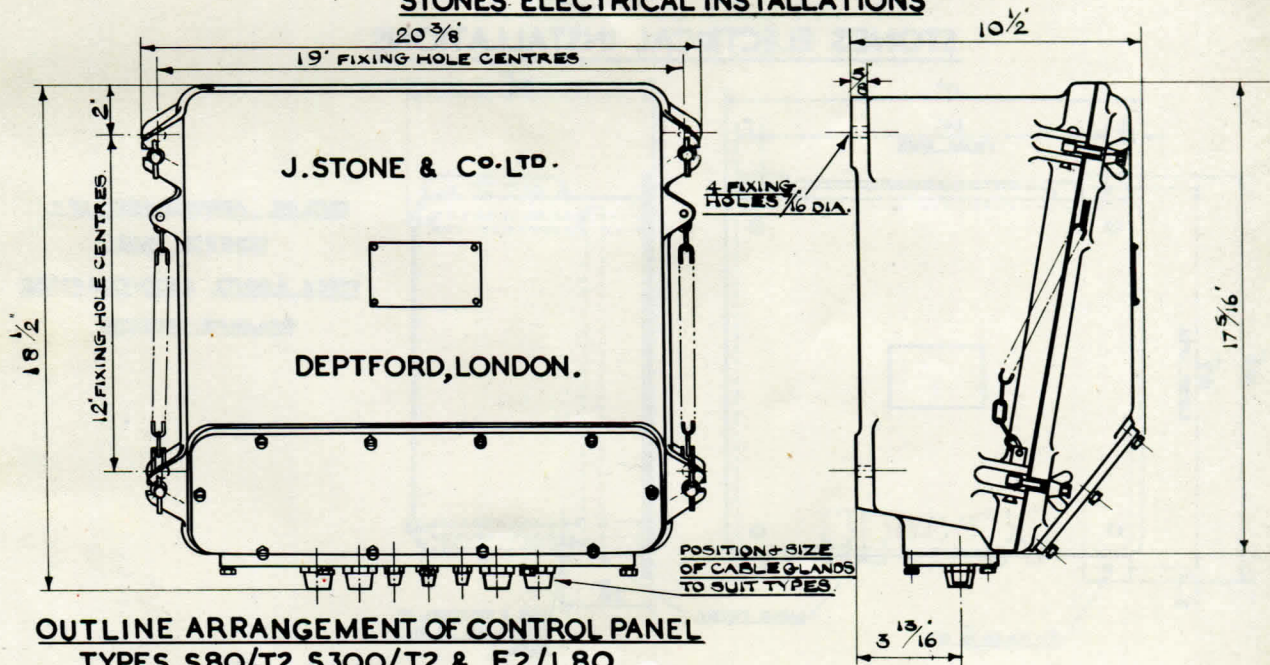

OUTLINE ARRANGEMENT OF CONTROL PANEL
TYPES S.80/T2, S.300/T2 & F.2/L80.
ENCLOSURE:-TOTALLY ENCLOSED.

The Safety Link.

By means of this link, all the apparatus can be isolated from the battery so that examination and cleaning of contacts, etc., can be conducted without risk of damage, under stationary conditions.

Series Coil Shunt.

A Calibrated Series Coil Diverter may be fitted according to the requisite generator output. Shunts can be supplied to cover a wide range of Generator outputs, all being clearly marked with the operating current value.

Voltage Selecting Resistances.

Adjustable resistances are provided with access from the front of the panel, for the following adjustments to be made:—

(a) *Voltage Selector Resistances (VSR).*

For selection of limiting voltage with lights off, to suit the type of battery.

(b) *Lamp Voltage Selector Resistance (LVS).*

For selection of limiting voltage with lights on.

(c) *Voltage Dividing Resistance (VDR).*

This is provided with a link and 4 tapping points, in order that the most acceptable conditions of battery re-charge and lamp voltage regulation may be obtained. The link is positioned on the panel between the Resistances VSR and LVS. Position 1 will give the best lamp voltage regulation, while position 4 gives the best battery charging at all lamp loads. Position 2 and 3 give intermediate results, position 2 being generally recommended.

Fuses :

Two fuses are provided and mounted on the front of the panel:—

A field fuse (FUS/1) to protect the Generator field and the system against failure of "cut-in."

An additional fuse (FUS/2) is also provided for the protection of the Voltage Dividing Resistance (VDR) in the event of the lamp resistance becoming open circuited.

These fuses are made in two distinct sizes to avoid confusion in replacement.

“TONUM” CONTACTOR TYPE SWITCHGEAR.

The use of this type of switch-gear has now been standardised by J. Stone & Company in all their train lighting equipments and the following essential features will be appreciated when considering the troubles which must have been experienced with the laminated type of brushes which have been in use for so many years.

All contacts are renewable and made from extruded solid drawn copper section, identical in size, and so are completely interchangeable with each other; each is definitely located and fixed in its seating by one fixing screw with lock washer: they engage after impact with rolling and sliding action to ensure intimacy of contact; one of each pair is independently sprung and the bracket on which it is mounted is sufficiently free on its mounting to permit perfect alignment on engagement.

The current carrying capacity of any contact is largely a function of pressure. In Stone's "Tonum" contactors, adequate contact pressure is provided by magnetic pull for the "on" contacts and by a substantial spiral spring for the "off" contacts.

The amount of pressure developed by spring loading at the bottom contacts and by magnetic attraction at the top contacts is identical. Extremely low voltage drop in the connections is ensured by the provision of substantial braided conductors securely clamped to the moving contacts, which are entirely insulated from the contactor framework.

The hinged carriers or clappers on which the moving contacts are mounted are constructed of mild steel plate and are strongly pulled to the "off" position by a spiral spring; they are effectively insulated from all circuits and supported on the magnet yoke by a phosphor bronze hinge pin.

The contacts are very accessible and readily removable.

“TONUM ” CUT-IN RELAYS.

It has been found essential with contactor type switch-gear, to incorporate a master controlling relay in order that positive and snap action may be ensured.

The principles on which this works are similar to those of the conventional “cut-in” switch, but as the current to be transmitted through the contacts is only that required to energise one contactor shunt coil, the dimensions are correspondingly reduced, and a very neat, compact and efficient relay has been produced.

The operation is effected by two coils, a shunt coil connected direct to the generator terminals which closes the relay at the appropriate voltage, and a series coil to carry the maximum generator current—the latter assists the shunt coil while the machine is generating, and effects the prompt opening of the relay contacts by its demagnetising effect immediately the speed falls and the battery tends to discharge through the generator.

The relay has been designed so that the operations of “cut-in” and “cut-out” are decisive, the armature and contacts closing or opening with a quick action ; hesitation is not possible even under the severe conditions of vibration met with in service. Moreover, the use of delicate springs has been avoided and the armature has low inertia in relation to the actuating forces, so that the necessary accuracy of operation is not upset by vibration.

The contacts are renewable and are made from a special spark resisting alloy.



THE "LILIPUT" DUAL REGULATOR TYPE L/T2.

The "Liliput" Minor Dual Regulator has been designed to provide complete and entirely automatic control of shunt wound Train Lighting Generators.

Fundamentally the regulator is an automatic shunt field regulator of the Carbon Pile type and the unit comprises two separate magnet systems (mounted on a common base) each controlling its own carbon pile, the piles being connected in series with each other and the shunt field of the generator.

The need for skilled attention has been reduced to a minimum; maintenance is largely confined to superficial examination for mechanical defects. Any minor adjustment that may be required can be effected under stationary conditions and without the use of electrical instruments.

The carbon piles are not enclosed and can be readily inspected at all times, by merely removing the cover of the regulator.

One of the magnet systems is provided with a current winding connected in series with the Generator to ensure the initial limitation of generator output at constant current, whilst the other is provided with a shunt winding connected across the generator terminals to provide the ultimate constant voltage.

From the foregoing remarks it will be appreciated that the regulator consists of a double carbon pile rheostat controlled by separate magnet systems sensitive to Current Output and Terminal Voltage. The state of compression of the carbon piles is determined by the magnet systems which work in opposition to their respective control springs. Normally the carbon piles are held in a state of compression (corresponding to minimum pile resistance); any current or voltage in excess of the predetermined value will extend either control spring, and at the same time decrease the pressure on the respective pile, thereby increasing its resistance.

At the correct current or voltage the spring force is in balance with the magnet and pile forces at all positions of the armature, i.e., the system is astatic and will automatically set itself to whatever pile resistance happens to be required to ensure the correct current or voltage.

It will thus be seen that the magnet movement under the influence of its respective operating coil is in opposition to the control spring, and the pile will be either compressed or de-compressed until the Current or Voltage is restored to normal.

Each magnet system has two slots into which two armature tongues are attracted; these tongues are mounted on a "Y" shaped clapper which is carried on cross spring hinges providing frictionless bearings. The control spring is also attached to the clapper so as to compress the pile and oppose the magnet pull. The armature is so shaped that the pull of the magnet at the correct current or voltage varies linearly with armature movement so that the characteristic can be readily matched by that of the control spring.

The control Spring of the Voltage Regulator only is mounted from a strip of bi-metal for the purpose of temperature compensation; this bi-metal is clamped to the magnet system and deflects so as to strengthen or weaken the spring as may be required according to the temperature.

The necessary correcting force to ensure stability is obtained by the incorporation of Air Compression diaphragm type dashpots, which are carefully set at the time of manufacture, and no attempt should be made to effect any further adjustment. The dashpot on the voltage magnet is spring connected for the purpose of quick response.

It sometimes happens that a settling down process occurs (particularly in transit) in which Carbon Piles tend to shorten slightly. This contingency is catered for by a pile resetting indicator. If adjustment is necessary this is indicated by two white lines being out of alignment, and requires merely a simple mechanical adjustment. These two lines are marked at the works when the regulators are set, and it is only necessary to observe occasionally this alignment and follow the simple instructions given in the form of an engraved label mounted on the outside of the regulator cover.

The accompanying Drawing illustrates the general arrangement of the regulator when panel mounted for Train Lighting application, and the wiring connections are shown in the diagram.

MAINTENANCE INSTRUCTIONS.

REGULATOR TYPE L/T2.

The Regulator is a precision instrument and it is our earnest recommendation that no part of this apparatus should be interfered with unless the indications are that the service is not being maintained in the manner prescribed in the accompanying General Description of the system.

Reference to the panel and the wiring diagram will show that certain components are provided with a means of adjustment which materially affect the general performance of the equipment, and unauthorised re-adjustment of any of these components should be discouraged unless the need for re-adjustments is obvious and really necessary.

Note.—Before making any adjustments, make sure Battery Isolating Link is open.

The following items have been made adjustable to suit known conditions at the time of installation :—

(1) The Generator Output Series Coil Diverter should be selected for the requisite generator output, which should not exceed the Makers' rated output as given on the Generator nameplate.

(2) **Voltage Selecting Resistances.**

Adjustable resistances are provided with access from the front of the panel, for the following adjustments to be made :—

(a) **Voltage Selector Resistances (VSR).**

For selection of limiting voltage with lights " OFF " to suit the type of battery.

(b) **Lamp Voltage Selector Resistance (LVS).**

For selection of limiting voltage with lights " ON."

(c) **Voltage Dividing Resistance (VDR).**

This is provided with a link and 4 tapping points, in order that the most acceptable conditions of battery re-charge and lamp voltage regulation may be obtained. The link is positioned on the panel between the Resistances VSR and LVS. Position 1 will give the best lamp voltage regulation, while position 4 gives the best battery charging at all lamp loads. Positions 2 and 3 give intermediate results, position 2 being generally recommended.

- (3) At the top of the Regulator unit will be found a small Variable Resistance (VAR) operated by a slotted screw ; this means of adjustment is provided for use at the main depot and solely for the purpose of re-establishing the original setting to compensate for any slight variation in voltage that may have taken place in the mechanism, as the result of a long period of service.
- (5) On the back of the panel will be found a Voltage Calibrating Resistance (VCR) and this is made variable mainly, to make the calibrated scale of the Voltage Selector Resistance (VSR) on the front of the panel, coincide with the ultimate constant voltage actually obtained.

Pile Resetting.

During storage and in the first few weeks of use, it sometimes happens that a " settling down " process occurs in which the pile tends to shorten slightly, and simple instructions are provided for this contingency in the form of an engraved label fitted on the regulator cover. After a short time the pile should settle down and the necessity for this adjustment should become less frequent.

TO RESET :—

Regulator to be shut down and cold.

- (1) UNLOCK CLAMP PLATE by SCREW Marked RD.
- (2) TURN ADJUSTING NUT with SCREWDRIVER UNTIL WHITE SCRIBE MARKS ARE IN LINE.
- (3) RELOCK CLAMP PLATE.

This adjustment moves the pile adjustable screw referred to in the Description.

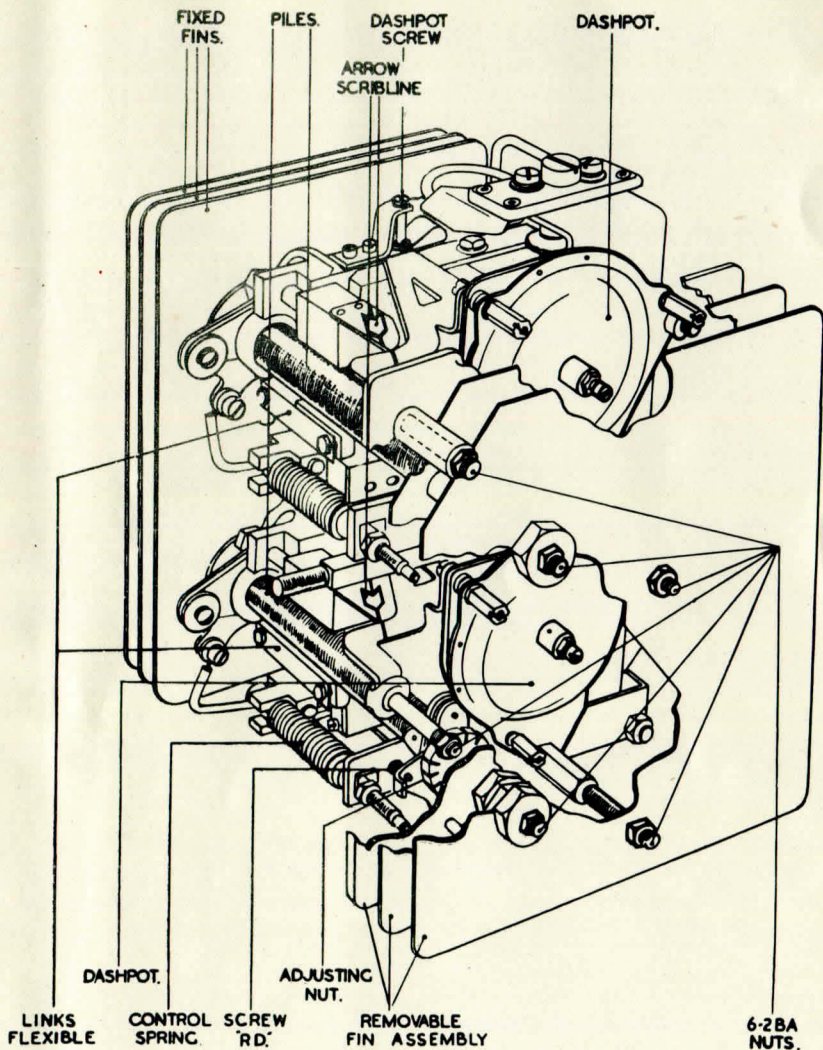

LILIPUT DUAL REGULATOR
TYPE L/T2



THE UNIVERSITY OF CHICAGO
LIBRARY

Pile Examination and Replacement :

From time to time the pile should be examined by running the finger nail along the surface. If the pile is in good condition, it will appear to have a feeling of gritty hardness ; if, however, the carbon rings appear to be soft so that the nail will sink in with ease, they should be replaced by a new set of elements.

To replace the carbon pile :—

1. Open the battery isolating link.
2. Remove the six 2BA nuts from the studs which secure the right-hand fin assembly.
3. Remove the right-hand fin assembly by drawing it off the mounting studs.
4. Slide the damaged carbons off their insulating tube.
5. Take a spare pile assembly and remove the cap securing the rings.
6. Apply the spare pile assembly so that the end of the rod holding the rings slips on to the end of the copper core of the pile mounting of the regulator.
7. Slide the new rings on to the regulator pile mounting.
8. Check that the overall length of these rings when held firmly is as near as possible 80 mm. (3.15").
9. Replace the fin assembly, with washers and nuts, and tighten nuts.
10. Close battery isolating link.
11. Reset the regulator so that the scribe marks are in line.

Note :—It is of the utmost importance that spare carbon rings should be of the correct grade and size. Replacements are supplied in containers holding a few more rings than are actually required, and it is necessary to discard only sufficient rings to ensure pile resetting in accordance with the instructions given under this heading.

When ordering spares the Specification Number of Regulator should be quoted, and the makers cannot guarantee the performance of the regulator if carbon pile replacements are obtained elsewhere.

Damping :

The necessary correcting force to ensure stability is obtained by the incorporation of the air compression diaphragm type dashpot which will have been carefully set by the manufacturers, and no attempt should be made to effect further adjustment. In the event of obvious instability or " hunting " in the regulator

movement, the dashpot may have sustained mechanical damage, in which event a complete and adjusted dashpot should be obtained and substituted.

Don't tamper with the Air Control Screw as Air Valve has been adjusted ready for use before leaving the manufacturers.

To see if a Dashpot requires replacement :—

Run the finger over the edge of the rubber diaphragm overlapping the rim of the dashpot. If it feels of a rubbery nature the dashpot is fit for a further period of service, but if it feels hard or looks perished then a new dashpot should be substituted.

To remove the Dashpot :—

1. Open battery isolating link.
2. Remove the BA nuts from the studs which secure the right-hand fin assembly.
3. Remove the right-hand fin assembly by drawing it off the mounting studs.
4. Slacken captive screw which links dashpot compression plate with operating rod.
5. Release the three 6BA hexagonal pillar nuts and Thackeray washers fixing dashpot to regulator frame and withdraw dashpot.

To Fit a New Dashpot :—

1. Take a new dashpot from container and place dashpot on fixing studs so that captive screw lines up with the hole in operating rod. Move clapper by hand to line up dashpot operating rod with hole in bush on dashpot compression plate, then push dashpot home.
2. Replace the three 6BA hexagon pillar nuts and Thackeray washers and tighten.
3. Move the clapper by hand all the way in, then tighten the captive screw.
4. Replace fin assembly and tighten nuts.
5. The carbon pile should now be reset, if necessary, in accordance with the instructions given under the heading " Pile Re-setting."

Note :—At the conclusion of these operations do not forget to replace and tighten the battery isolating link.

MAINTENANCE INSTRUCTIONS.
“TONUM ” CUT-IN CONTACTOR.
TYPES U.80 and U.300.

Contactors :

Open safety link and switch off battery loads. The contacts should then be removed and cleaned by means of a clean rag soaked in petrol. Any contacts which are burnt should be replaced, after which they should be lightly smeared with vaseline. (See Spare Part List). 34/1/1

The flexible braided connections should be examined and if necessary, renewed. (See Spare Part List).

The pin holding the pull-off spring on the armature framework should be pulled out of its slots and the armature hinge pin removed. This should be examined for wear and if necessary, replaced by a new pin lightly smeared with vaseline. (See Spare Part List).

A. To renew Contacts or Contact Springs :

This can be done without dismantling switch.

1. Remove fixing screw holding contact assembly to be renewed.
2. When replacing the contacts, great care should be taken to see that the contact is secure on its base and the fixing screw tight.

B. To renew Braid Assembly :

1. Remove braid assembly fixing screws.
2. Remove contact fixing screws.
3. Replacement should be in reverse to the removal operations, care being taken to see that the braid is not distorted.

Important : Before replacing braids clean all contact surfaces, i.e., braids, terminal pillars, contactor contacts, etc., with emery cloth.

C. To remove Clapper Assembly :

1. Remove braid securing screws.
2. Release spring pin.
3. Remove clapper fixing screws. Clapper with contacts and braid can then be removed.
4. These operations should be repeated in reverse when the clapper is replaced, and it is only necessary to see that all screws and the release spring pin are secure and in position.

Important : Do not remove clapper hinge pin.

D. To remove Coil :

1. Remove clapper assembly as for (C).
2. Take off dished spring washer.
3. Disconnect connections to coil terminals.
4. Withdraw coil.
5. The new coil can now be fitted, and the above operations repeated in reverse.

NOTE : Do not forget to replace Safety Link.

| DIMENSION | A | | B | | C | | D | | E | |
|-----------|-------------------|----------|-------------------|-----------|--------------------|-----------|----|-----------|-------------------|-----------|
| TYPE U80 | 2" | 50.8 Mm. | 4 $\frac{7}{8}$ " | 112.7 Mm. | 9 $\frac{5}{8}$ " | 244.5 Mm. | 4" | 101.5 Mm. | 3 $\frac{1}{4}$ " | 82.55 Mm. |
| TYPE U300 | 2 $\frac{1}{8}$ " | 54 Mm. | 6 $\frac{1}{4}$ " | 159 Mm. | 11 $\frac{1}{8}$ " | 282.6 Mm. | 4" | 101.5 Mm. | 4 $\frac{7}{8}$ " | 113 Mm. |

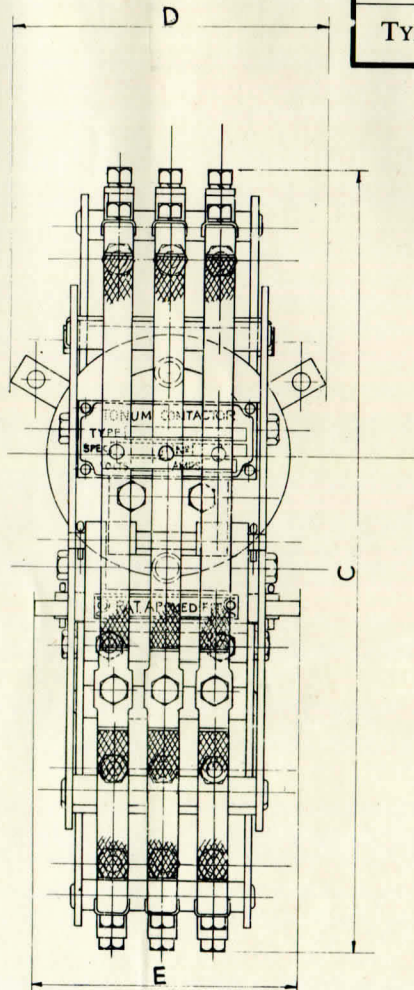

NO. OF CONTACTS, IN BOTH ON AND OFF POSITION, SUBJECT TO VARIATION TO SUIT INDIVIDUAL REQUIREMENTS.

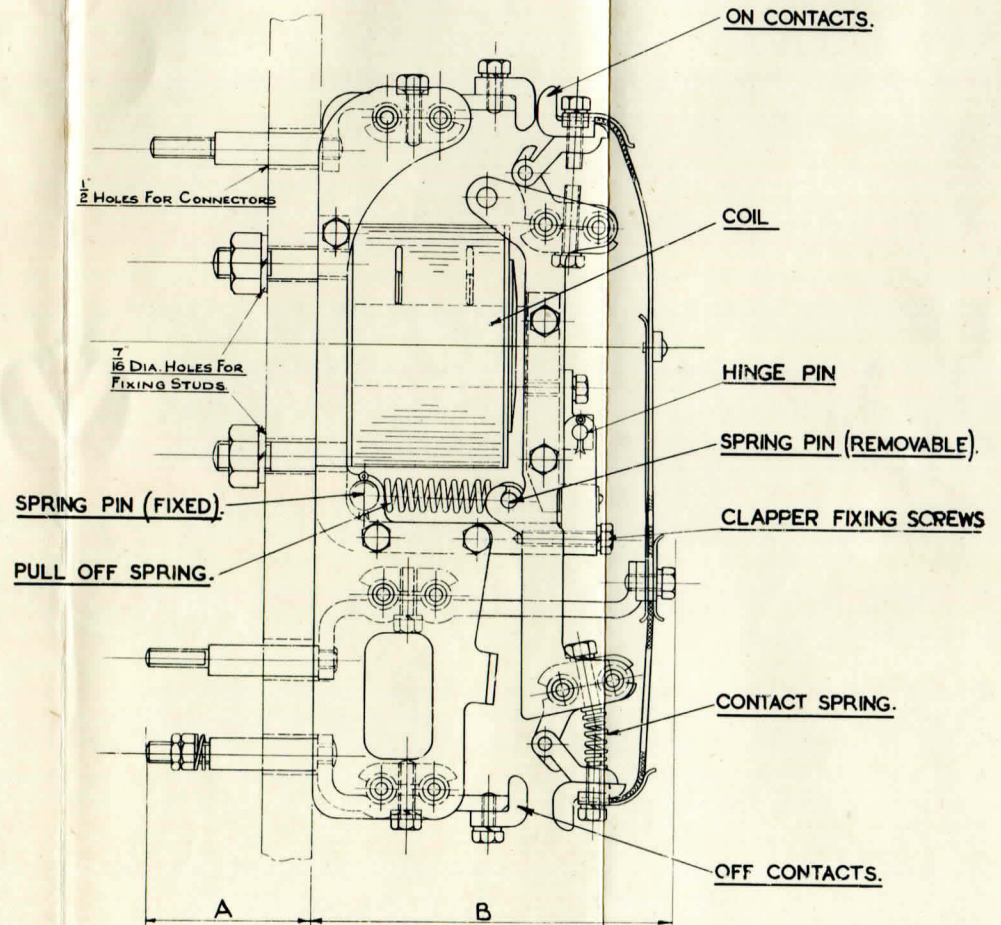

"TONUM" CONTACTOR
TYPE. U.

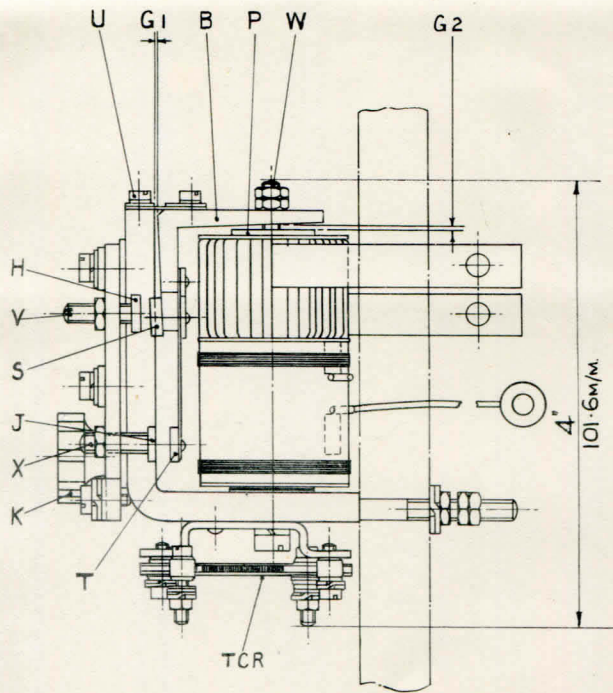

"TONUM" RELAYS
 TYPES UR & UM

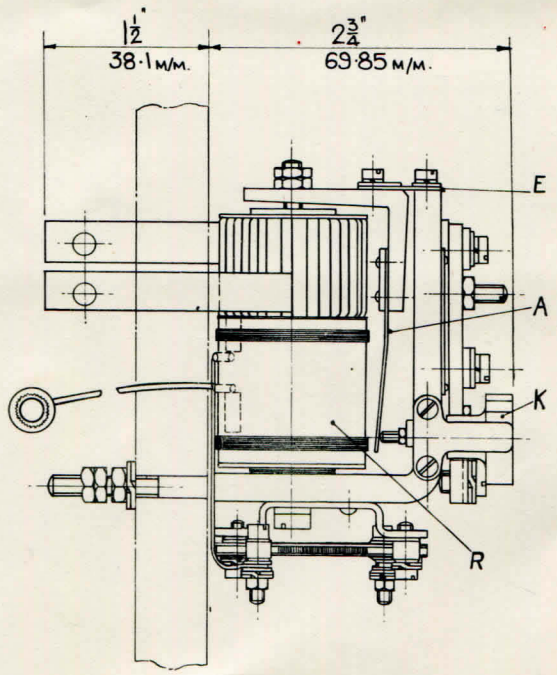

WIDTH OF RELAY, 2", 50.8m/m (CLEAR)

MAINTENANCE INSTRUCTIONS.

RELAYS, TYPE UR. and UM.

Before carrying out any adjustments or replacements, make sure the battery is isolated from the panel.

The contacts should be examined and, if necessary, replaced by new ones.

If the contacts do not require replacement, they should be cleaned with a clean rag soaked in petrol.

Shunt and series winding are side by side on one core, and must be replaced as a "coil and core" assembly. To replace, remove relay from panel, then remove screws holding armature hinge to yoke "U", and nuts "W" and lift off armature "B." Remove screw at bottom of yoke holding core, and lead from shunt coil to T.C.R. Coil and core assembly can now be completely removed.

When the coils have been replaced, or if it is suspected for any other reason, that the operation of the relay is defective, it should be reset.

It is very important when replacing a core and coil assembly that the original shims are carefully replaced.

Setting Cut-in Relay.

To set the cut-in relay, the shunt coil should be energised from a variable voltage supply, and the voltage selecting screw set at the mean indicated voltage. The spring tension should then be adjusted by the small adjusting screw concentric with the main voltage selecting screw until the switch closes at the correct voltage. Always make sure the locknut is tight after making an adjustment. Check operation of switch at Cut-in and Cut-out.

The action of the relay should be rapid and decisive on both opening and closing. If this is not the case, it should be assumed that the various gaps have not been correctly set, and the whole procedure outlined above should be repeated. The accompanying diagram shows the standard dimension for setting the air gaps.

Hinge Gap G.1 ... 0.04in. — Screw “ U ”

Core Gap G.2 ... 0.010in. (Switch closed)—Screw “V”

Core Gap G.2 ... 0.050in. (Switch open) — Nut “W”

Auxiliary Contacts to touch when core gap is 0.030in.—Screw “X”

Thumbscrew “K” is for adjusting the tension of Control Spring
“A” for setting the cut-in voltage.

Warning :—Do not interfere with gaps as these are accurately set in J. Stone & Co.’s works and any alteration will jeopardise the correct functioning of the relay.

MAINTENANCE INSTRUCTIONS.

TONUM GENERATORS.

(A) MAINTENANCE IN TRAFFIC.

Regular periodical examination of the generator in position should be made every three months, and the more important points to which attention should be given are as follows:—

(1) **The Rocker Gear.**

This should be examined to see that it moves freely to its stop in response to the friction of the brushes on the commutator, when the armature is rotated by hand. The flexible braids should be examined and connections tightened.

- (2) Thoroughly clean all parts and again ensure that the Rocker moves freely.
- (3) See that the Brushes are free in their holders, and suitable for service for at least three months. It is important that only the correct type and grade of carbon brush, as originally supplied with the machines, is used, as stamped on nameplate.
- (4) Tighten all connections.

(B) OVERHAUL IN SHOP :

The generator should be examined in detail to detect any irregularities, among which the following may be mentioned :—

Yoke.

All dust, grease, oil or water should be carefully wiped from the face of the poles and particularly from the bottom of the inside of the yoke. Field coil connections should be checked for security and soldering.

Armature.

Examine binding bands for slackness and, if necessary, re-wind with tinned Steel Pianoforte Wire as follows :—

For armatures above $4\frac{1}{2}$ " dia.—·036 Gauge 20 S.W.G.

For armatures up to and including $4\frac{1}{2}$ " dia.—·024 Gauge 23 S.W.G.

Note :—Pure tin solder must be used for soldering all armature connections and also binding wires.

MAINTENANCE INSTRUCTIONS.

TONUM GENERATORS.

(A) MAINTENANCE IN TRAFFIC.

Regular periodical examination of the generator in position should be made every three months, and the more important points to which attention should be given are as follows:—

(1) **The Rocker Gear.**

This should be examined to see that it moves freely to its stop in response to the friction of the brushes on the commutator, when the armature is rotated by hand. The flexible braids should be examined and connections tightened.

- (2) Thoroughly clean all parts and again ensure that the Rocker moves freely.
- (3) See that the Brushes are free in their holders, and suitable for service for at least three months. It is important that only the correct type and grade of carbon brush, as originally supplied with the machines, is used, as stamped on nameplate.
- (4) Tighten all connections.

(B) OVERHAUL IN SHOP :

The generator should be examined in detail to detect any irregularities, among which the following may be mentioned :—

Yoke.

All dust, grease, oil or water should be carefully wiped from the face of the poles and particularly from the bottom of the inside of the yoke. Field coil connections should be checked for security and soldering.

Armature.

Examine binding bands for slackness and, if necessary, re-wind with tinned Steel Pianoforte Wire as follows :—

For armatures above $4\frac{1}{2}$ " dia.—036 Gauge 20 S.W.G.

For armatures up to and including $4\frac{1}{2}$ " dia.—024 Gauge 23 S.W.G.

Note :—Pure tin solder must be used for soldering all armature connections and also binding wires.

Ball Bearings.

These bearings give no trouble providing the lubricating grease used is suitable and care is taken to prevent the ingress of dirt and grit and, while V.O. Co.'s "Gargoyle" Grease B.R.B.3 is recommended for use in all temperate climates, it is advisable to make a careful selection of grease lubricant, after practical trials, in all cases where extremes of temperature have to be met.

The bearings should be thoroughly cleaned approximately every eighteen months, all old grease should be removed, and the bearing thoroughly cleaned, first with paraffin and then with petrol; since if paraffin remained it would adversely affect the lubricating properties of the new grease to be added.

Carefully examine the balls and races, and, if in order, apply the selected grease; work it well into the ball race channel to fill it thoroughly, adding sufficient grease to fill the grease chamber and cap **half** full.

Do not use more grease than indicated above; excessive grease will find its way into the interior of the machine where it will encourage the accumulation of carbon dust, and is liable to cause overheating of the bearings.

The grease should be kept in a covered receptacle and well protected from grit and moisture. A grease containing solid matter such as graphite must not be used, as it will cause rapid wear of the balls and races.

Under normal working conditions these ball bearings give no trouble, but should one become loose in its housing, the housing should be rebushed to standard and a new ball bearing fitted; slackness of the ball bearing on the shaft may in exceptional circumstances also occur. In this case the shaft should be built up, machined to standard and a new ball bearing fitted; the practice of knurling the shaft should not be resorted to. Ball bearings should not be removed from their shafts except when it becomes necessary to renew them.

Commutator.

The commutator should be kept clean; normally it presents a dark burnished appearance and only requires dusting, but if it

is blackened by sparking, the cause must be ascertained and remedied; the brushes may require attention, or there may be a loose connection; either will result in bad electrical contact.

To polish the commutator, fine glass paper only should be used and this may be applied stretched on a wooden block shaped to the contour of the commutator; if this is done the machine may be motored for the purpose of polishing.

Should it be found necessary to true up the surface of the commutator, grinding with a carborundum wheel is recommended in preference to turning, after which the mica should be undercut $\frac{1}{32}$ ". The maximum permissible radial wearing depth of the commutator is as follows, and the commutator should be replaced if its diameter becomes less than the minimum permissible figure given below:—

| <i>Original Diameter.</i> | <i>Permissible Wearing Depth.</i> | <i>Minimum Permissible Diameter.</i> |
|---------------------------|-----------------------------------|--------------------------------------|
| $7\frac{5}{8}$ " | $\frac{3}{8}$ " | $6\frac{7}{8}$ " |
| $6\frac{1}{2}$ " | $\frac{5}{16}$ " | $5\frac{7}{8}$ " |
| $5\frac{3}{4}$ " | $\frac{5}{16}$ " | $5\frac{1}{8}$ " |

The Rocker Gear.

This should be examined to see that it moves freely to its stop in response to the friction of the brushes on the commutator, when the armature is rotated by hand. The flexible braids should be examined and connections checked.

Brush Boxes.

The adjustment of brush boxes is necessary whenever the commutator has been ground or new commutator fitted. The clearances between the brush box and the commutator surface are:—

| <i>Width of Brush.</i> | <i>Distance of Brush from Commutator.</i> |
|------------------------|---|
| 1" | $\frac{1}{16}$ " to $\frac{1}{8}$ " |
| $\frac{5}{8}$ " | $\frac{1}{32}$ " to $\frac{3}{32}$ " |

Carbon Brushes :

The Carbon Brushes (and Brush-gear) should be kept clean and free from carbon dust, particular care being taken to ensure that they make good contact on the commutator and that they will move up and down smoothly in the holder. Should the contact surfaces have become irregular they should be ground with glass paper to the contour of the commutator, all carbon dust being removed on completion.

It is important that only the correct type and grade of carbon brush, as originally supplied with the machine, is used. (As shown on the brush guide given on the name-plate).

Suspension Gear and Alignment.

The alignment of the generator pulley with the axle pulley, and the generator shaft with the axle, is most important, and considerable economy can be effected by ensuring that this is correct—malalignment not only affects the life of the driving belt, but also the performance of the generator; a curled or frayed edge on the belt and a polished surface **off** the centre line of the Generator or Axle pulley are indications that adjustments are necessary.

Stone's special adjustable suspension link provides a simple and effective means of making the necessary adjustment.

Belts.

Always cut the driving belt square and ensure that the belt fastener is fitted true; a suitable die plate for cutting and punching the belt is recommended.

General.

All nuts, bolts and split pins on the suspension gear, generator and axle pulleys should be examined and adjustments made where necessary.

All moving parts on the suspension gear and generator lug should be cleaned and greased.

All electrical connections, both internal and external should be kept clean and tight.

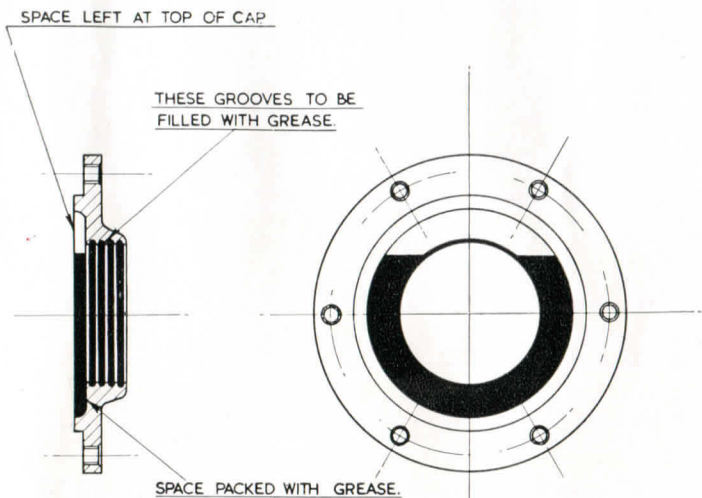

FIG. 1.

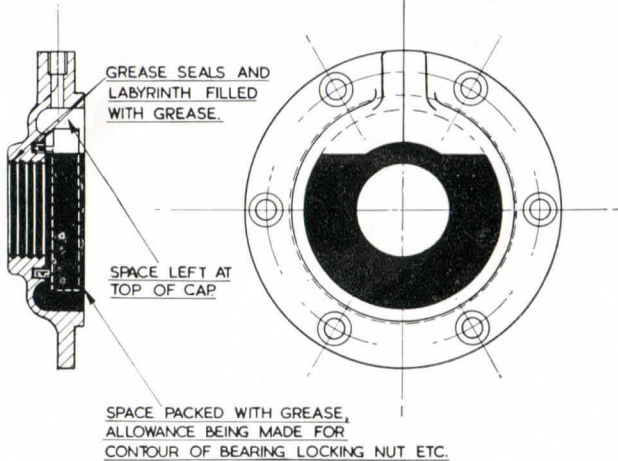
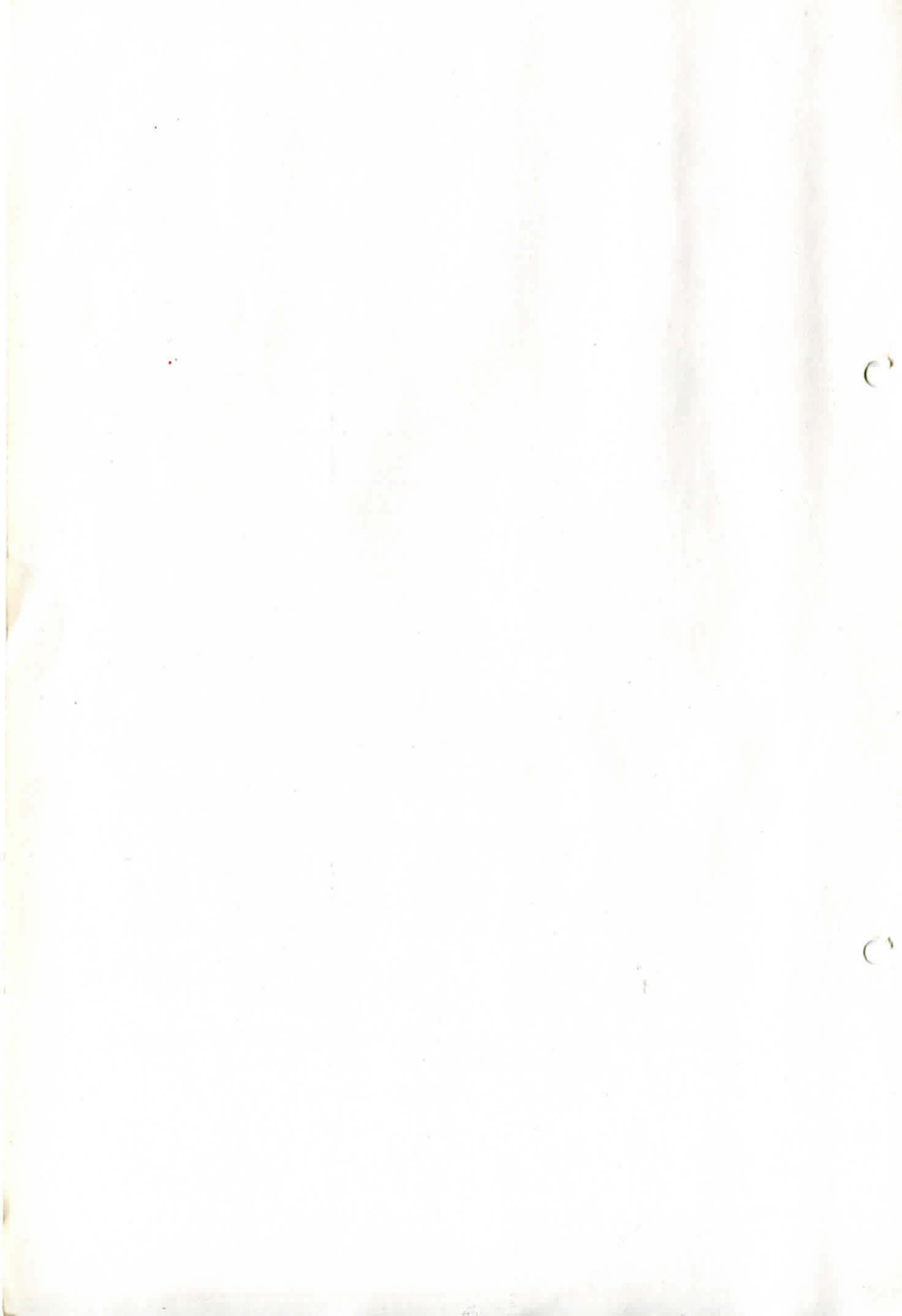

FIG. 2.



MAINTENANCE INSTRUCTIONS.

ARMATURE REMOVAL AND REPLACEMENT.

All Tonum Generator Armatures have been constructed to withstand normal railway service for long periods with minimum attention, and particulars of maintenance whilst in service are given elsewhere, but there may come a time when, owing to mechanical damage, it is necessary to replace the armature in its entirety.

To Remove Armature.

- (1) Remove Belt or coupling.
- (2) Remove the four hexagon headed screws which secure the driving endshield.
- (3) Remove inspection covers from commutator end.
- (4) Lift all brushes and see that they are retained clear of the commutator by the pressure of the fingers.
- (5) The driving endshield can now be loosened from its spigot by inserting two of the hexagon headed screws in the tapped holes provided.
- (6) The armature and the driving endshield can now be withdrawn ; great care should be taken to see that neither stampings, winding nor commutator is damaged by bumping on the pole faces.

It will be observed that the inner race of the commutator end bearing remains on the shaft, and the outer race and cage of rollers are retained in the commutator endshield.

If the Armature is to be re-assembled in the same frame.

If the armature is to go back in the same frame, wipe the inner race of the roller bearing clean before re-assembly ; and, if necessary, re-grease the bearing as described elsewhere in these instructions.

If the Armature is to be re-assembled in a different frame.

It should be noted that the races are not inter-changeable from one bearing to another. If therefore the armature is not to go back in the same frame, it is necessary to remove the outer race and cage of rollers from the commutator endshield and to retain these parts along with the inner race which is on the armature shaft. The inner race should not be removed from the shaft except when fitting a new bearing as it is essential to have a tight fit on the inner race of the shaft, and this would be loosened by excessive withdrawal and refitting.

To remove the Outer Race and Cage of Rollers from the Commutator Endshield.

- (7) Remove the outer bearing cap from the commutator endshield.
- (8) Extract the outer race and cage of rollers by hand manipulation, care being taken to pull with the fingers on both sides simultaneously with a steady and equalised pull in order that the race shall not tip and jam to either one side or the other.
- (9) To keep the outer race and cage of rollers with the inner race to which they belong, they should be placed in position over the inner race and retained by a bearing protector which can be provided for the purpose. This housing also protects the bearing from becoming dirty during storage.

To fit Spare Armature.

Spare armatures are supplied without bearings, as these are best stored in the bearing maker's original pack.

If a spare armature is to be assembled on the machine, it is first necessary to fit the bearings as follows :—

- (10) Commutator end, inner race to be driven on the shaft and secured with washer and circlip provided. Note that an interference fit between the bearing and the shaft is necessary ; if this is not obtained, then the shaft should be built up by a suitable method such as " Fescolising," or a new shaft should be fitted.
- (11) Before fitting the driving end bearing, it is first necessary to place the inner bearing cap over the shaft. The bearing should then be driven on, and the remarks concerning the fit of the commutator end bearing apply in this case also. This bearing should be retained by the nut and tab washer provided, and the tab washer turned over into the appropriate nut groove.
- (12) The outer race and cage of rollers of the commutator end bearing should now be filled with grease (Vacuum Oil Co.'s BRB₃), which should be worked well into the bearing. Grease should also be applied to the grooves of the labyrinth shaft seal and to the inner faces of the bearing caps, which should receive sufficient grease to fill about 2/3rds of the space when assembled. The outer race should now be pushed into position in the commutator endshield.
- (13) The outer bearing cap of the commutator endshield should be secured in position.

- (14) The driving end bearing should be filled with grease worked well into the bearing as described for the commutator end, and the grease applied to the shaft seals and to the inner faces of the bearing caps. The driving endshield and outer bearing cap may now be assembled around the driving end bearing.
- (15) The spare armature may now be assembled in the frame.

If for any purpose the Brush Arms have had to be removed the following instructions should be carefully observed :—

TO CHECK BRUSH SPACING.

A simple method is to wrap a piece of stout paper round the commutator and draw pencil lines where the leading edges of the brushes touch. On removing the paper and measuring the distance between the lines, the spacing can be checked.

Correct Position of Brushes.

If the brushes have been correctly assembled the centre line of the brushes will line up with the centre line of the poles, when the brush rocker is turned against its stops in either direction.

This will give the approximate neutral position and the final setting can be carried out by driving the generator on load at its maximum name plate speed. The generator should be driven in either direction under equal conditions of load, at maximum speed and the field current recorded. If the two values of field current recorded are within $2\frac{1}{2}$ per cent. of their mean value the brush position can be considered to be correct. If the field currents are outside these limits the brushes must be adjusted—slightly forward on the rotation for which the lower field current was recorded and slightly back on the rotation for which the higher field current was recorded until the results lie within the limits.

METHOD OF REMOVING ARMATURE SHAFT.

The following instructions should be observed when a shaft has become bent or damaged in service. Usually this damage is associated with the pulley end, in which case these instructions should be strictly observed, but in the remote contingency of a shaft at the commutator end becoming bent or damaged it will, of course, be necessary to cut off the damaged shaft extension with a hacksaw before removal can be put into effect.

Applicable to machines frame sizes 22S, 22L, 29S, 29L, 32L, 38L, 44S, and 44L.

- (1) Remove Driving Pulley.
- (2) Lift the Generator Brushes.
- (3) Remove Bolts fixing D.E. Endshield to Frame.
- (4) Withdraw the Armature from machine.
- (5) Remove Outer Bearing Cap at D.E.
- (6) Remove D.E. Endshield.
- (7) Remove Locknut from D.E. Bearing.
- (8) Draw off the D.E. Bearing.
- (9) Remove the inside Bearing Cap.
- (10) Remove D.E. Bearing abutment sleeve.
- (11) Remove the Locknut from the Commutator End Bearing.
- (12) Draw off the commutator end bearing and its abutment sleeve.

Note.—The commutator end bearing is a roller bearing and if the work is carried out as indicated above, the outer race and the rollers of the bearing will remain inside the commutator endshield while the inner race will be drawn off the shaft. It is important that the two parts of the bearing should be kept together.

It will now be possible to press out the armature shaft by applying pressure at the commutator end of the shaft by means of a suitable press exerting a force of 25 tons approx. on the 22S, 22L, 29S, 29L frame sizes and 50 tons approx. on the remainder.

To transmit the pressure to the end of the armature sleeve a collar should be fitted over the shaft at the driving end and arranged to bear upon the end of the armature sleeve. The object of this collar is to prevent damage to the armature end windings.

The dimensions of suitable collars for the various sizes of machines are as detailed below.

| <i>Frame Size.</i> | <i>Bore Dia.</i> | <i>Length.</i> | <i>Outside Dia.</i> |
|--------------------|------------------|----------------|---------------------|
| 22S & L | 1.9" | 2" | 2.5" |
| 29S & L | 2.3" | 2" | 3.25" |
| 32L | 2.55" | 3" | 4.0" |
| 38L | 2.9" | 3" | 4.5" |
| 44S & L | 3.3" | 3" | 5.5" |

BATTERIES.

(24-Volt Systems).

The choice of battery is of some importance when considering any train lighting system, and the curves included in this publication show how the voltage may vary from the discharged to the fully charged condition.

The voltage characteristic of the Lead-Acid battery is limited to a 5-volt variation (when on charge) between the discharged and the fully charged condition, and consequently it is possible to provide an economical solution in the form of a simple lamp resistance in conjunction with the progressive voltage variation obtained by the method of Regulator coil connection.

With Nickel-Cadmium accumulators and where 18 cells have been chosen for a 24-volt lighting system, the same arrangements are possible, but where 19 cells have been considered essential, the inclusion of a Lamp Regulator may be desirable under certain conditions.

With Nickel-Iron accumulators, the voltage variation is such that with 18 or 19 cells, the inclusion of the Lamp Regulator is recommended.

The following battery data, dimensions, etc., should be associated with the generator sizes enumerated in the accompanying schedule, but any variation in quantity, size and capacity can be supplied, as requested, depending upon the requirements of the individual railway carriage or class of service.

Lead-Acid cells may be installed individually, since they are supplied with heavy ebonite boxes complete with removable lids and electrolyte level indicating floats.

Nickel-Cadmium or Nickel-Iron cells are supplied in crates containing 2, 3, 4 and 6 cells for the most convenient handling.



LAMP RESISTANCES.

The lamp voltage specified for any train lighting system, depending upon a battery for the source of power supply under the stationary conditions, must inevitably coincide with the standing voltage of the battery. Unfortunately it is fundamental that the voltage of every known type of battery rises with its charging and it is consequently necessary to absorb the excess voltage particularly under the "on charge and fully charged" condition.

There are two Standard Lamp Resistance Coils for 24-Volt applications :—

A. ... 3 Volts at 10 Amps.
~~XXXXXXXXXXXXXXXXXXXX~~

In order that the Lamp Resistance may be devoid of complication these standard coils can be arranged by parallel or series connections to suit any particular lamp load, each coil providing the specified volts drop at the appropriate lamp load. Where the maximum lamp loads are not multiples of this current the approximate voltage can be obtained with the nearest equivalent.

There are two Standard Lamp resistance boxes and these are arranged to accommodate either 4 or 8 coils respectively. In either case the unit is complete with a set of links to make up any combination of the load current specified for the single coil with provision for a double circuit of half and full light working if circumstances should call for this arrangement.

The function of the Lamp Resistance is one of great importance to the operation of the system and great care should be taken to see that it is correctly calibrated in accordance with the instructions given.

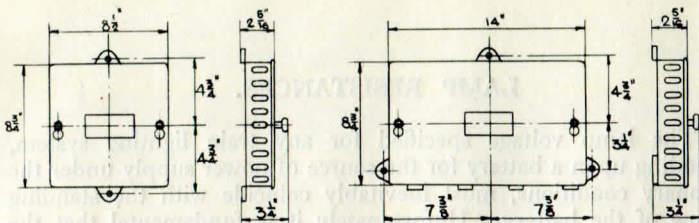

LAMP RESISTANCE BOX & DOUBLE LAMP & AUXILIARY RESISTANCE BOX
ALL FITTED WITH A STANDARD 'EUREKA' RESISTANCE COIL.

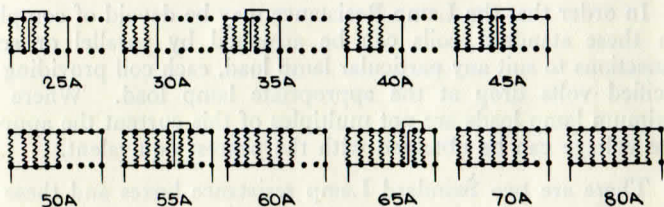

ARRANGEMENTS OF SINGLE CIRCUIT LAMP RESISTANCES IN DOUBLE BOX

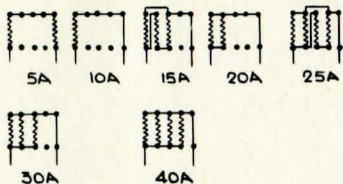

ARRANGEMENTS OF SINGLE CIRCUIT LAMP RESISTANCES IN SINGLE BOX.

STANDARD LAMP RESISTANCES

SINGLE BATTERY TRAIN LIGHTING SYSTEM

"TONUM" CONTROL PANEL

Type S.80/T2 or S.300/T2

*PCF Model
Abn. not shown*

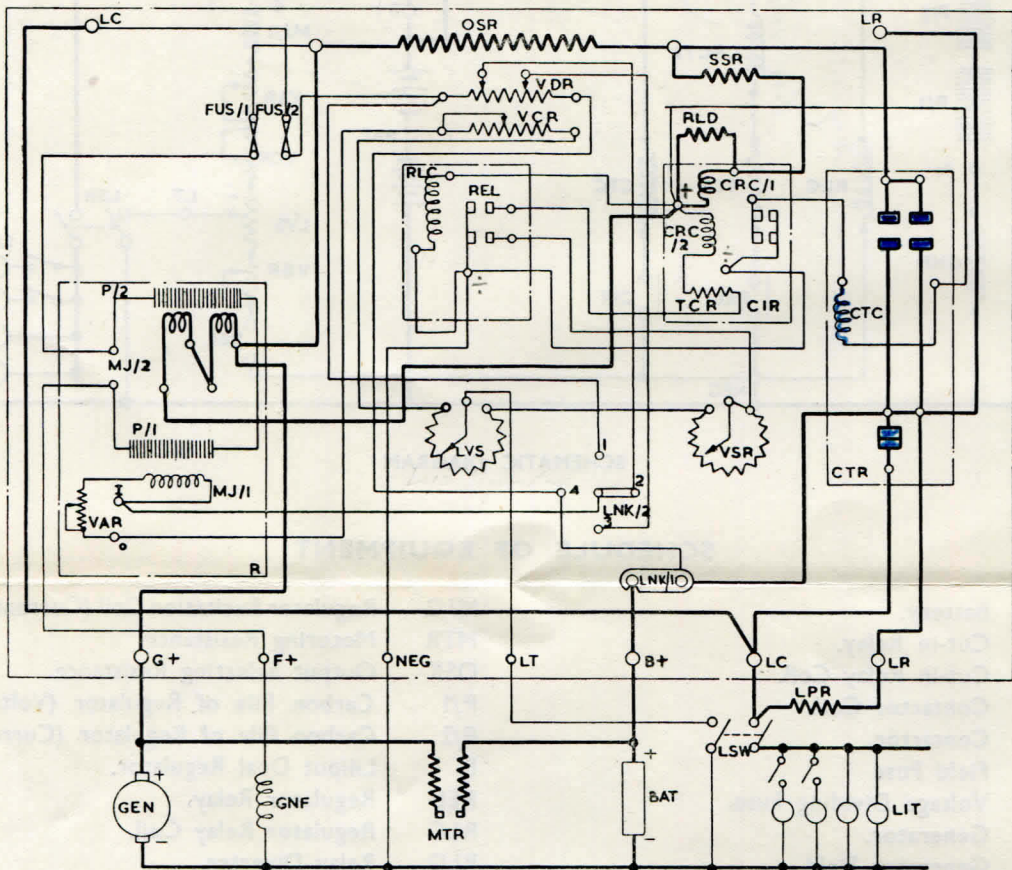

WIRING DIAGRAM

SCHEDULE OF EQUIPMENT

| | | | |
|-------|-------------------------------------|------|-------------------------------------|
| BAT | BATTERY | MJ/2 | REG. EXCITATION COIL (CURRENT SIDE) |
| CIR | CUT-IN RELAY | MTR | MOTORING RESISTANCE |
| CRC | CUT-IN RELAY COIL | OSR | OUTPUT SELECTING RESISTANCE |
| CTC | CONTACTOR COIL | P/1 | CARBON PILE OF REG. (VOLTAGE) |
| CTR | CONTACTOR | P/2 | CARBON PILE OF REG. (CURRENT) |
| FUS/1 | FIELD FUSE | R | LILIPUT DUAL REGULATOR |
| FUS/2 | VOLTAGE DIVIDING FUSE | REL | REGULATOR RELAY |
| GEN | GENERATOR | RLC | REGULATOR RELAY COIL |
| GNF | GENERATOR FIELD | RLD | RELAY DIVERTER |
| LIT | LIGHTS | SSR | SERIES SWAMP RESISTANCE |
| LNK/1 | BATTERY ISOLATING LINK | TCR | TEMPERATURE COMPENSATING RES. |
| LNK/2 | VOLTAGE DIVIDING LINK | VAR | VOLTAGE ADJUSTING RESISTANCE |
| LPR | LAMP RESISTANCE | VCR | VOLTAGE CALIBRATING RESISTANCE |
| LVS | LAMP VOLTAGE SELECTOR | VDR | VOLTAGE DIVIDING RESISTANCE |
| MJ/1 | REG. EXCITATION COIL (VOLTAGE SIDE) | VSR | VOLTAGE SELECTING RESISTANCE |

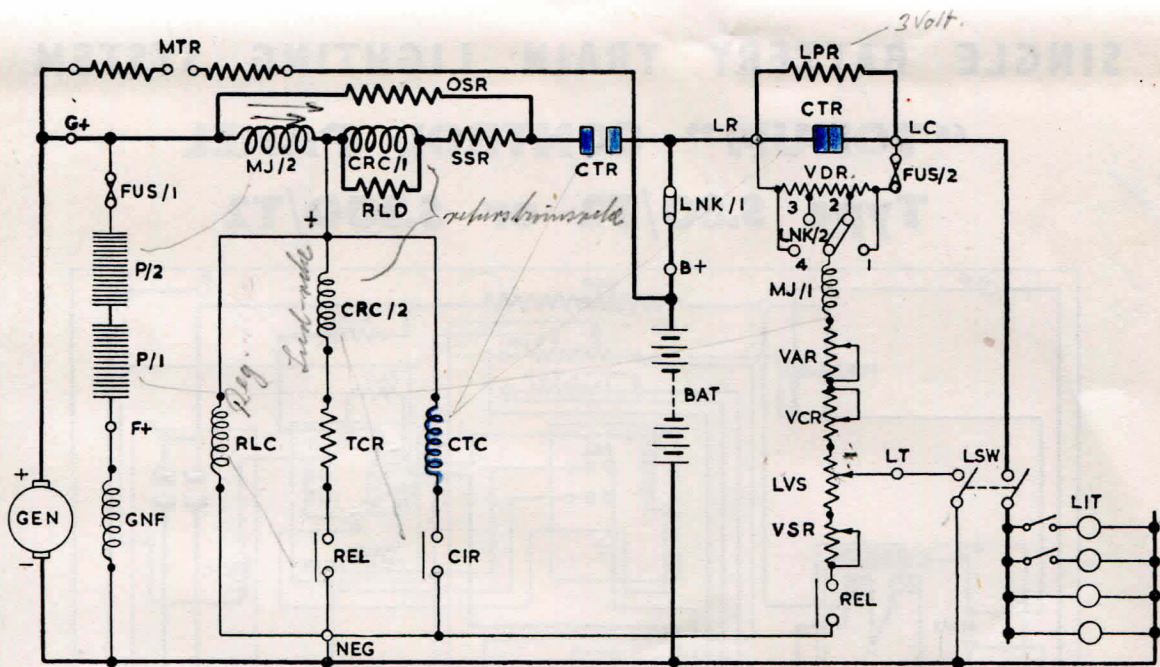

SCHMATIC DIAGRAM

SCHEDULE OF EQUIPMENT

| | | | |
|-------|---|------|---|
| BAT | Battery. | MJ/2 | Regulator Excitation Coil (Current Side). |
| CIR | Cut-in Relay. | MTR | Motoring Resistance. |
| CRC | Cut-in Relay Coil. | OSR | Output Selecting Resistance. |
| CTC | Contactior Coil. | P/1 | Carbon Pile of Regulator (Voltage). |
| CTR | Contactior. | P/2 | Carbon Pile of Regulator (Current). |
| FUS/1 | Field Fuse | R | Liliput Dual Regulator. |
| FUS/2 | Voltage Dividing Fuse. | REL | Regulator Relay. |
| GEN | Generator. | RLC | Regulator Relay Coil. |
| GNF | Generator Field. | RLD | Relay Diverter. |
| LIT | Lights. | SSR | Series Swamp Resistance. |
| LNK/1 | Battery Isolating Link. | TCR | Temperature Compensating Resistance. |
| LNK/2 | Voltage Dividing Link. | VAR | Voltage Adjusting Resistance. |
| LPR | Lamp Resistance. | VCR | Voltage Calibrating Resistance. |
| LVS | Lamp Voltage Selector. | VDR | Voltage Dividing Resistance. |
| MJ/1 | Regulator Excitation Coil (Voltage Side). | VSR | Voltage Selecting Resistance. |

EQUIPMENT DATA SHEET.

Customer: Danish State Rly. J.S. Order No.: A 29199

Customer's Contract No. : Date :

Panel Serial No. :

Type of Equipment: SBXR

Lamp Voltage : 24 NOMINAL

Total Load Current :

Diagram No. DB 320 (typical)

Generator :
Type KR29S to LC1059

Specification T1050

Rated Output 100 A. at 30 V.

Control Panel : S300/T2

Panel Specification : T2315

Voltage Selector Resistance VSR 28/34

Voltage Setting 29

Regulator :
Type L/T2

Specification TR.1175

Carbon Pile Resistance Range : Min 2 ohms Max 60 ohms

Number of Piles : 2

Maximum Watts capacity of piles (at Minimum Resistance 75)

Settings :
Lights Switch Off 29

" " On, but no lamp load 27

" " On, with Full lamp load 29

Shunt Coil Current : 1.0 amp

Series Gen. Series Current (Diverter Clip removed) 40 amps

Lamp Series Coil Current (Diverter Clip removed)

Field Fuse: 0.0092 inches. dia. tinned copper. 6 A.
VDR " ; Cartridge REF; FYVCA. 3 A.

Contactor :

Type U 300
Specification..... T 1797
Maximum Permissible Current :..... 150A
Coil Current :..... -

Relay :

| Type | UR | UM |
|-----------------------------|---------------|------------|
| Specification | T2547 | T2312 |
| Cut-In Voltage | 27 cold | 10 V. cold |
| Cut-Out-Amps. | 2 at 26V. hot | - |
| Shunt Coil Resistance | 32 ohms | 198 ohms |
| Maximum Series Coil Current | 40A. | |

20 ° C. Drg. 8346/1 - Gr.134. Specn. T2073 (8 coils)

Lamp Resistance : DB9

Resistor Coil Rating..... 3volts drop at..... 10amperes.
.....coils in parallel, in parallel with.....coils in series.
Set for 3V. drop at 40 A.

Battery :

Type of Battery :..... 12 Lead Acid
No. of Cells :.....

General Remark : This regulator and control panel is calibrated for use with the Generator Type..... XR 29S.....as specified above.

It must not be used with a generator having a cold resistance less than..... 3.5 ohms.....or output greater than the figure given above.

Important. When ordering spare parts, the specification and serial number of any particular item should always be quoted.

For general description and further details, see Leaflets Nos.....

8.)

Hoveddele i et tøjbelysningsanlæg.

Regulering af batteriets ladning og af lampespenningen.

Daarligt lys under Kørslen.
" " under Stop.

5.)

GFZ - systemet.

Lysstofrørsbelysning

Bosch omformer.

Vekselretter.

(Periødetal.)

3.)

Rosenberg - systemet

i Grundtræk.

Sikringer (alle anlæg)

(Størrelse - formaal - anbrin-
gelse o.s.v.)

G.A. DRAWING NO.

STONE'S ELECTRICAL INSTALLATIONS.

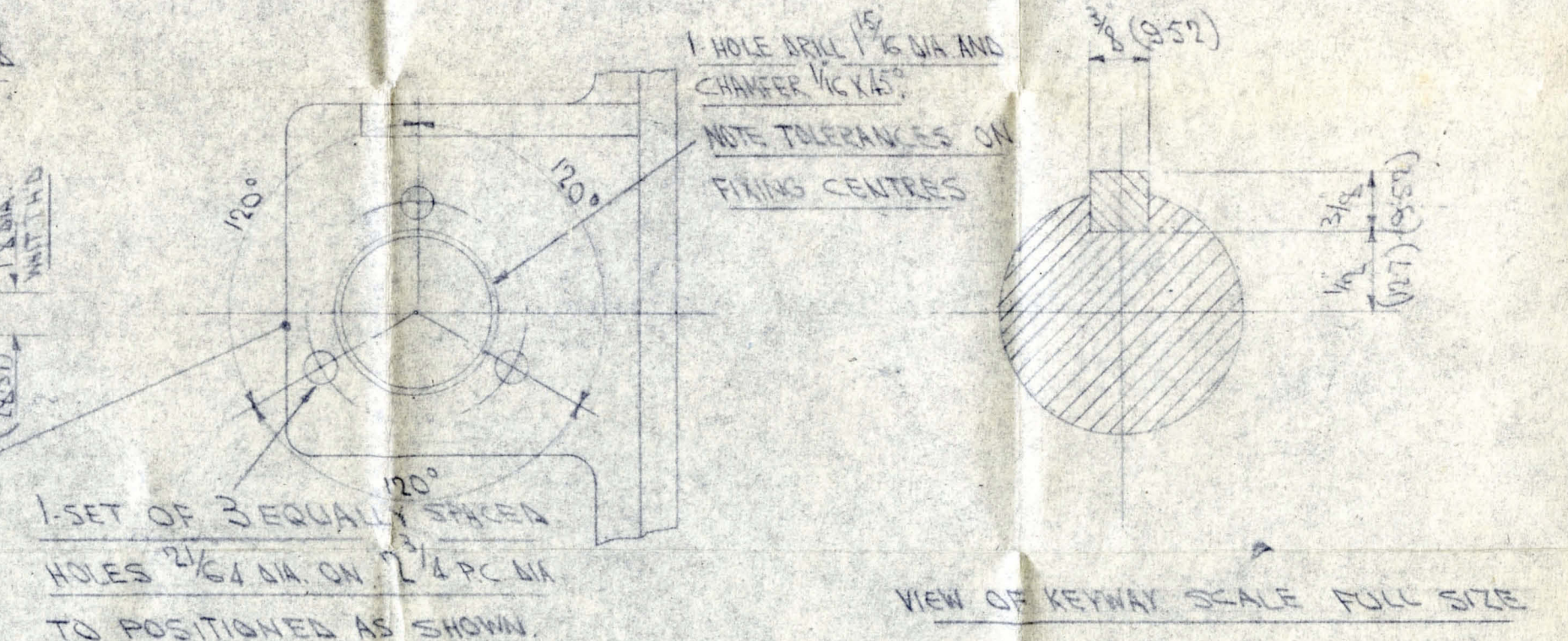
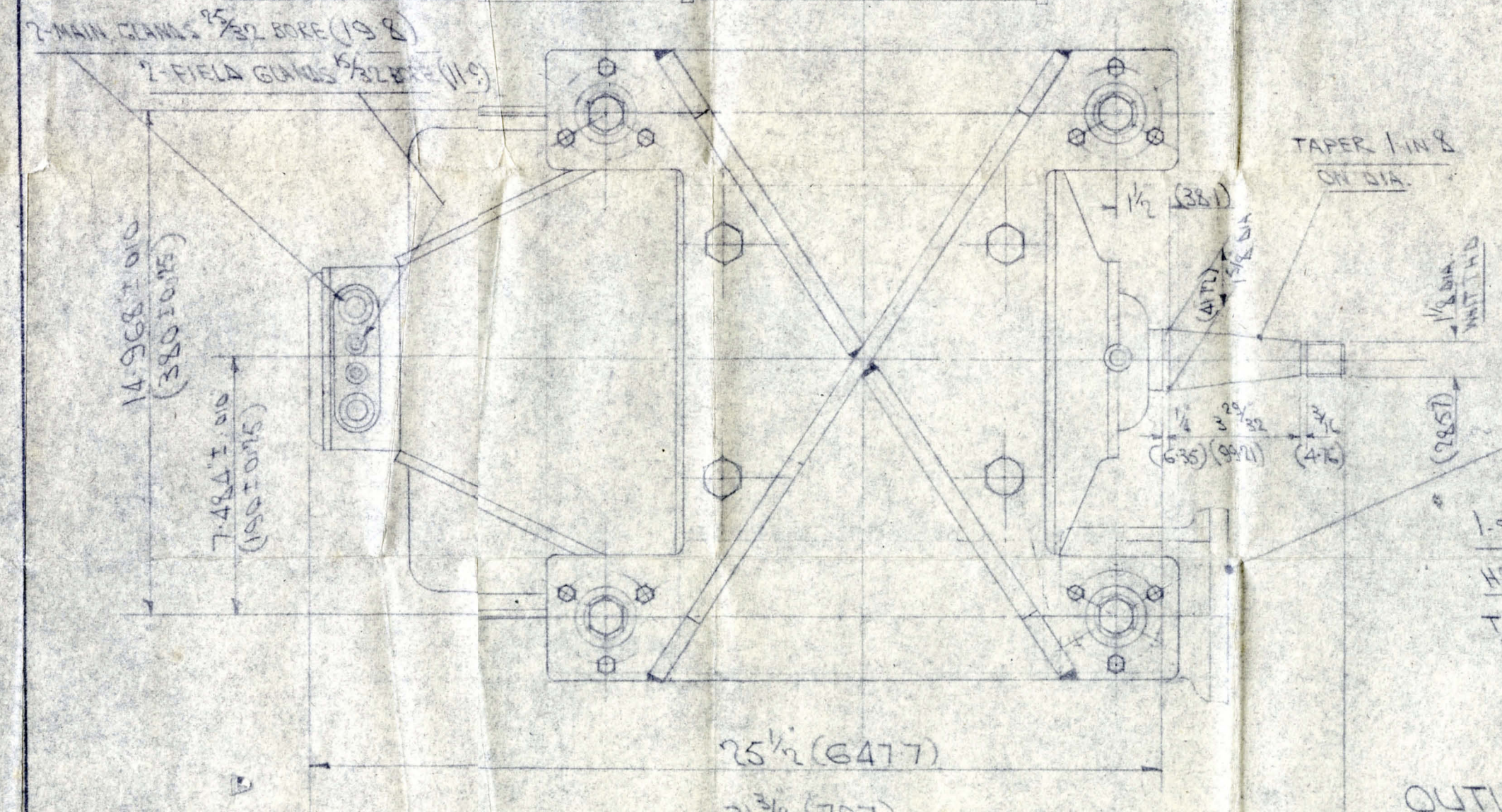
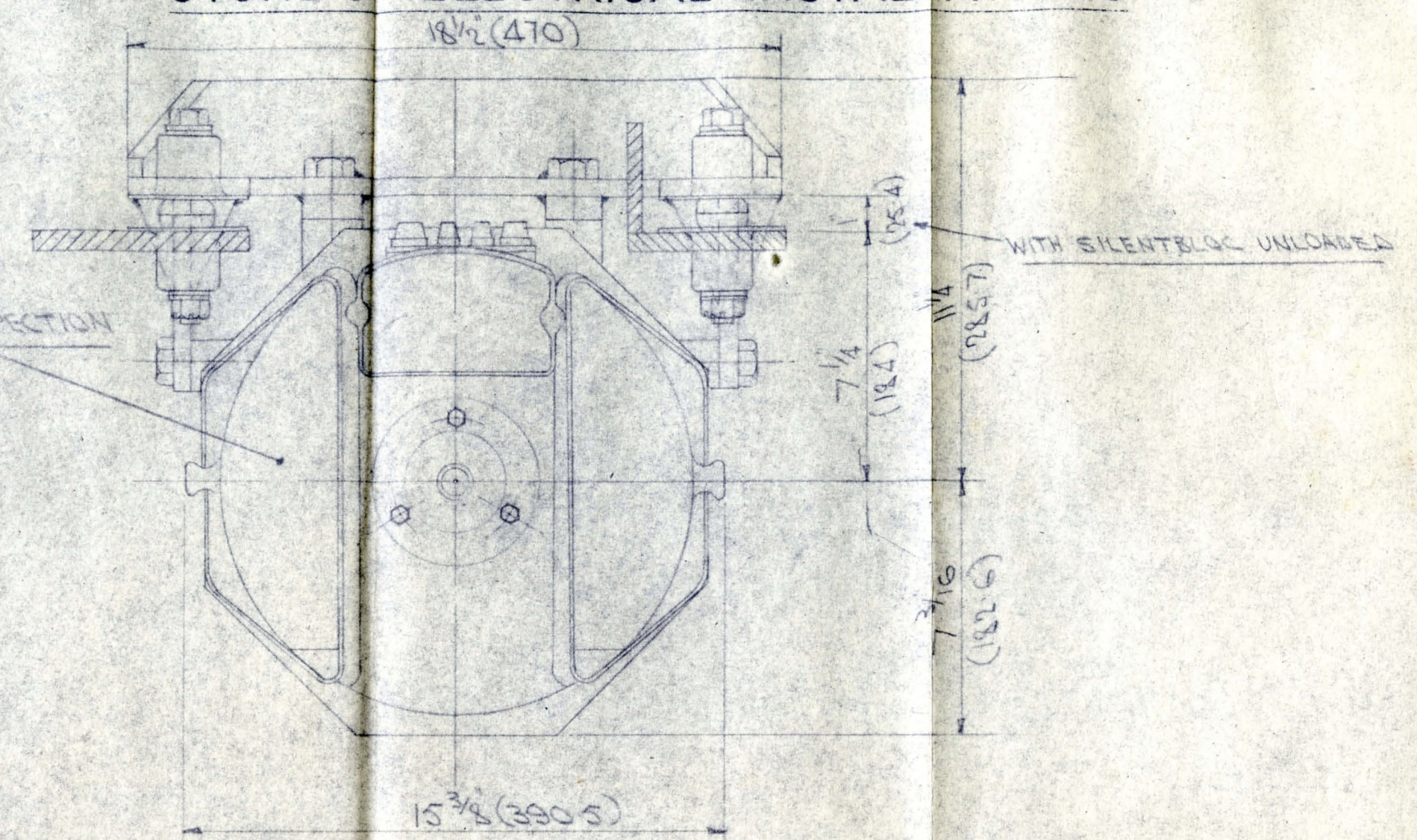
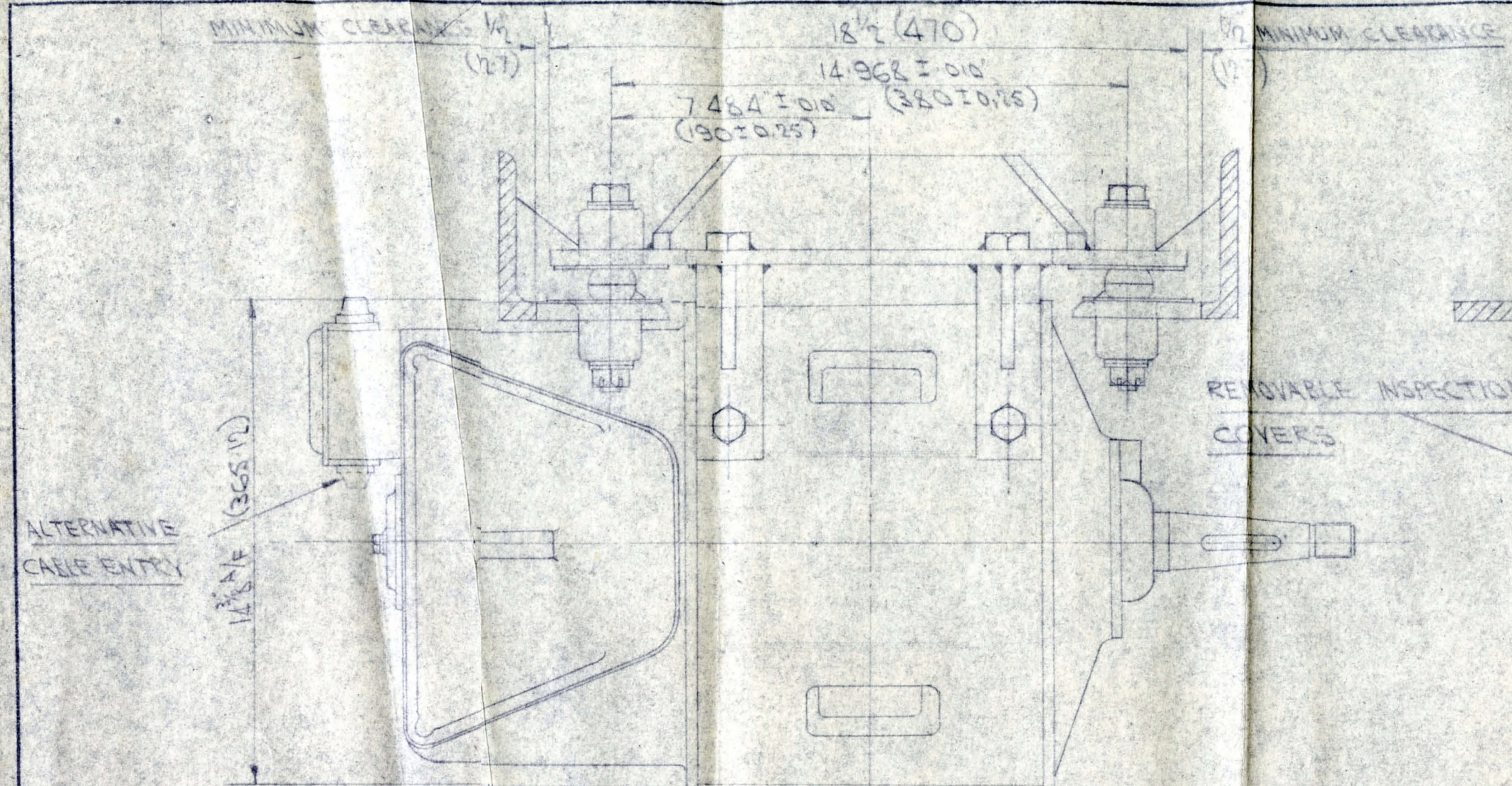

SCRAP VIEW SHOWING DRILLING OF CUSTOMER'S BRACKET.

OUTLINE OF ANTI-VIBRATION MOUNTED

WEIGHT OF MACHINE 460 LBS 207 KILOS.
MILLIMETRE DIMENSIONS IN BRACKETS
SCALE 3" = 1 FOOT

