

De danske Statsbaner
Maskinafdelingen.

Fortegnelse

over

Strømskemaer og Diagrammer

til Vogne

Tilhører

Maskindepotet
Aalborg

Centralværkstedet, København.

do Aarhus.

2. Distrikt.

Maskinafdelingens Tegnestue.

do. ved Centr.-vk., Kh.

Revideret:

Maskinafdelingens Tegnestue
ved
Centralværkstedet, København.
den 19

LD	Dato	Litra	Vognnummer	1.
4		Eco.	6206, 6211, 6226, 6231, 6234, 6238, 6242, 6245, 6246, 6256, 6283, 6284, 6288, 6293, 6297, 6299, 6300, 6302, 6310.	
4		EH.	6600, 6762, 6777, 6793.	
4A		Eco. EH.	Anv. i ovennævnte vogne, hvis regulering har rød klap.	
28A		Eco.	6280 m. rød klap. Uden rød klap har vognen LD28 ^{rev} 29-11-66	
35	28-12-43	CP.	2865	
53		CP.	3258	
57		CRS.	3602, 3678	
58		ARM.	149	
82	25-10-63	De.	92-68007/012.	
85	4-7-53	CP.	2802, 2820, 2852, 2859, 2878, 2913, 3207.	
89	20-2-57	Cl.	29-25 501/612	
90	17-11-66	Bqoh.	29-64 209/210	
97	20-11-66	Cle.	82-25685/699	
104		CP.	2801, 03, 06, 14, 15, 28, 29, 31-36, 39, 44, 45, 46, 48, 51, 53-55, 58, 64, 67, 70, 71, 72, 75, 76, 84, 86, 88, 89, 91, 99, 2901, 05, 06, 11, 12, 17, 18, 20, 21, 22, 27, 29, 30 3202, 03, 05, 06, 08-14, 16-23, 25-27	
104		CPS	3228, 29, 35, 39.	
104		CP	3230-34, 36, 38, 40, 41, 42, 44, 45, 47, 48, 49, 50, 51, 53, 54, 55, 57, 3301.	
108	27-5-57	Bq	29-63180, 183 185/189 NB! Før modernisering.	
112	25-10-68	ABh	38-21257/258 38-21260.	
119	15-1-62	CMR	2119 og 2121.	
121	25-10-68	ABV	38-51336, 337 -339, 340 Vogne m. El.-varme.	
123	29-6-69	Pa	90-28008/012 Vogne m. Reg 55 dynamo.	

LD	Dato	Litra	Vognnummer
			2.
123	22-6-69	Pa	90-28 013/017.
"	"	Da	92-28 100/106.
123	29-6-69	DH	5302.
123	23-9-67	DH	5316
126	25-10-68	AL	17-61-341/350. (Før modernisering)
128	2-12-67	Cl.	29-26476/500. 29-26632/638. Bhl 29-25400/404
128	2-12-67	Cl	29-25613/631. Vogne m. Reg. KR. 150.
128	2-12-68	Cl	29-25613/631 Vogne m. Reg. ZR 50s.
128	2-12-67	ClS	29-27701/718 Vogne m. Reg. KR. 150.
128	2-12-68	ClS	29-27701/718 Vogne m. Reg. ZR 50s.
129	7-5-69	Cle	82-25678/684.
131		Bg	29-63089/098 (Jnden modernisering.)
132		Bg	29-52181/182 og 184 " "
133	10-7-67	DP	91-28139/150.
134		EH.	6866, 6872
142	25-10-68	ABV	38-51321/326, 328 og 330 (Jnden moderniser.)
143	8-5-69	PK	5901-5921
144	28-10-68	Ah	17-21011/013, 014, 016, 017, 025, 031, 033, 034, 035 og 036. 17-61041
144	25-10-68	Ah	17-21012/015, 028, 029, 071, 072.
145	20-1-68	Bf	27-65/321-340 (Jnden modernisering)
149	18-9-63	Bg	29-63/049-088
151	6-1-65	Pb	90-29/106-110
151	6-1-65	Pf	90-68/201-221 (Vogne m. Stone anlæg).
153	19-2-66	BRh	85-24/281-290
154	24-10-68	ABV	38-61/241-252 (Jnden modernisering).
154	24-10-68	ABV	38-61/253-255 " "

LD	Dato	Litra	Vognnummer	3
154	24-10-68	ABv	38-61293/312 (Inden modernisering)	
154	24-10-68	ABv	38-61327, 329, 332, 333, 334, 335, 338 " "	uden El-varme
155	25-10-68	ABhl	38-21261/262, 265-270	
155	25-10-68	ABh	38-61273/274, 276-280 og 284	
156	16-11-67	BDh	82-24264/271 og 275-276.	
157	23-10-68	ABxh	38-21391/394, 38-21396/397	
158	20-4-68	Pa	90-28001/007 og 008-012	når disse sidste vogne har fået 100A. dynamo.
160		Pm	90-68701/705	
161	5-5-69	Cle	82-25670/677	
162	10-11-66	De	92-68001/006	
163		Eco	6212, 6235, 6239, 6254, 6259, 6265, 6267, 6280, 6281, 6285, 6286, 6291, 6295, 6304, 6308.	
164	26-9-67	De	92-68013/032	
165	16-12-65	Bu	89-25700/701	
166	5-2-69	B	20-84000/144	
166	17-3-69	B	20-84000/144 (Vogne m. nye sæder og støvsugerkont.)	
167	3-3-69	B	20-80300/319	
168	16-11-67	Ae	17-61185, 187, 189	
169	16-11-67	ABy	38-61186, 188, 190	
171		Bqoh	29-64208 NB! LD 170 se nederst side 4.	
172	29-10-68	Ah	17-21019, 021-024, 040 og 042	
172	29-10-68	ABhl	38-21264, 271, 272	
172	29-10-68	ABh	38-61275, 281, 282, 285, 287-292	
172-1	9-11-68	Ah	17-21018, 020, 026, 027, 030, 032	
172-1	9-11-68	Ah	17-61037/039, 043-052	
173		Bu	89-25702/704.	
175		Bqh	29-63109/144	

LD	Dato	Litra	Vognnummer
175		Bghl	29-63 145/148.
175		Bjh	29-24 301/308
176	24-2-69	A	18-84 000/014
177	11-7-69	Bqoh	29-64 201/207, 211/212 og efter ombg 208/210
178	3-2-68	Pb	90-28 101/105
179	23-10-68	ABxh	38-21395 og 38-21398.
180		Bhs	29-27820/29
181	17-7-69	ABhl	38-21263,
181	17-7-69	ABv	38-61286, ABh 38-61283.
182	8-1-69	Pm	90-68 706/713
183		Bg	29-63 149/156, 158/168, 170/178, 180, 183, 185/199.
184		BD	82-84000/019
185		P	90-84800/814
186		AB	39-80000/019
187		Pf	90-68201/221 (Efter ombg. m. Kruppanlæg).
188		Bf	27-65 321/340 (" " Thyristeranlæg).
189		Bg	29-52 181/182, 29-52 184. (Efter ombygning)
190		AK	17-61 341/350 (" ")
191-I		Bgc	29-64 000/002
191-II		Bgc	29-64 000/002
192		ABv	38-61293/312, 38-61 321/340. 38-61241/255.
193		BD	82-80020/029.
194		Bg	29-63 049/098 (Efter ombygning).
NB 170	16-11-67	BDh	82-24 259/263, 272/274, 277/280

Pintsch Dynamo.

Vogn. Ltr. _____ Nr. _____

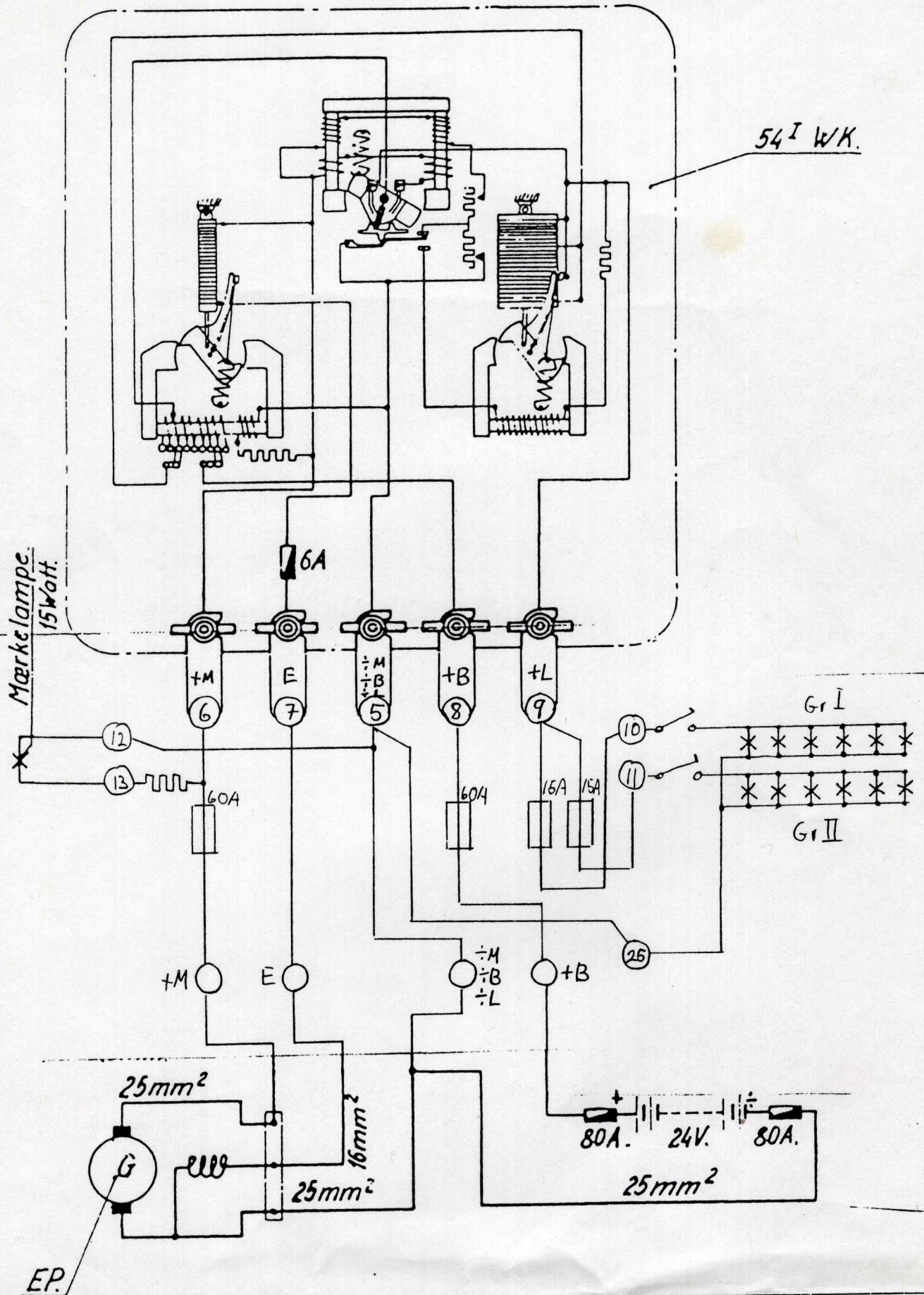

Rosenberg Dynamoanlæg.

Vogn Ltr. DH Nr. 5312, 13, 14, 16, 17

QS.203
E15

Indstilling: 3/4.

Tavle Nr. 1

Hovedafbri.
Siemens Type
P 25/3 III

Mærke
Lampe
24V, 15 Watt

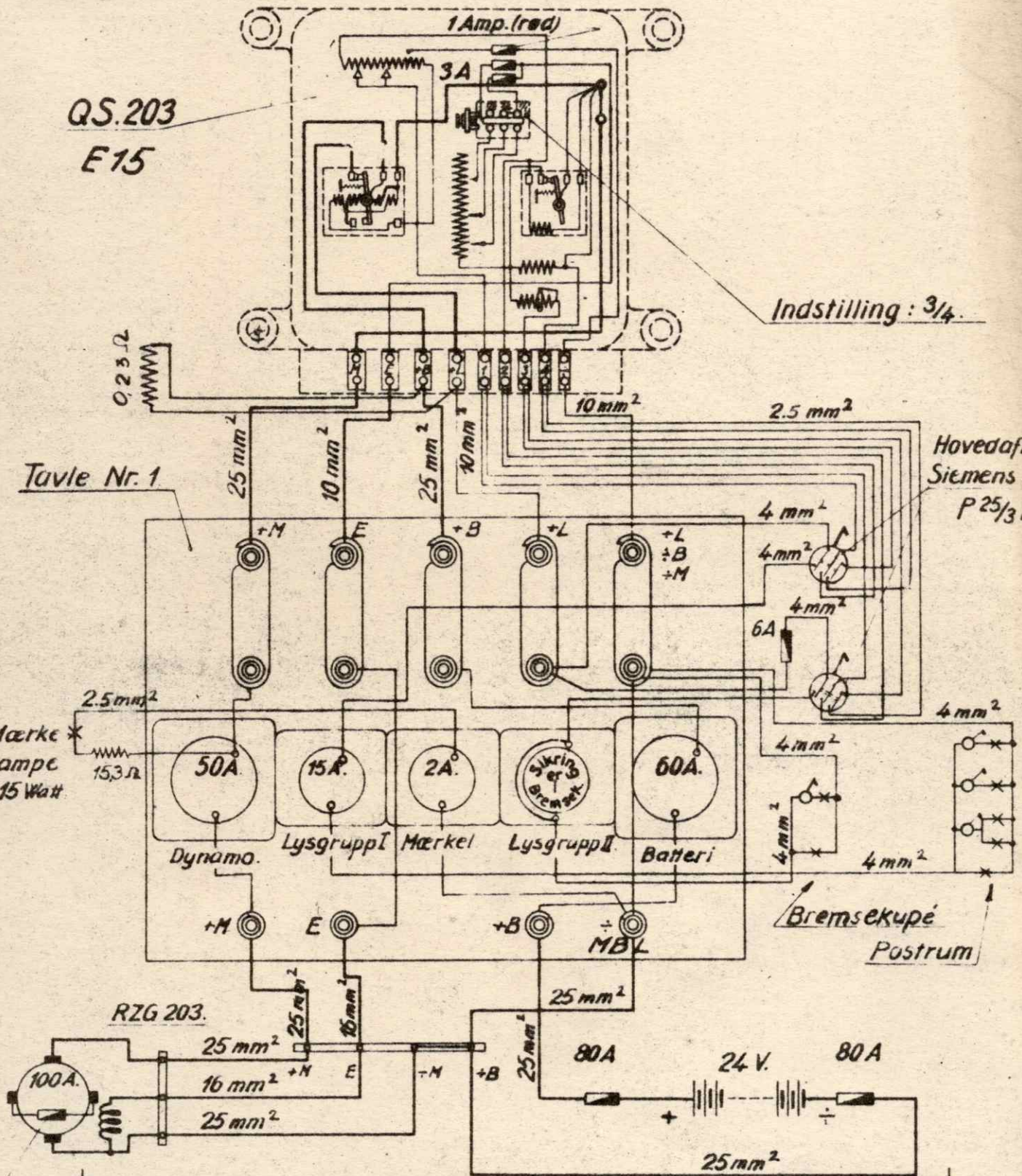

Bremsekupe
Postrum

RZG 203.

K

Chefen for Maskinafdelingen.

LD. Nr. 1.

Rosenberg Dynamo.

Vogn Ltr. D Nr. 5401, 03, 05, 09, 17-20

QS.203.
E.15.

Indstilling: $\frac{3}{4}$.

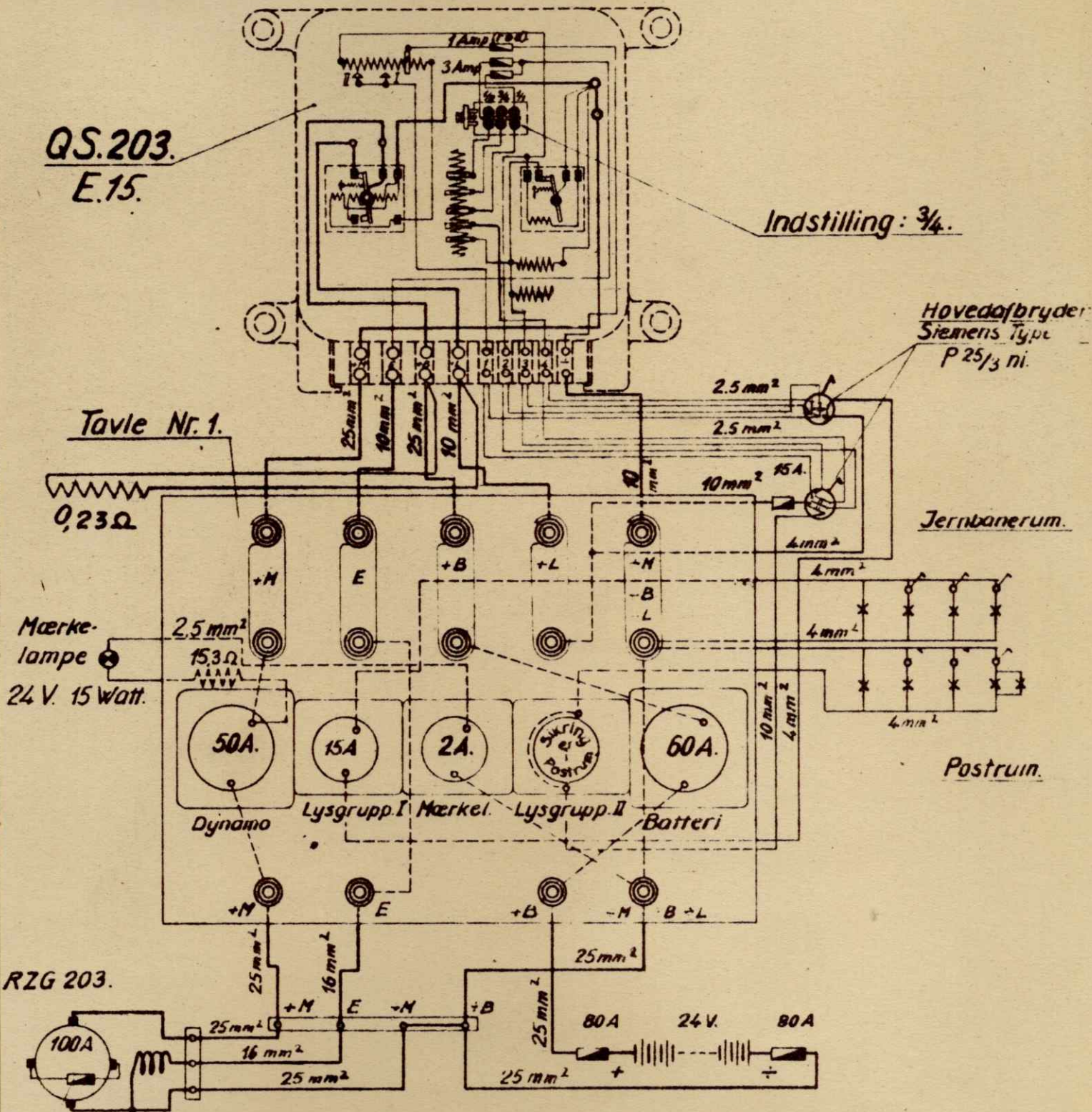

RZG 203.

K

Chefen for Maskinafdelingen.

LD. Nr. 2.

Rosenberg Dynamoanlæg.

Vogn Ltr.

DP 5855-58
DR Nr. 5864-69
ECO - alle
EC - alle
EF : 6534-36
EH - alle
EK - alle

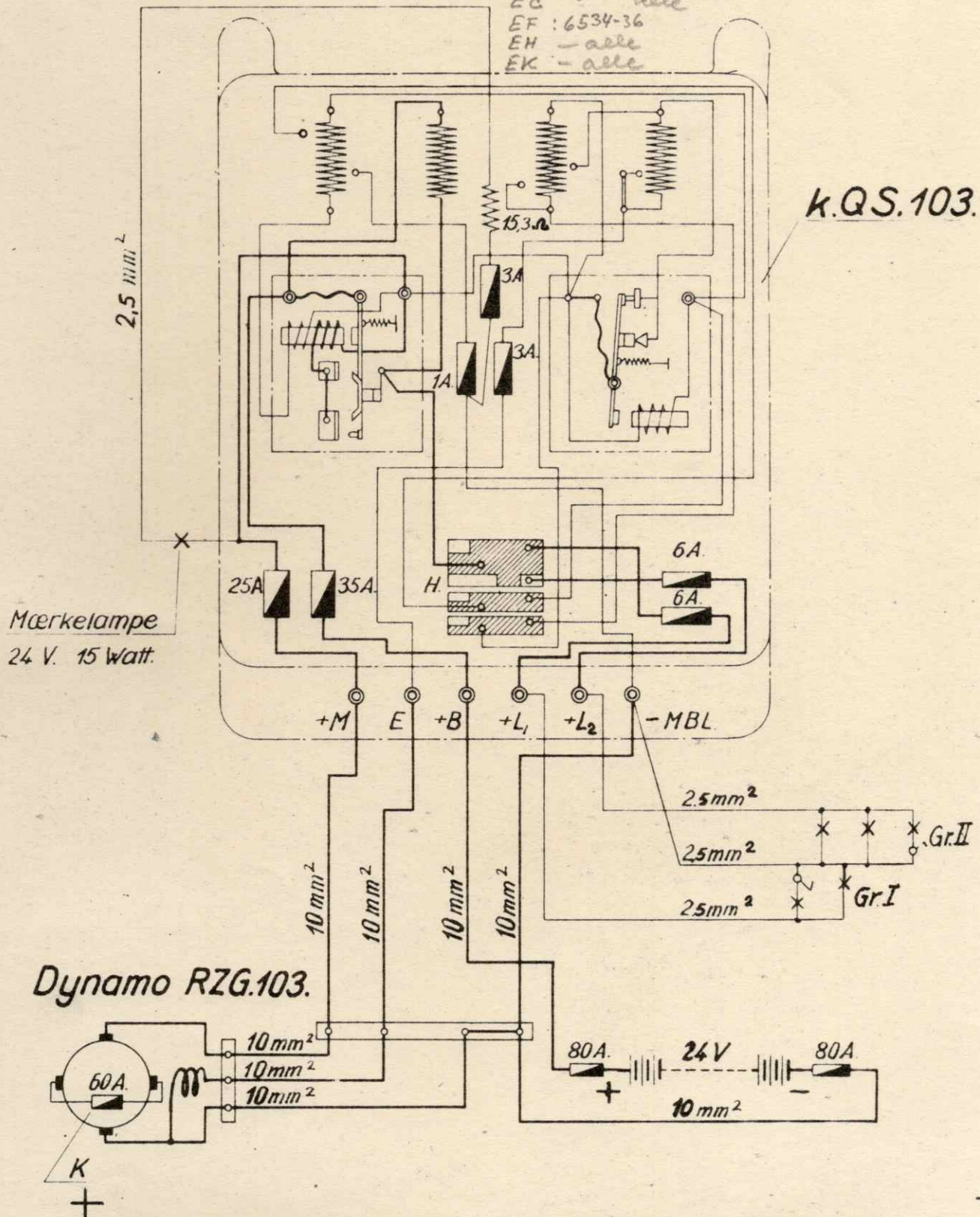

Chefen for Maskinafdelingen.

LD. Nr. 4.

Rosenberg Dynamoanlæg.

Vogn ltr. nr. *Samme som LDY (efter ændring)*

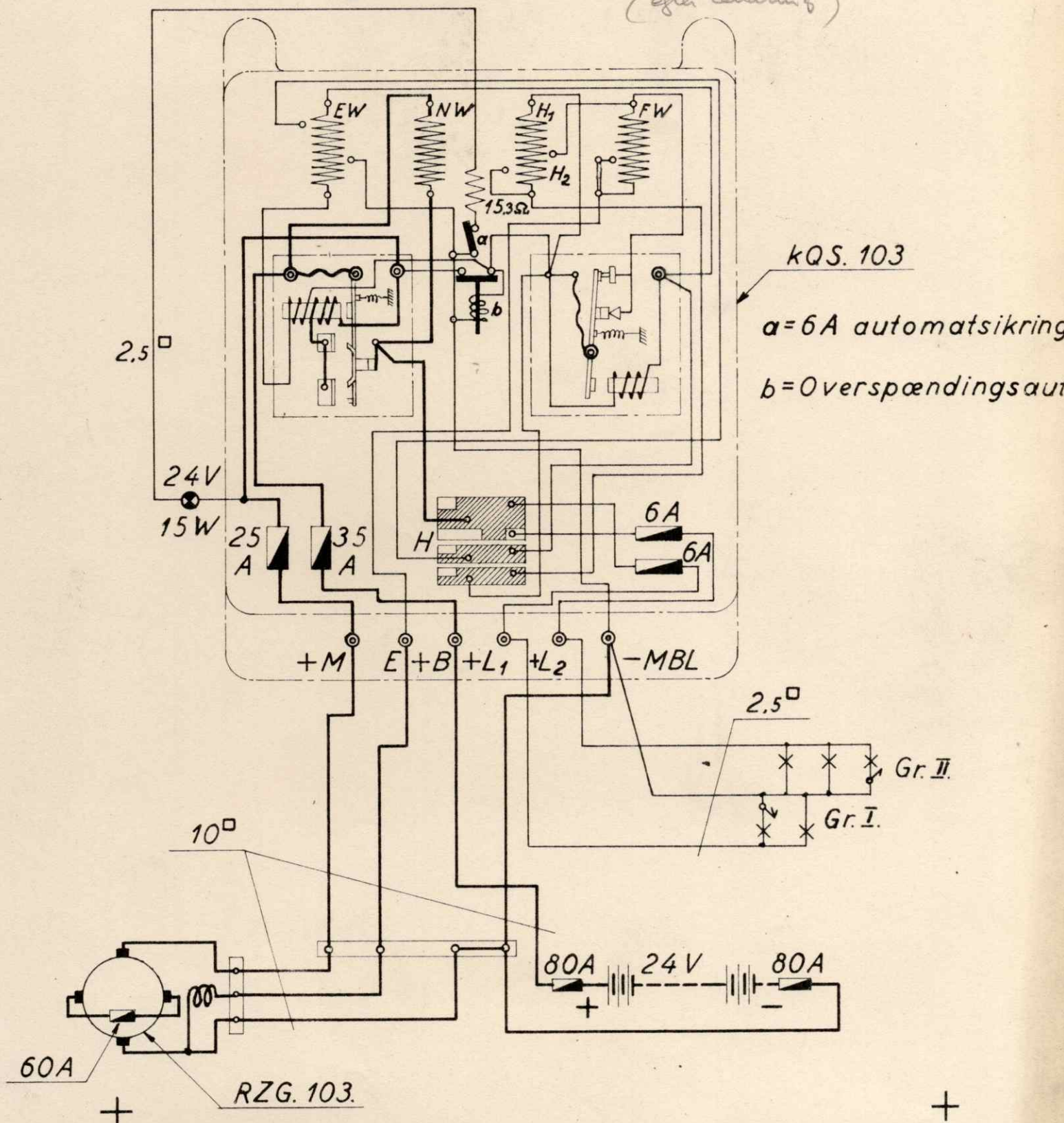

Chefen for Maskinafdelingen.

LD. nr. 4.A.

Pintsch Dynamo.

Vogn Ltr. CPE. Nr. 2984.-87, 89, 91-93

54^I W.K.

Tavle Nr. 2.

Mærkelampe
24V. 15W.

EP.

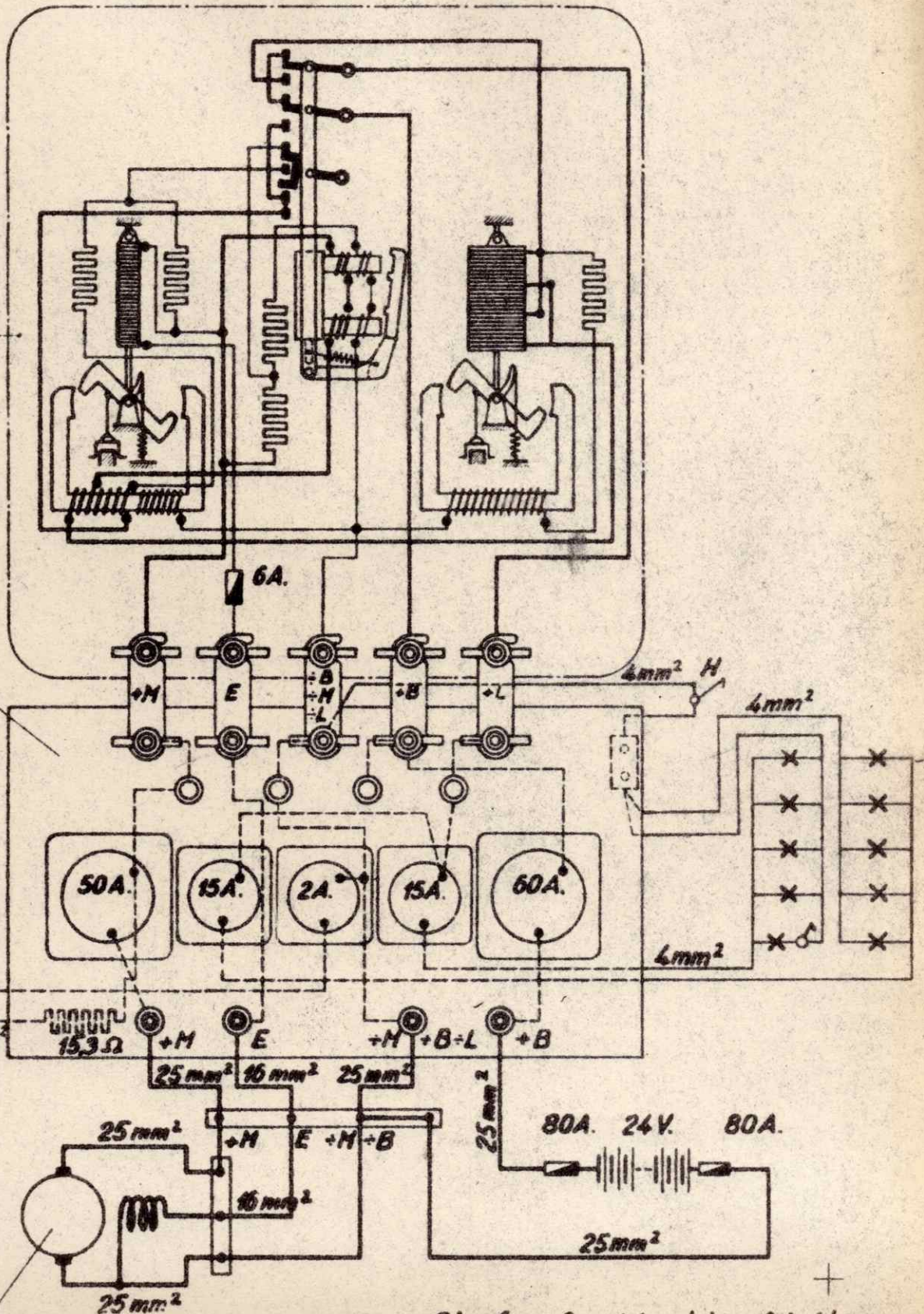

Chefen for Maskinafdelingen

L.D. Nr. 7.

Pintsch Dynamo.

Vogn Ltr. AF Nr. 78-82

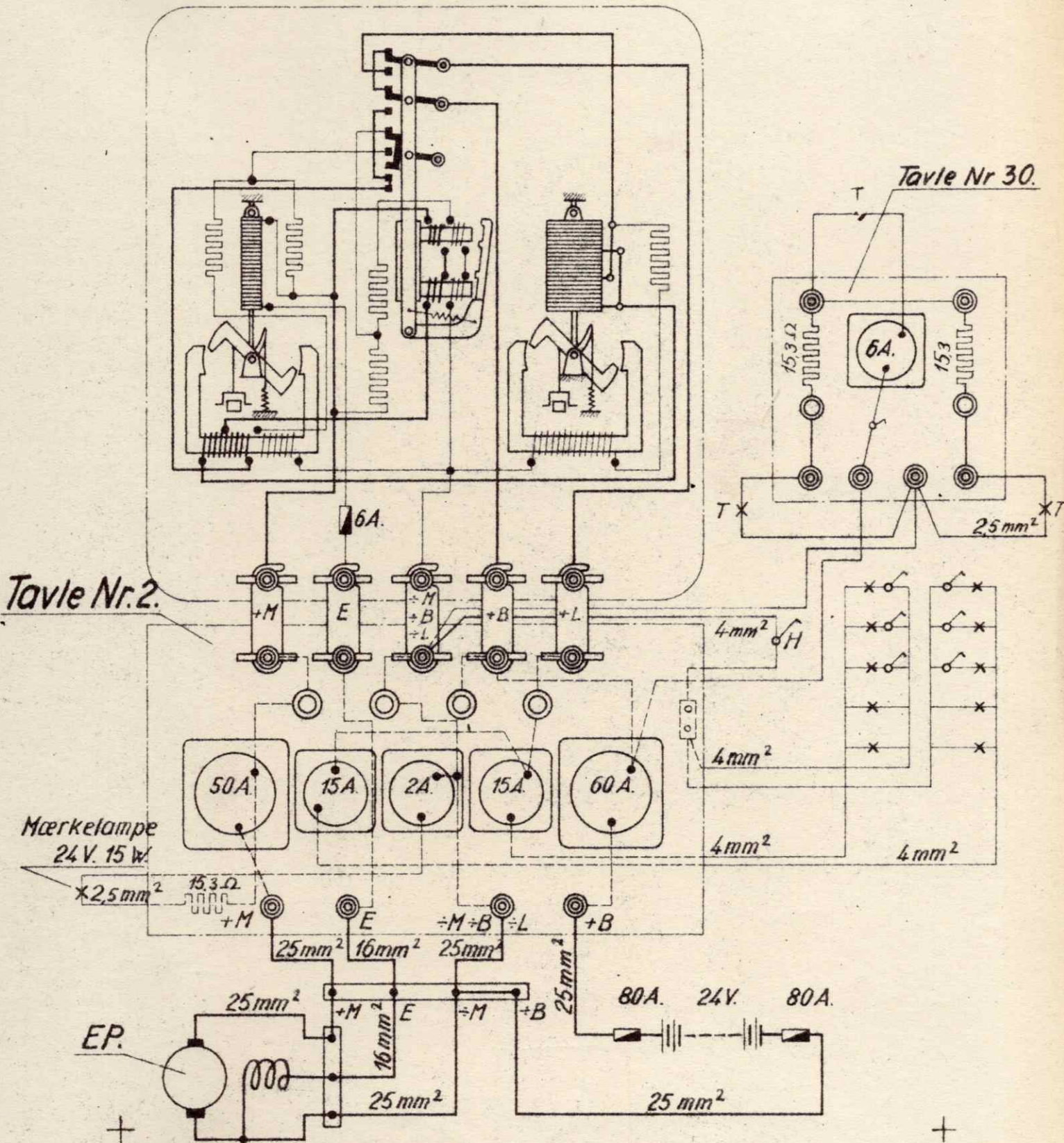

Chefen for Maskinafdelingen.
LD. Nr. 10.

Rosenberg Dynamoanlæg

Vogn Ltr. CRM Nr. 3622, 26, 33, 34, 38-40

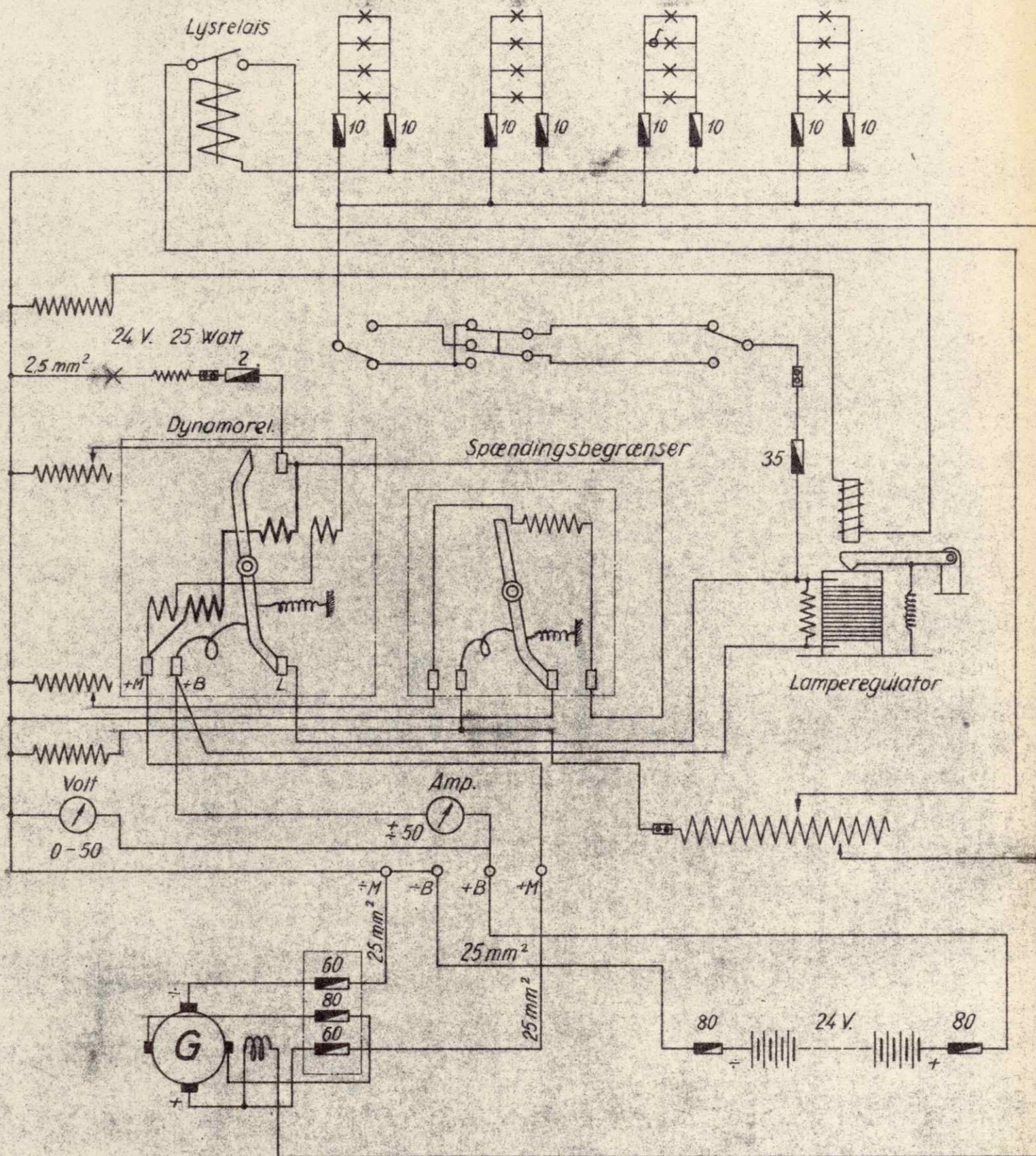

Chefen for Maskinafdelingen.

(LDm12) LD.Nr.11

Pintsch Dynamo.

Vogn Ltr. FT Nr. 208-21

Tavle Nr. 31.

54^IWK.

Tavle Nr. 2.

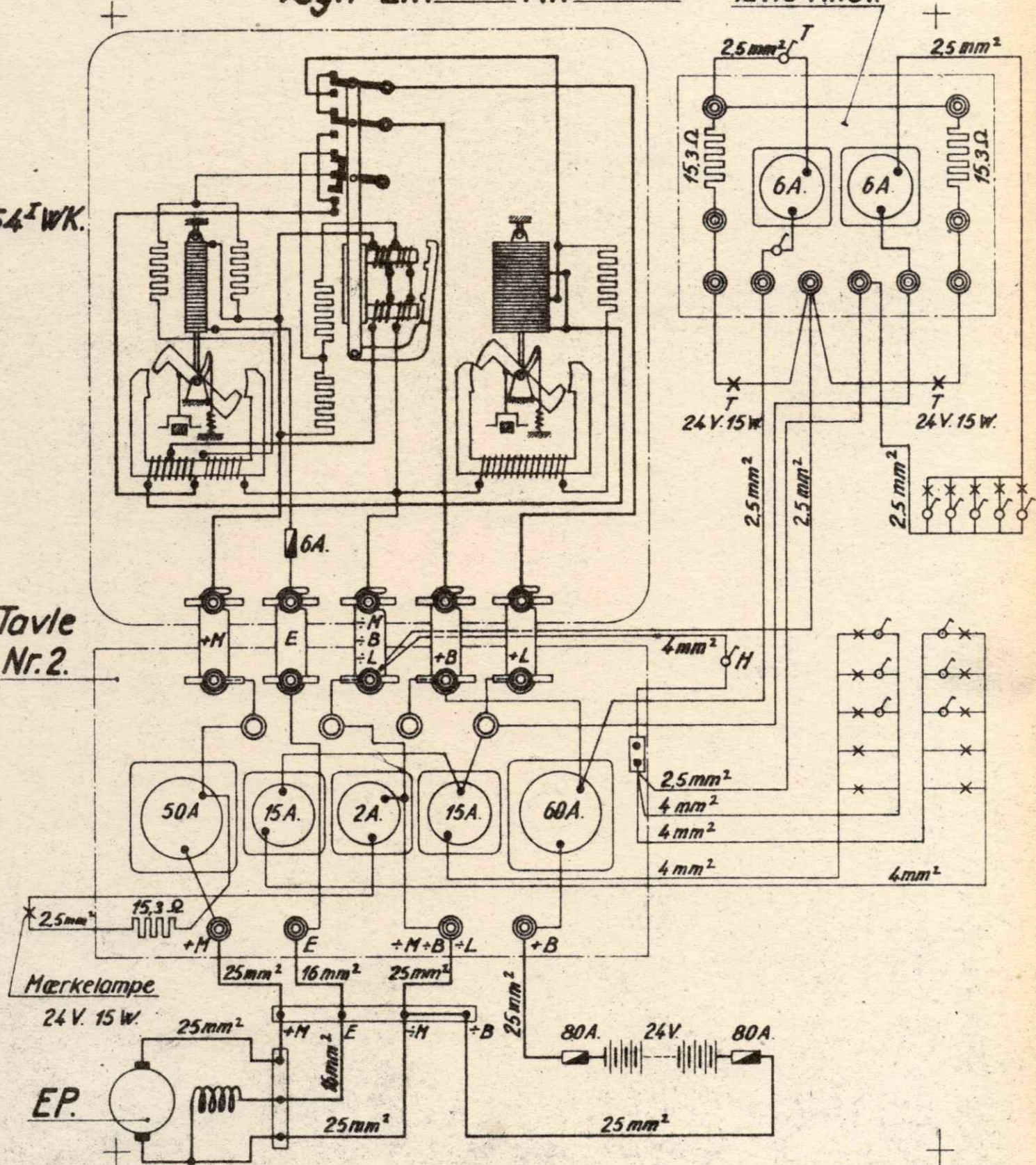

Chefen for Maskinafdelingen.

LD. Nr. 13.

Rosenberg-Dynamoanlæg.

Vogn Ltr. DA Nr. 5013-24

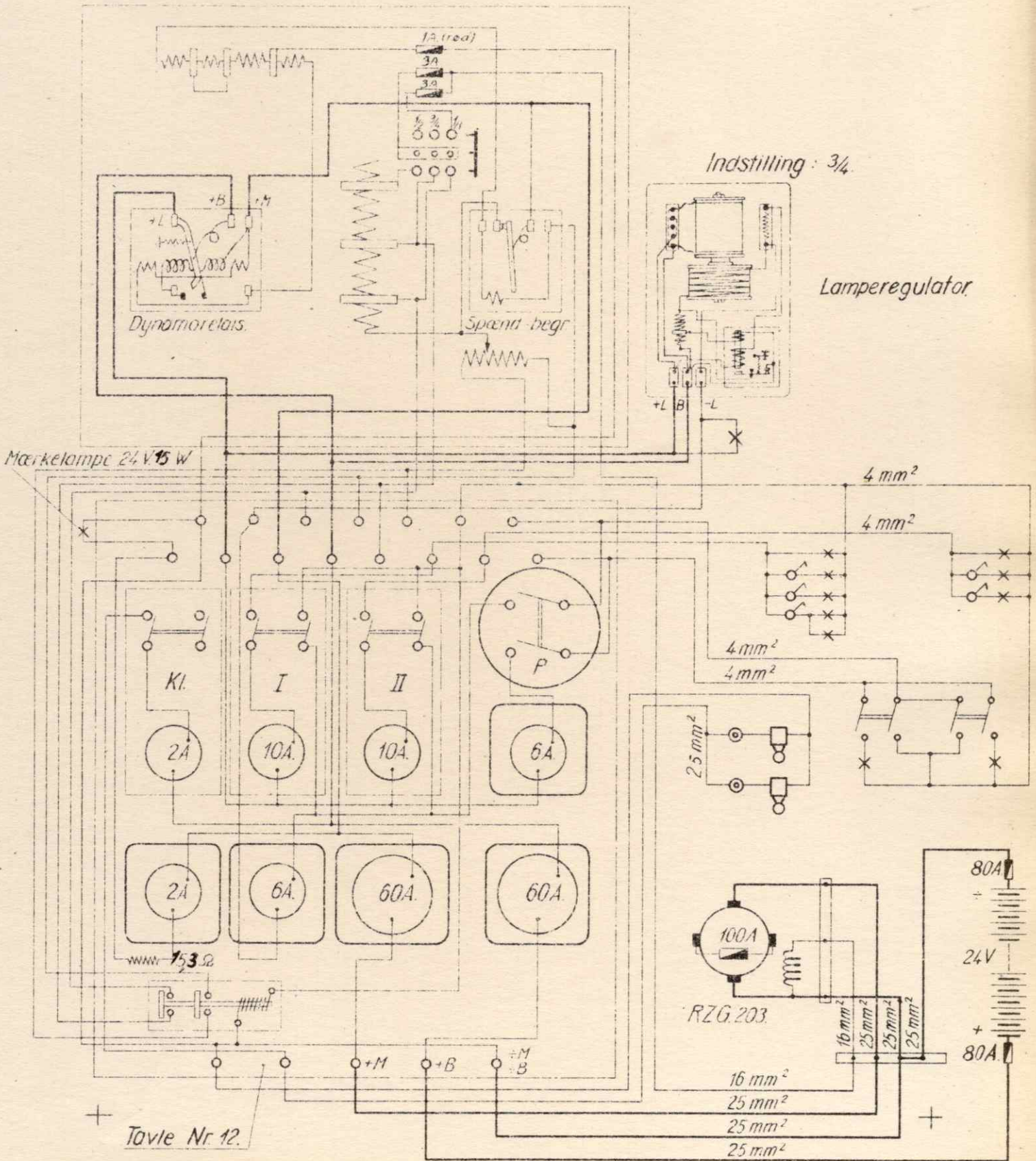

Chefen for Maskinafdelingen. LD. Nr. 14.

Pintsch Dynamo.

Cx 4531-32
Vogn. Ltr. FE Nr. 4911-35 (Vogne nr. tavle 4)

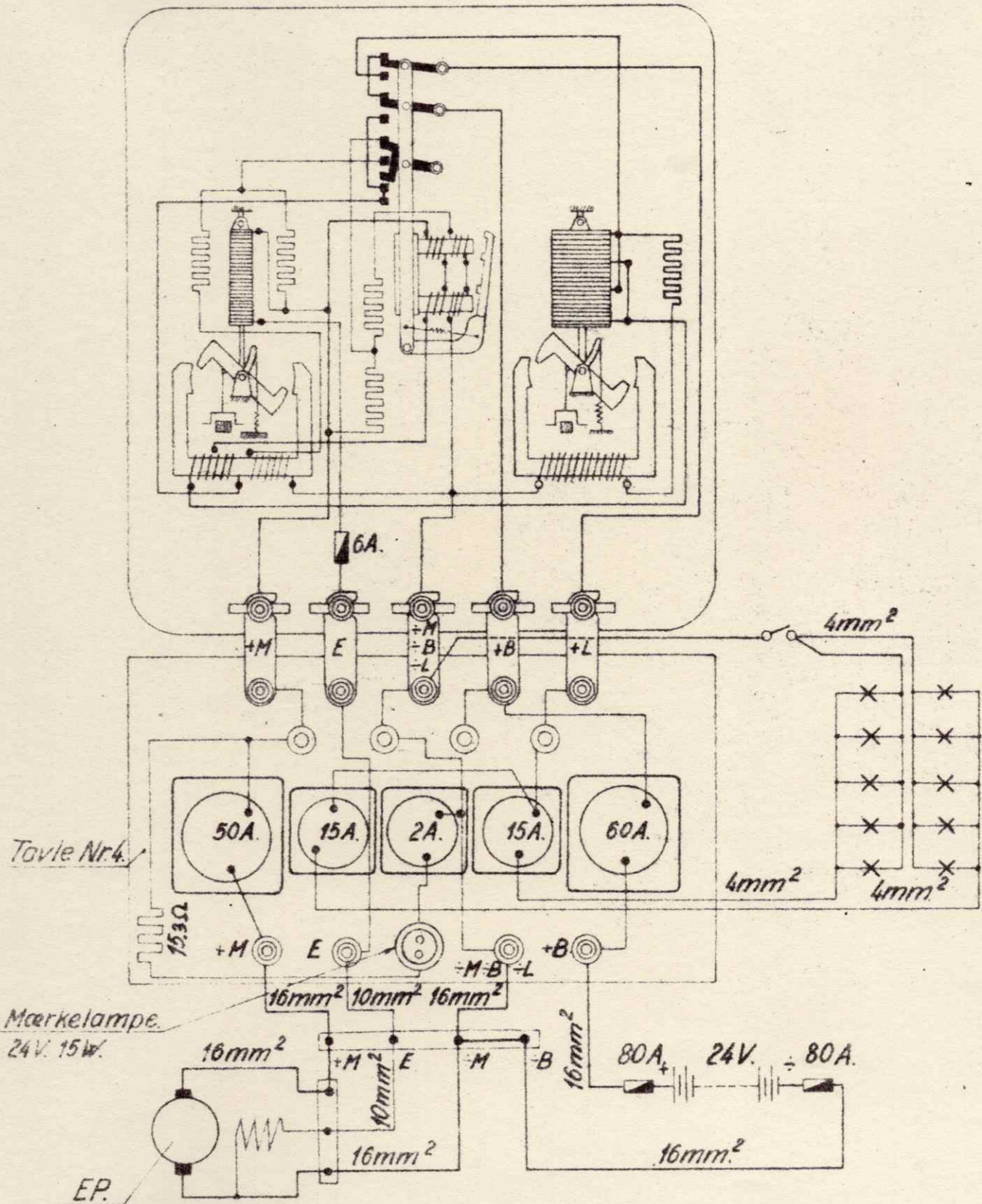

Chefen for Maskinafdelingen.
LD. Nr. 15

Thrige - Dick - Dynamoanlæg.

Vogn Ltr. CB Nr. 1101-08

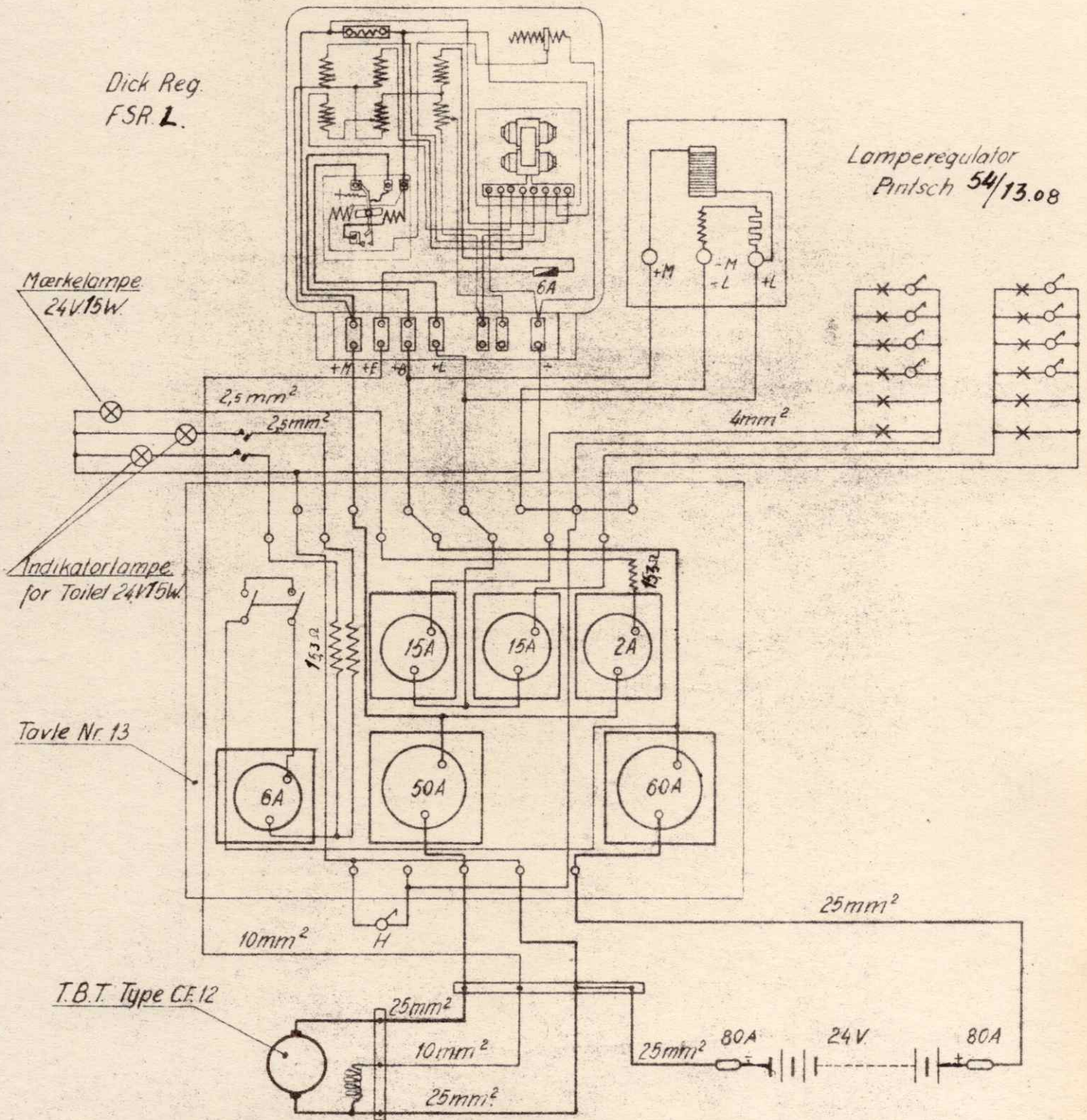

Dick Reg.
FSR. L.

Lamperegulator
Pintsch 54/13.08

Mærkelampe
24V/15W

Andikatorlampe
for Toilet 24V/15W

Tavle Nr. 13

T.B.T. Type CF.12

Chefen for Maskinafdelingen.

L.D. Nr. 16.

Rosenberg-Dynamoanlæg

Vogn Ltr. Co Nr. 2501, 04, 10, 13, 38

Tavle Nr. 14

Tavle Nr. 8

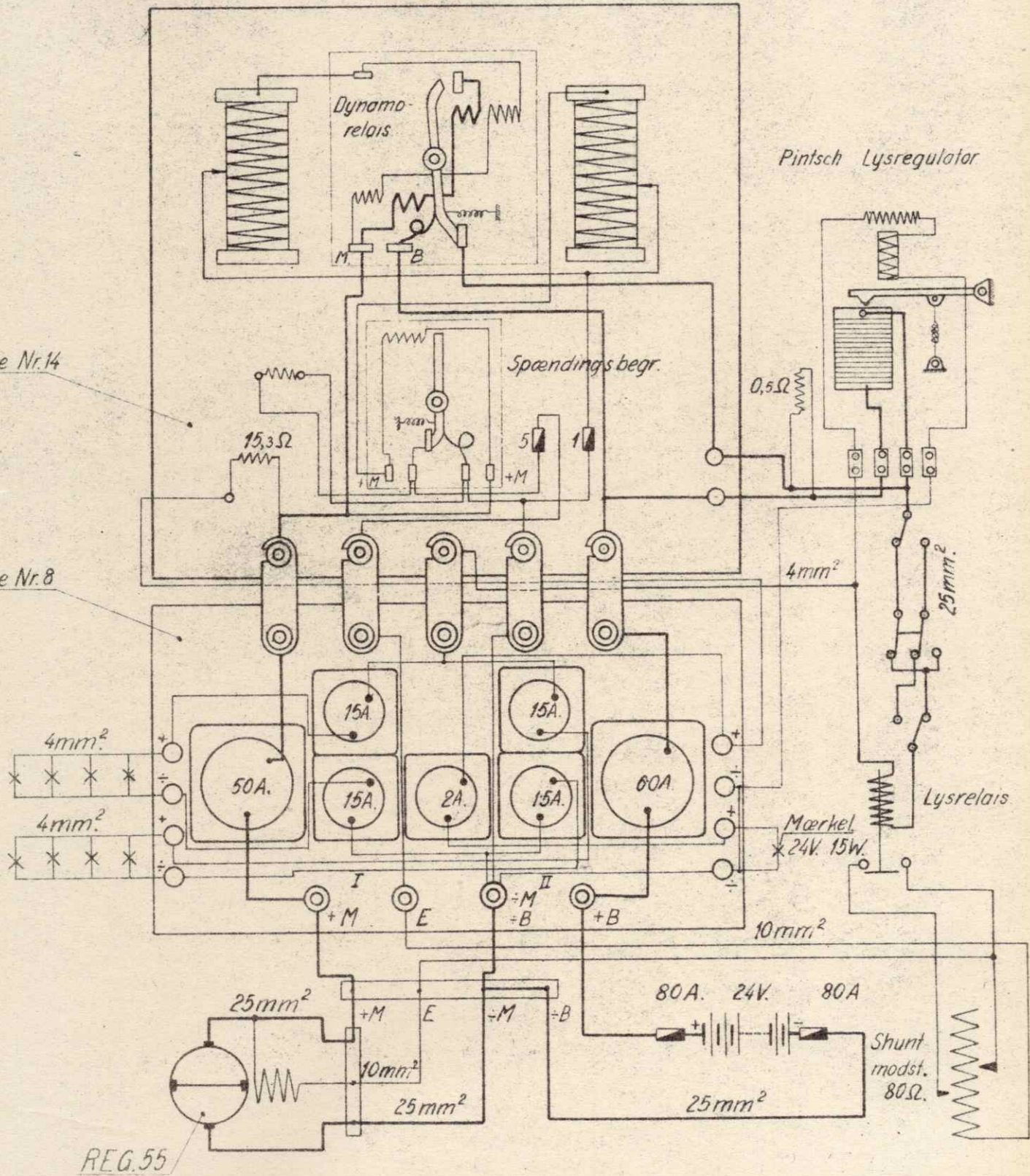

Chefen for Maskinafdelingen.

LD. Nr. 17.

Rosenberg-Dynamoanlæg

Vogn Ltr. Nr.

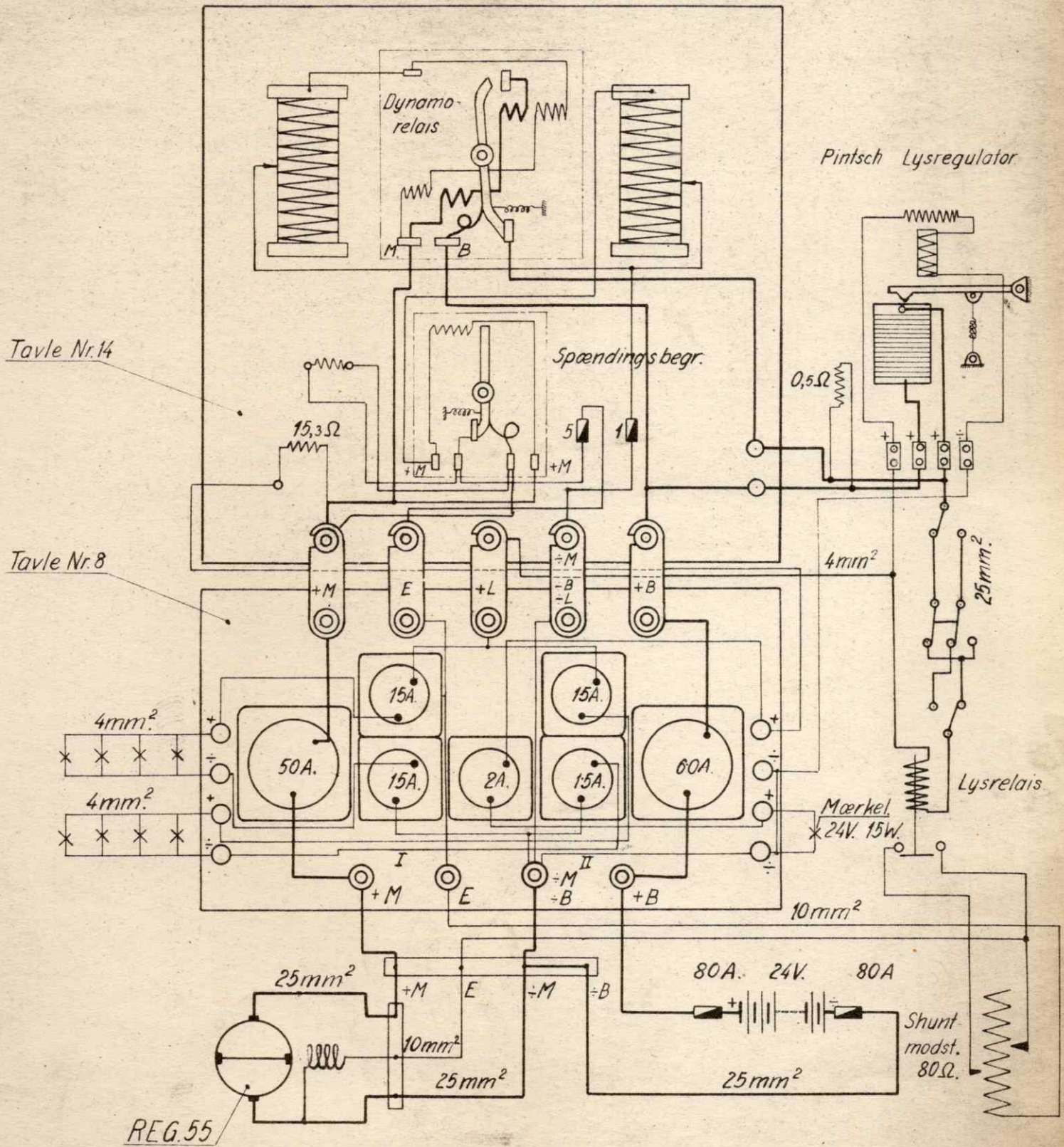

Chefen for Maskinafdelingen.

LD. Nr. 17.

Pintsch Dynamo.

Vogn. Ltr. Cx Nr. 4573, 15-17

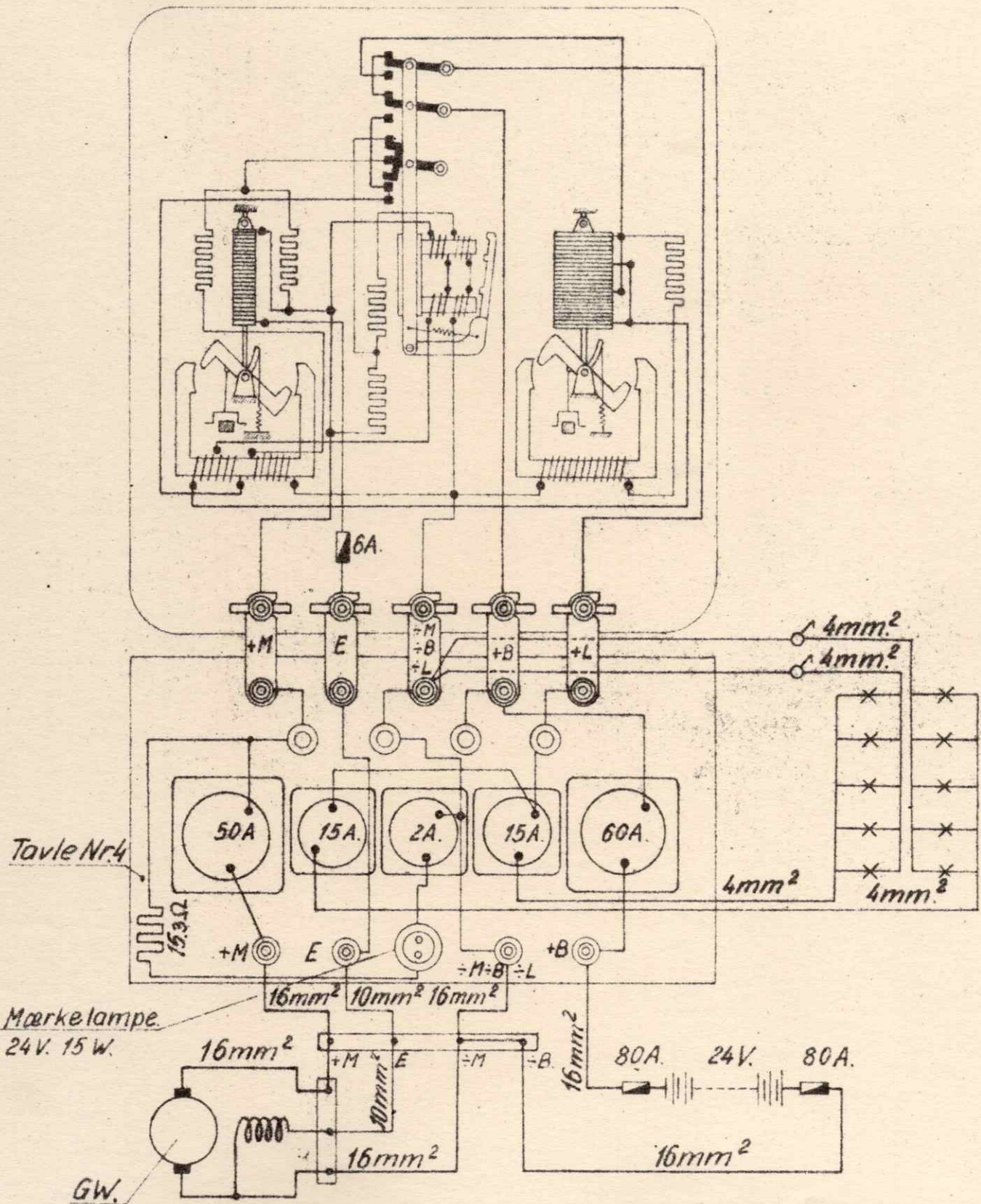

Chefen for Maskinafdelingen.

L.D. Nr. 18.

Rosenberg Dynamoanlæg.

Vogn Ltr. Cule Nr. 4201-03, 19, 21-26

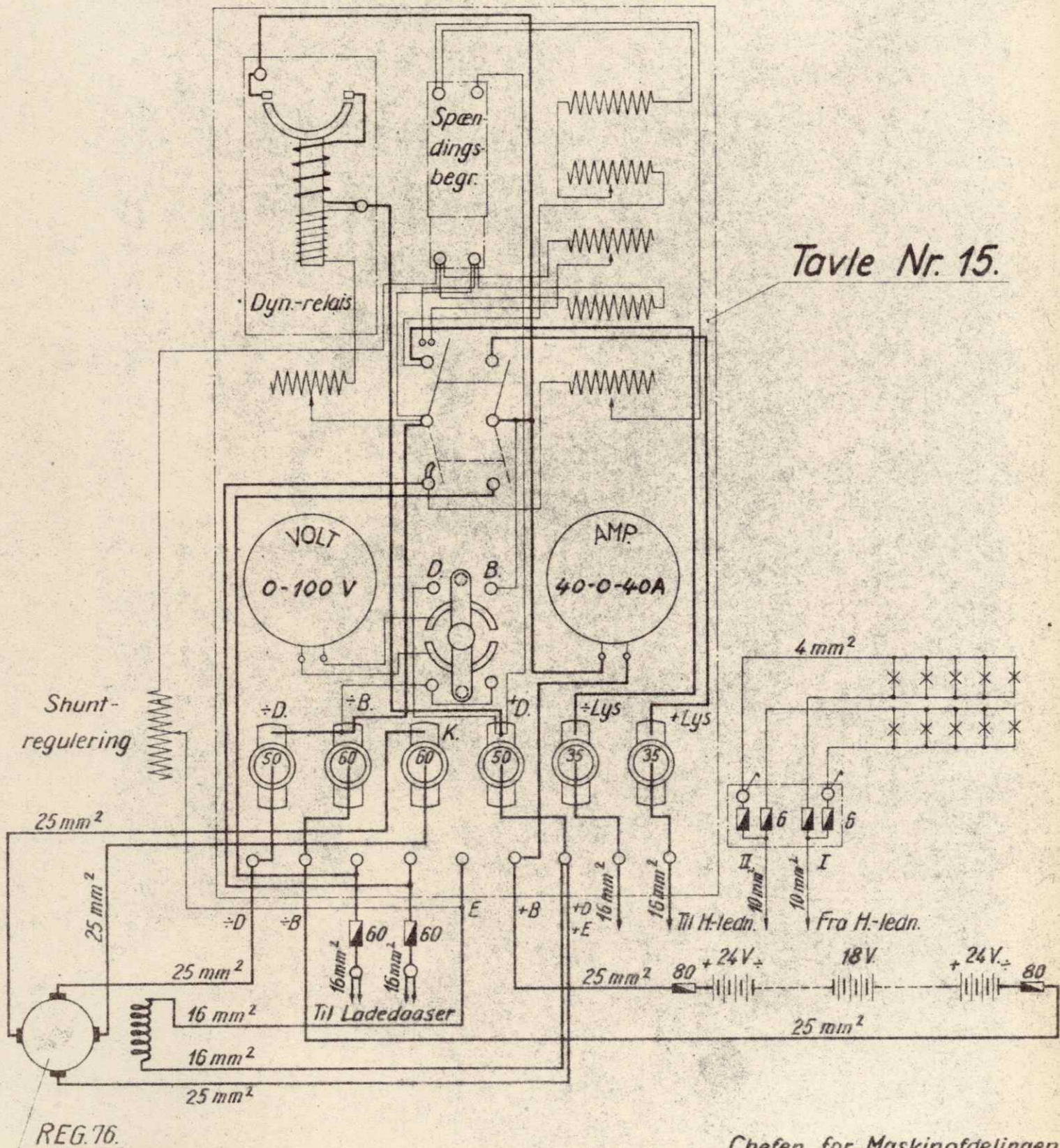

Tavle Nr. 15.

Chefen for Maskinafdelingen.
L.D. Nr. 19.

Rosenberg Dynamoanlæg.

Vogn Ltr. Cuk Nr. 4204-18, 27-52

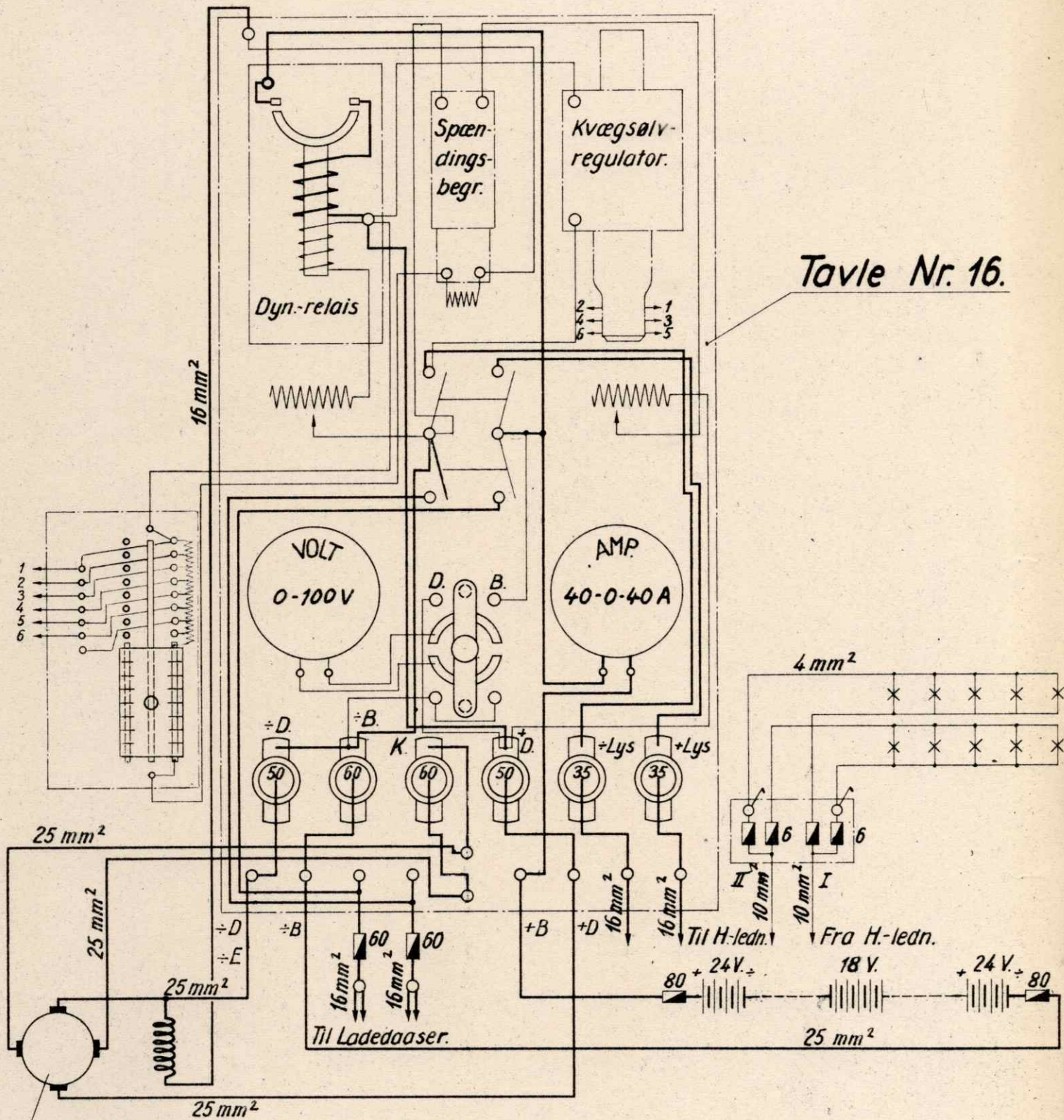

Tavle Nr. 16.

REG 76.

Chefen for Maskinafdelingen.

LD. Nr. 20.

Thrige - Dick - Dynamoanlæg.

Vogn Ltr. Hc Nr. 11-26

Pintsch 54/13.08.

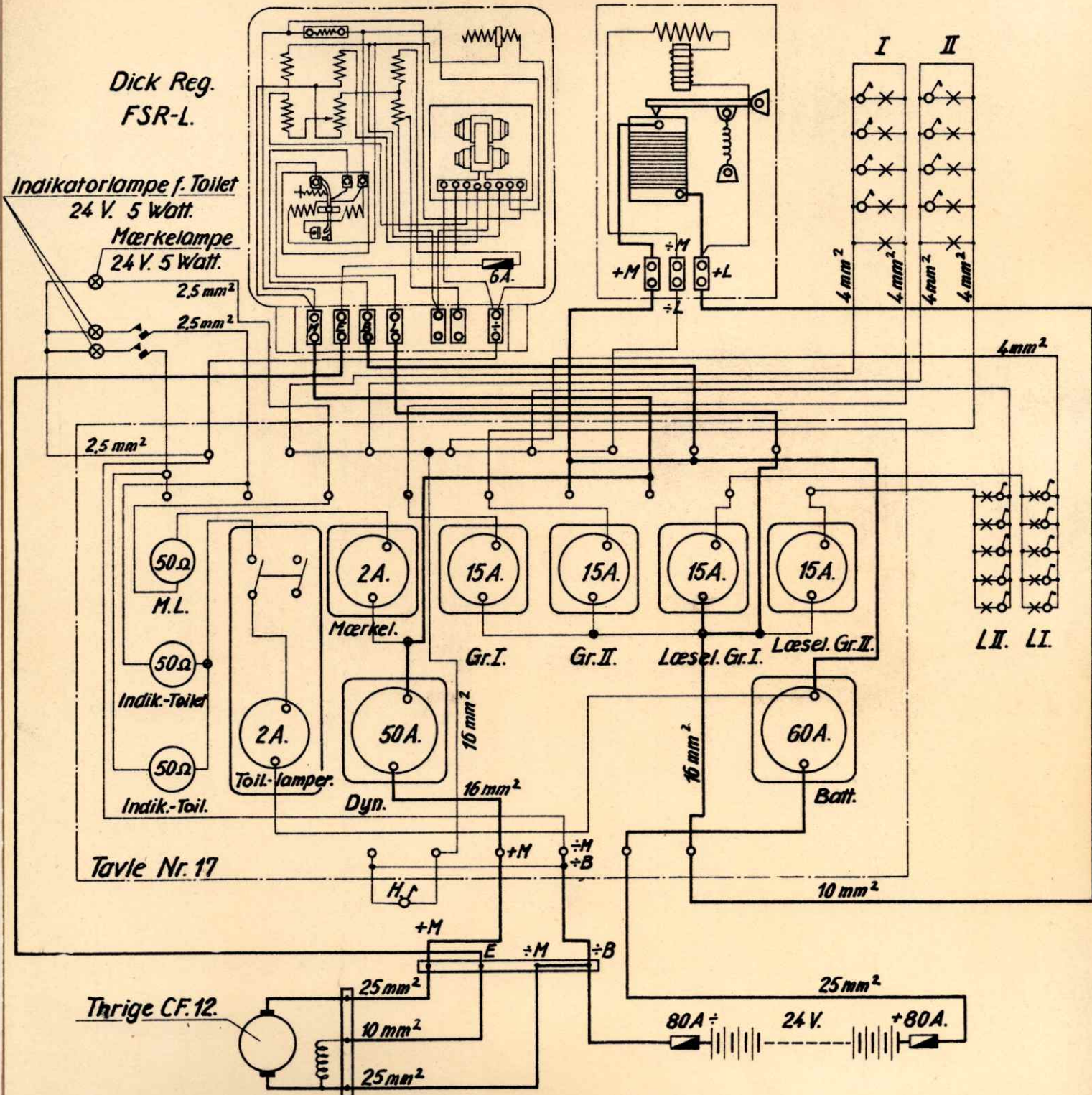

Chefen for Maskinafdelingen.

LD. Nr. 21.

Thrige - Dick Dynamoanlæg.

Vogn Ltr. *Hc* 27-31, 33, 35, 36
Hv Nr. 261-72

Pintsch 54/13.08.

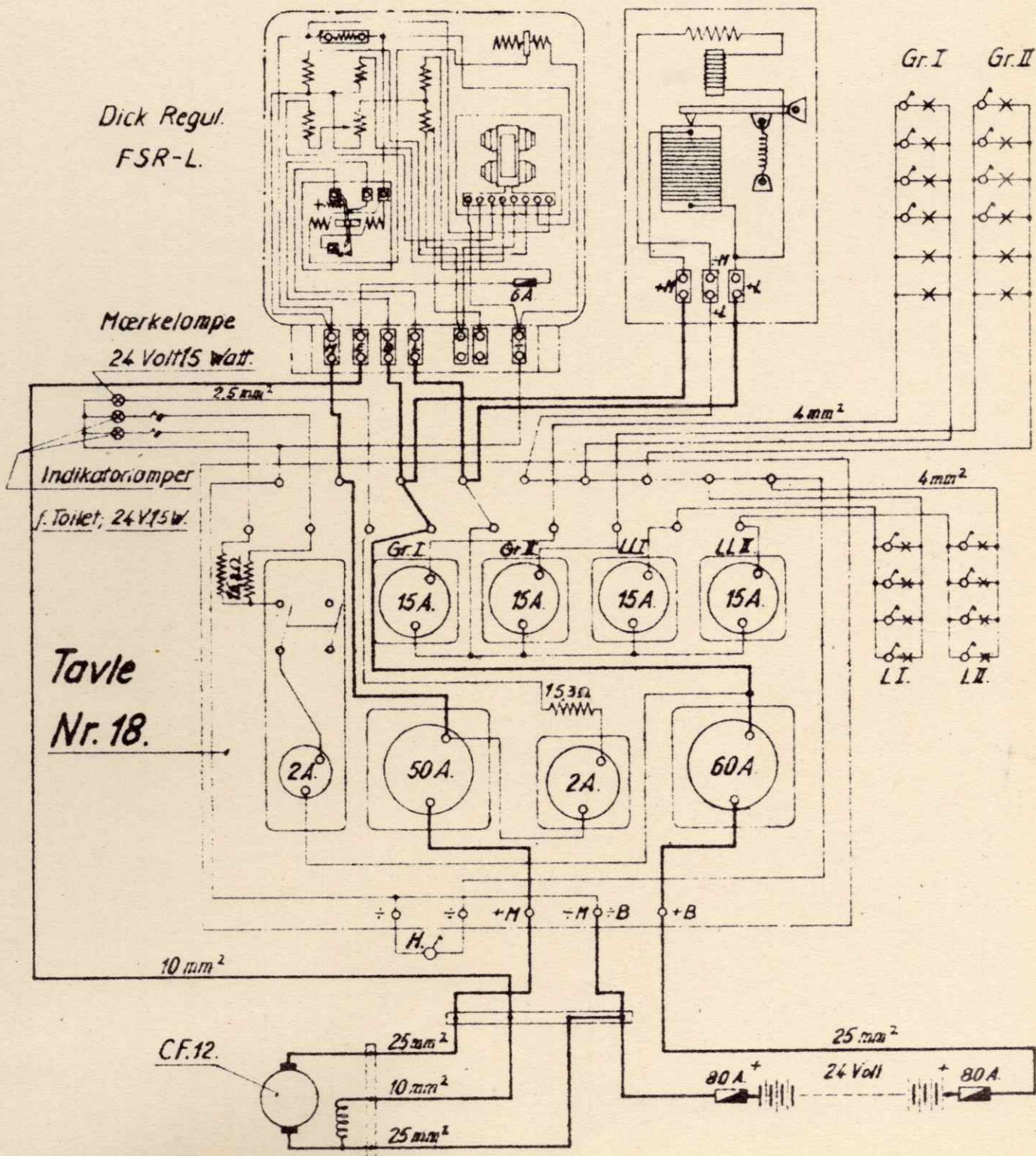

Chefen for Maskinafdelingen.

LD. Nr. 22.

Thrige-Dick Dynamoanlæg.

Vogn Ltr. CF Nr. 1003, 06, 08-10, 12, 14, 16, 18, 23-25

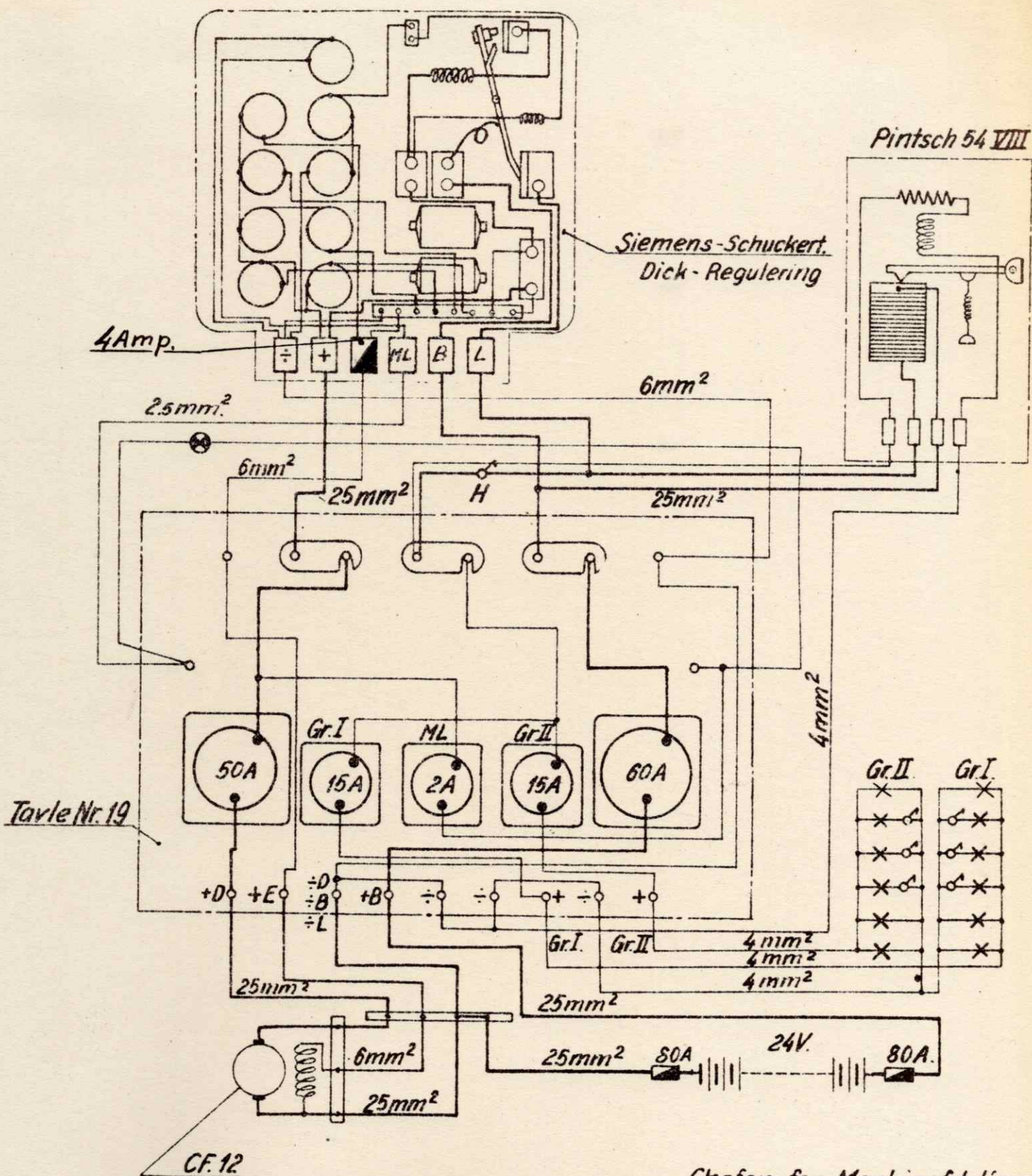

Chefen for Maskinafdelingen.

LD.Nr.24.

Thrige - Dick - Dynamoanlæg.

Vogn Ltr. 7x Nr. 301-08

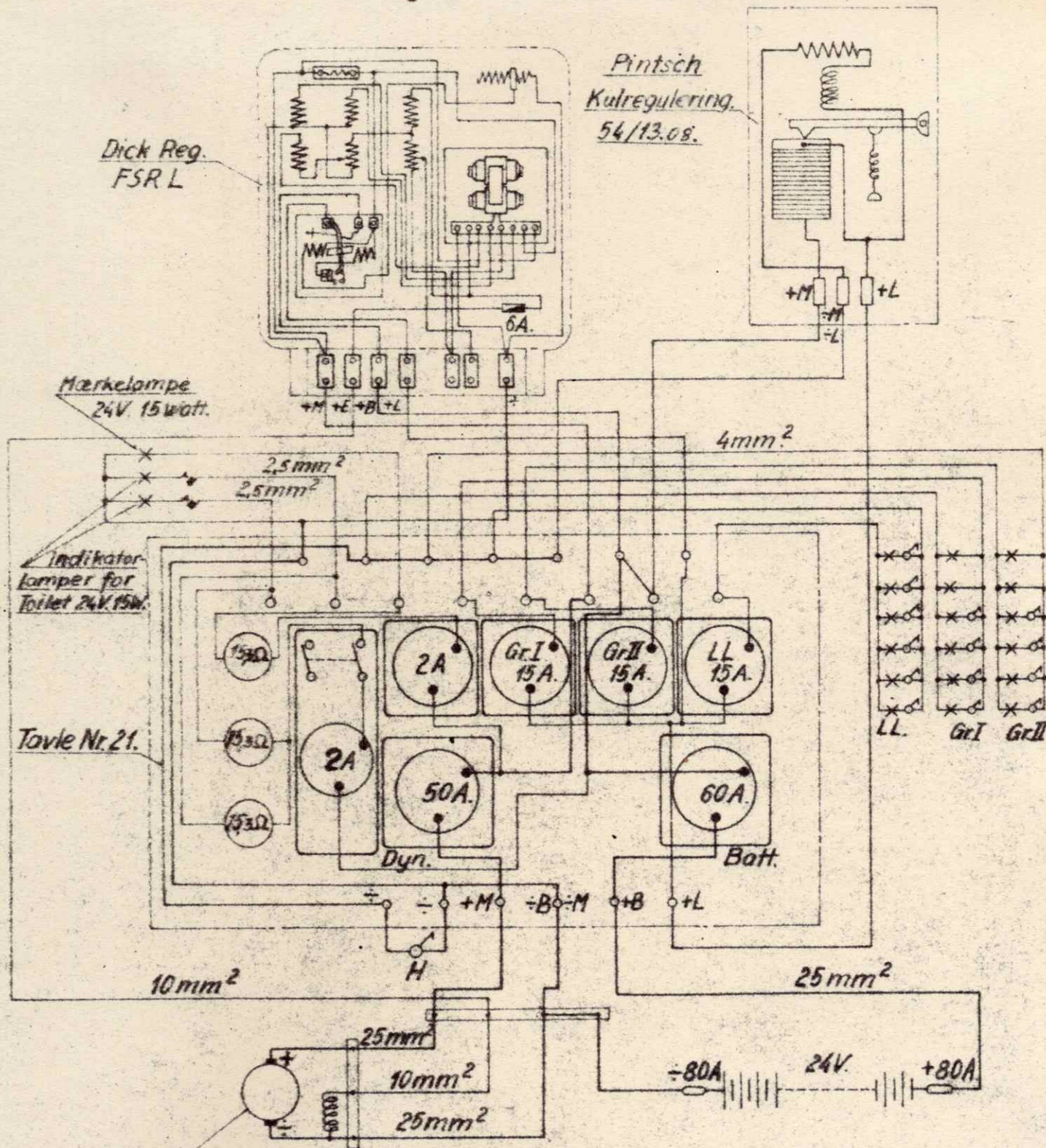

Dick Reg.
FSRL

Pintsch
Kulregulering.
54/13.08.

Mærkelampe
24V 15 watt.

Indikator
lamper for
Toilet 24V 15W.

Tavle Nr. 21.

C.F. 12

Chefen for Maskinafdelingen.

LD. Nr. 25.

Rosenberg Dynamoanlæg.

Vogn Ltr. Ec. Nr. 6280.

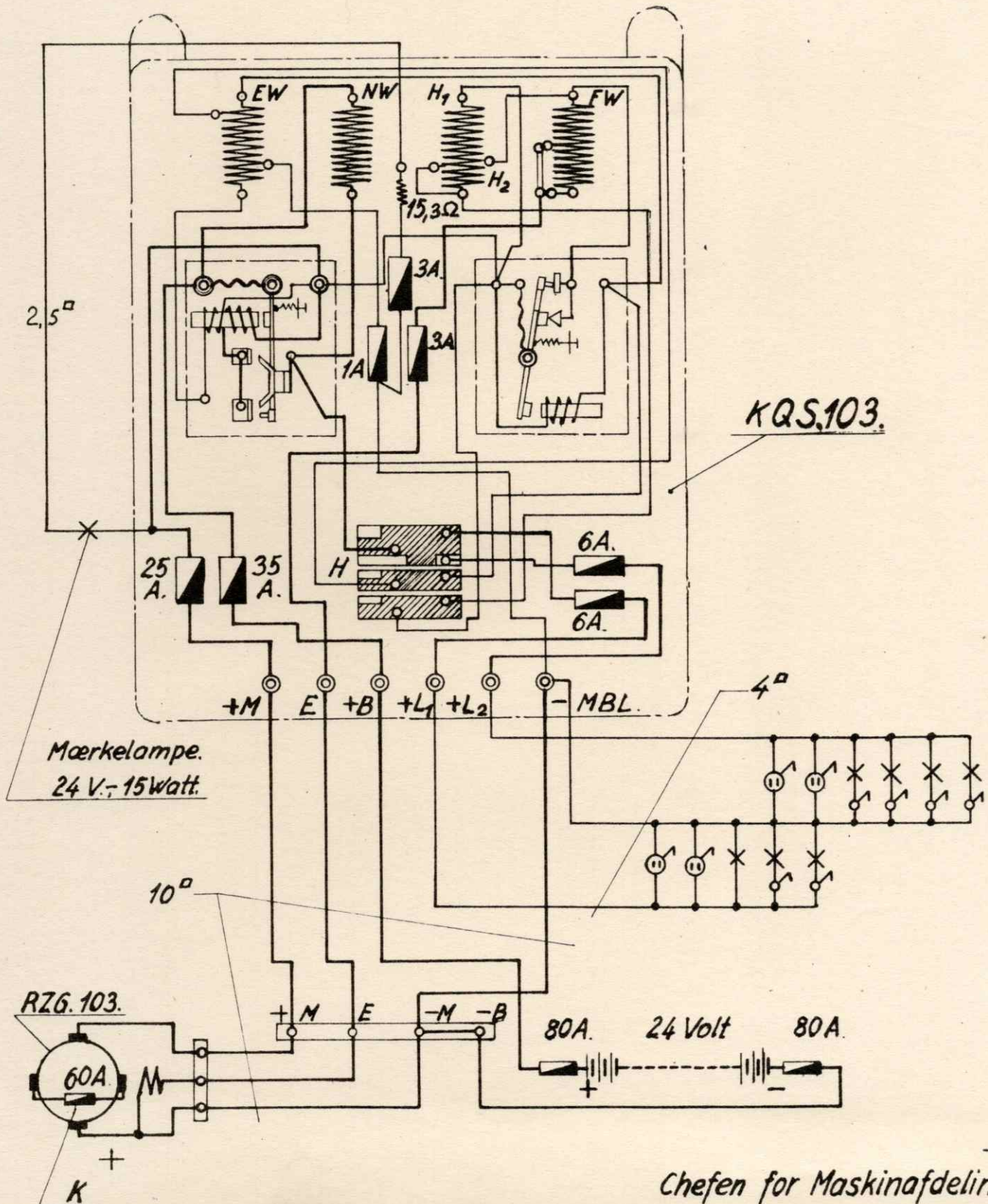

Chefen for Maskinafdelingen.

L.D. Nr. 28.

Rosenberg Dynamoanlæg.

Vogn Ltr. Ec. Nr. 6280.

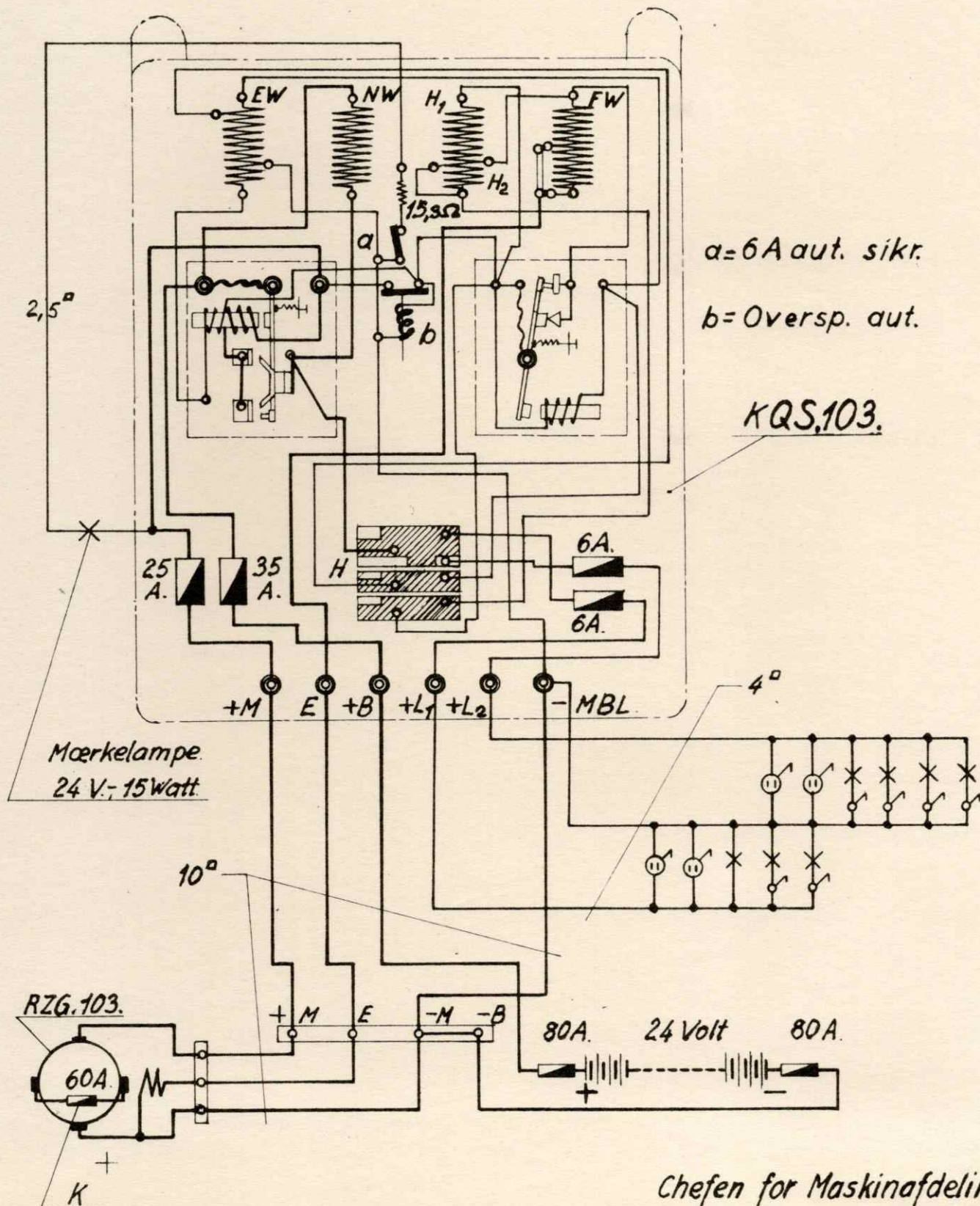

Chefen for Maskinafdelingen.

LD. nr. 28 A.

Rosenberg Dynamo Anlæg

Vogn Ltr. Ch Nr. 2141, 43, 44, 48-80

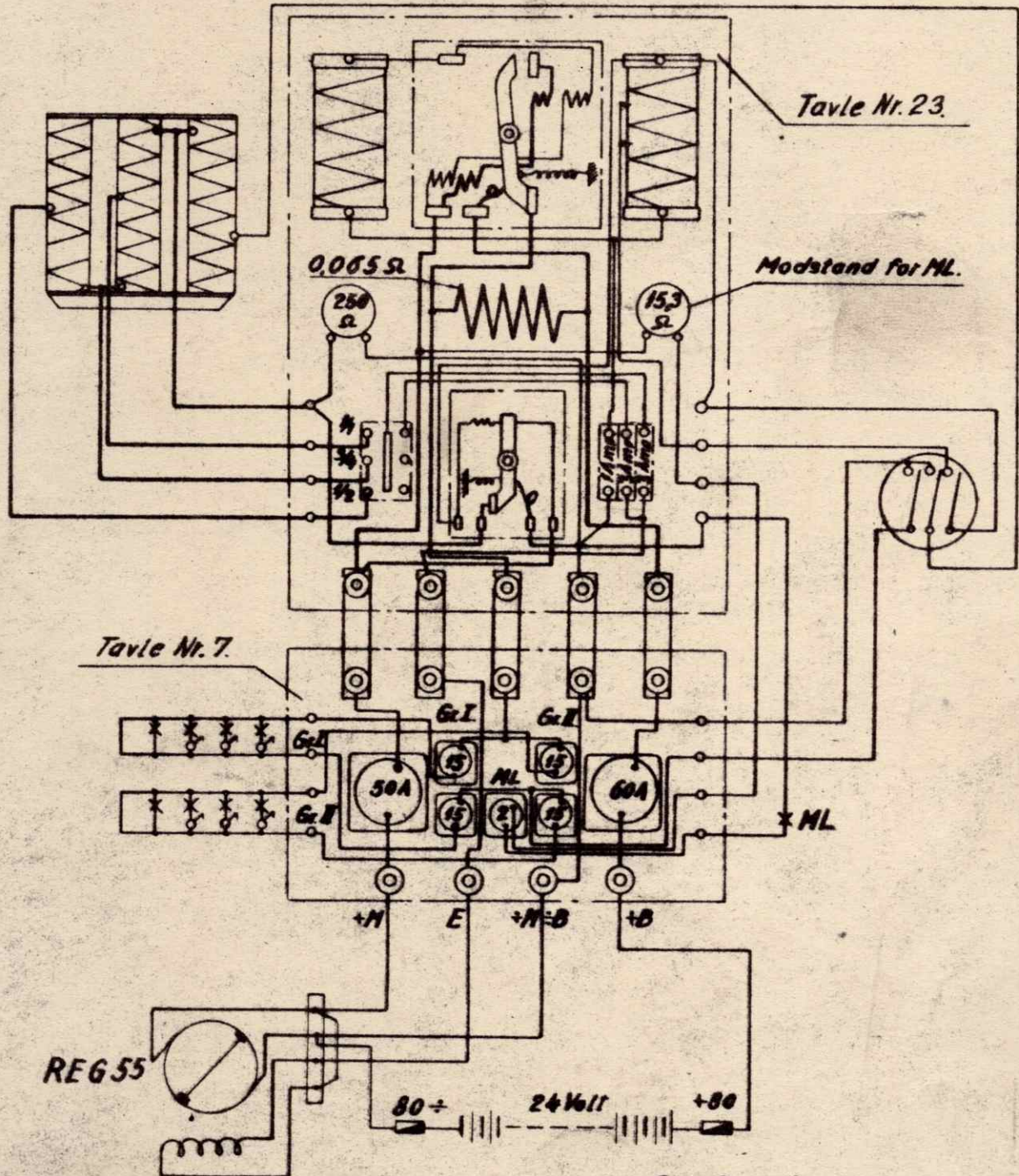

Chefen for Maskinafdelingen.

L.D. Nr. 29.

Rosenberg Dynamoanlæg

Vogn Ltr. DF Nr. 5157-54

Regulerings-
tavle Nr. 11.

Pintsch 54 VIII

Dynamorelais.

Spændingsbegrænser.

Mærkelampe
24V. 15W.

Tavle Nr. 9.

REG 55

Chefen for Maskinafdelingen.

L.D. Nr. 34.

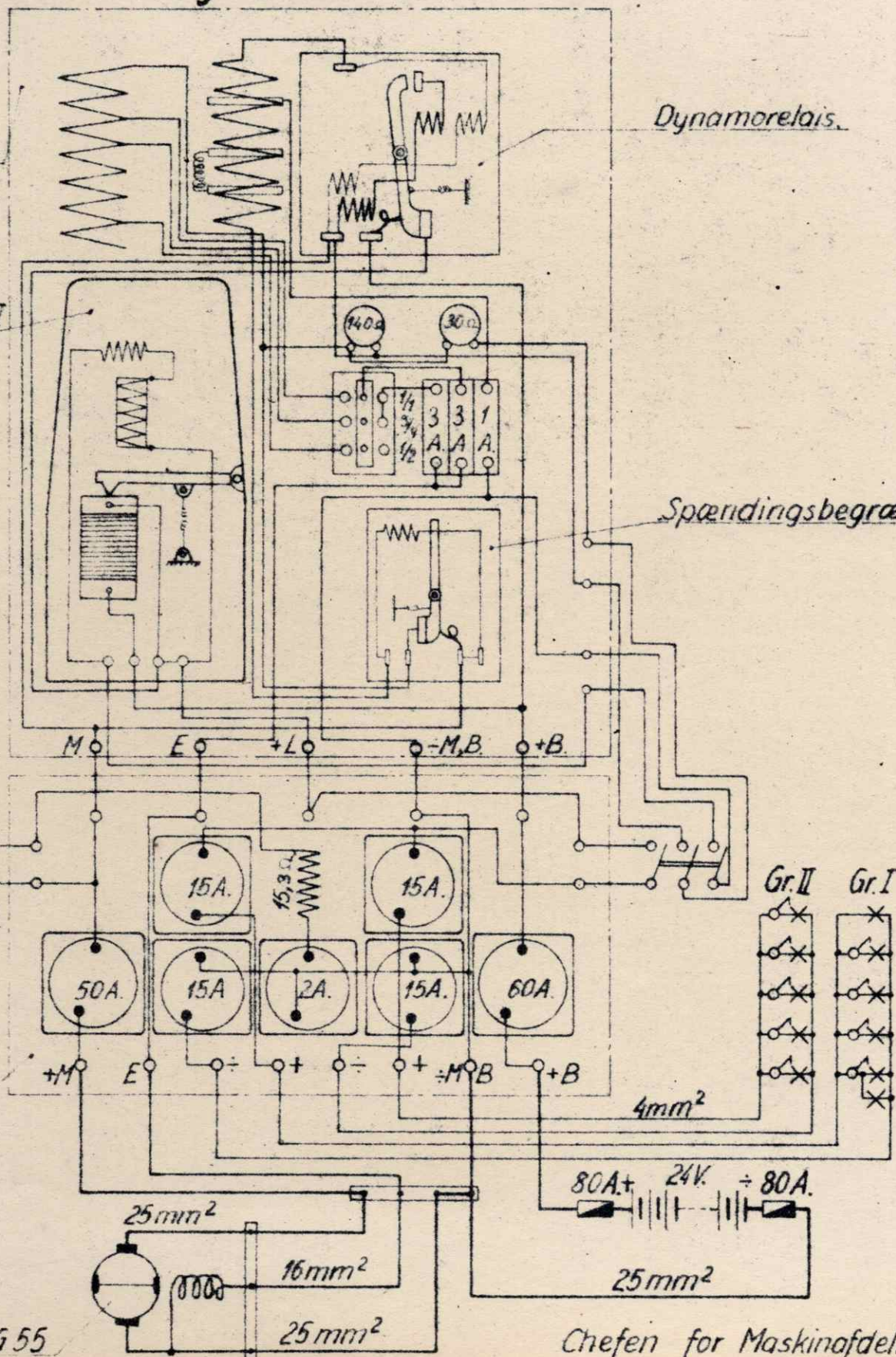

Pintsch-Dynamo

Vogn Ltr. Co Nr. CP

2542,44-47,50-54,2601-02,57,53,54

2701-02,41,45,46,62

CP : 2901,03-12,14,15,18-20,23-26,38,40-42

2844-51,53-85,2913-17,19-22,24,25,27,29

2930,32,34,36-42,44-52,57,59,60,62

CPM : 2994-99

CQM : 3501-03,09-24

3557-75

54^I WK.

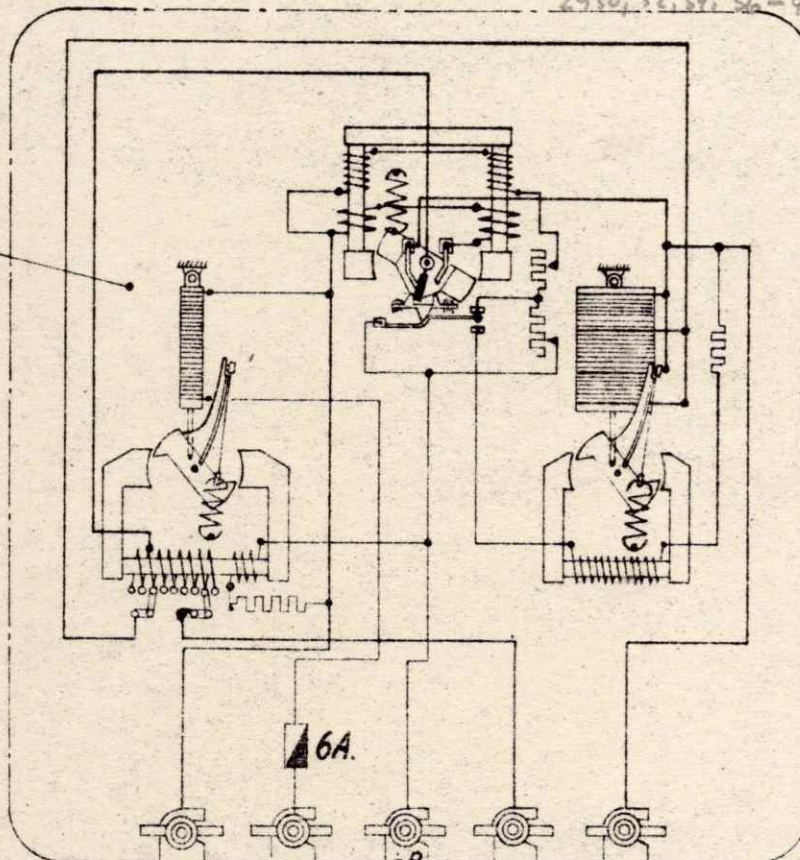

Tavle SP.

2,5 mm²

12

13

Mærkelampe

24V, 15W.

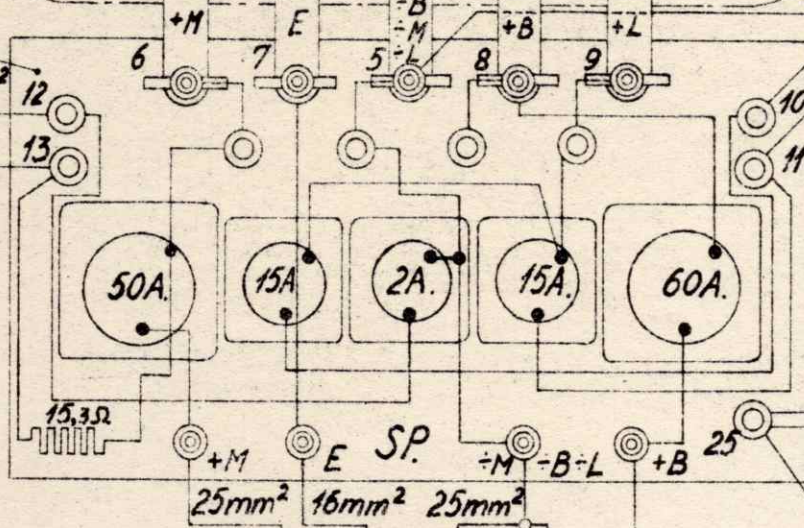

25mm²

4mm²

25mm²

4mm²

4mm²

4mm²

Remtræk: Klembræt.

Carantr.: Marinedåse (÷)

+

EP.

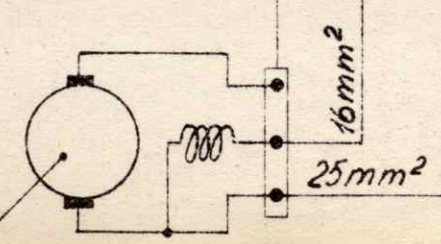

80A+ 24V ÷ 80A

25mm²

+

Chefen for Maskinafdelingen.

LD. Nr. 35.

Pintsch-Dynamo.

Vogn Ltr. Co Nr. 2652, 2763

CP 2918, 31, 43, 63

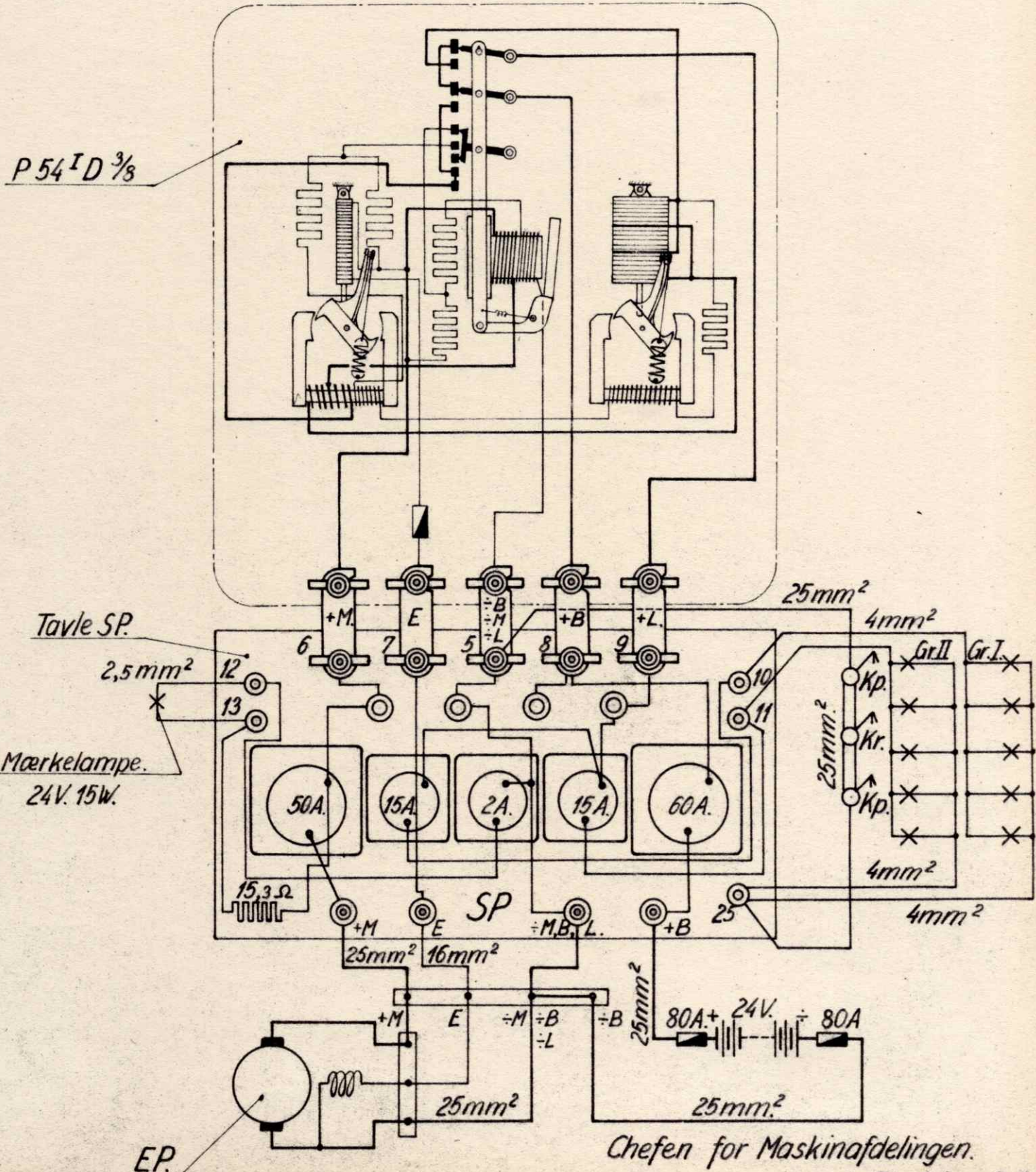

P 54^I D ³/₈

Tavle SP.

2,5 mm²

Mærkelampe.
24V. 15W.

EP.

Chefen for Maskinafdelingen.

LD. Nr. 38.

Pintsch-Dynamo.

Vogn Ltr. Nr. 2077, 78, 80, 81, 83, 84, 2147, 81-85, 91
 2220, 35, 42

CML : 2291

CHM : 2405, 06, 08

54 I D 3/8

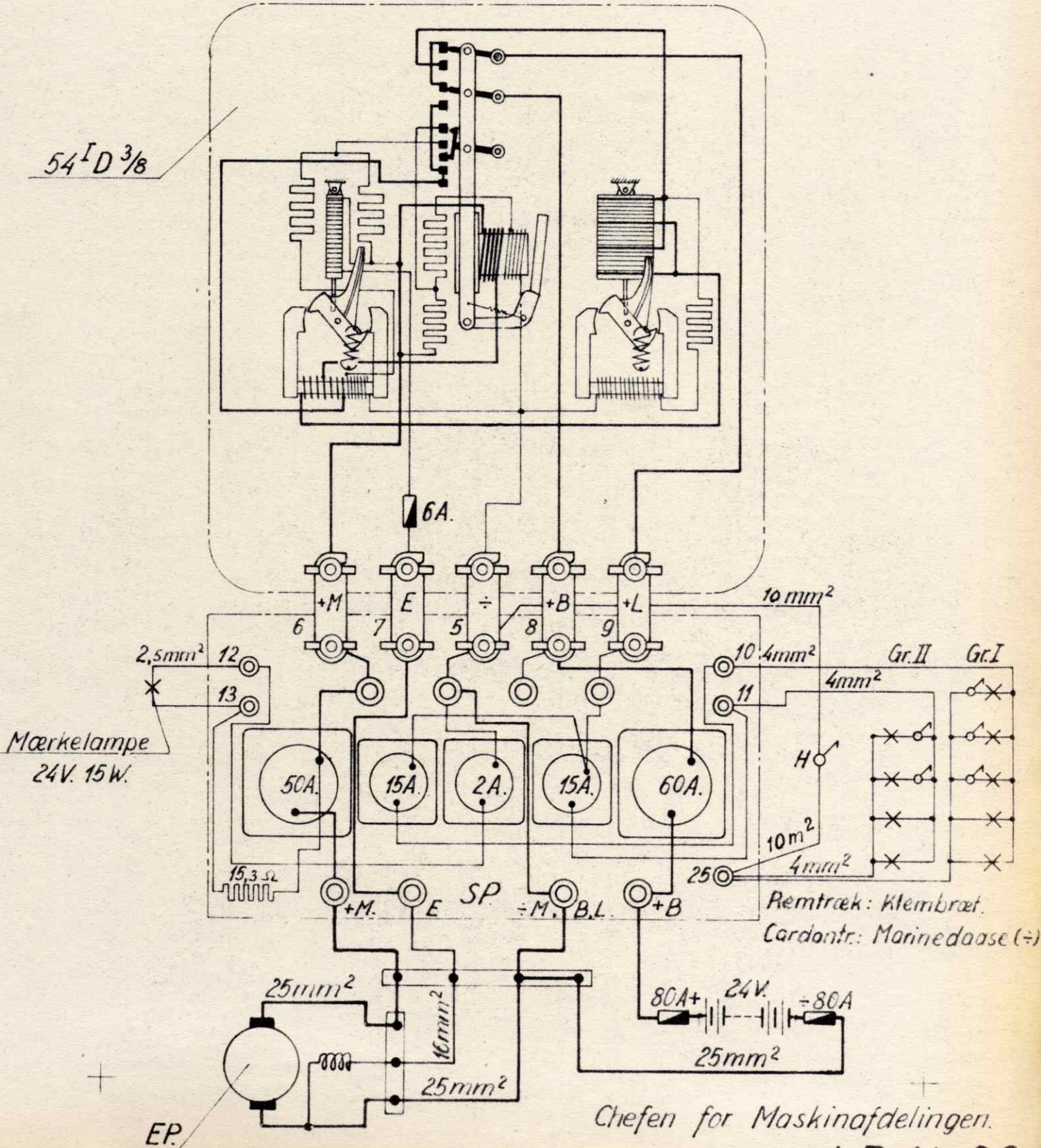

Mærkelampe
24V. 15W.

Remtræk: Klembræt.
Cardontr.: Marinedaase (=)

Chefen for Maskinafdelingen.

LD. Nr. 39.

Pintsch-Dynamo

Vogn Ltr. Nr.

AF 84, 86, 93
 FR 101-10
 ARM 155-57
 FSM 195, 196
 RT 205, 206

CH: 2006, 09, 34, 39, 57, 58
 60, 64, 66, 69, 72, 79, 82
 89, 90, 97, 2108, 19, 13
 15, 90, 95, 2234, 36, 37

CHL 2290
 CHM 2401, 03, 04
 CHE 2421-23, 25-27
 CHK 2448, 63, 64
 CSM 3058
 FB 4721-22
 FC 4757-60
 FE 4901-10
 11-35 (Varde sp)

54 I WK.

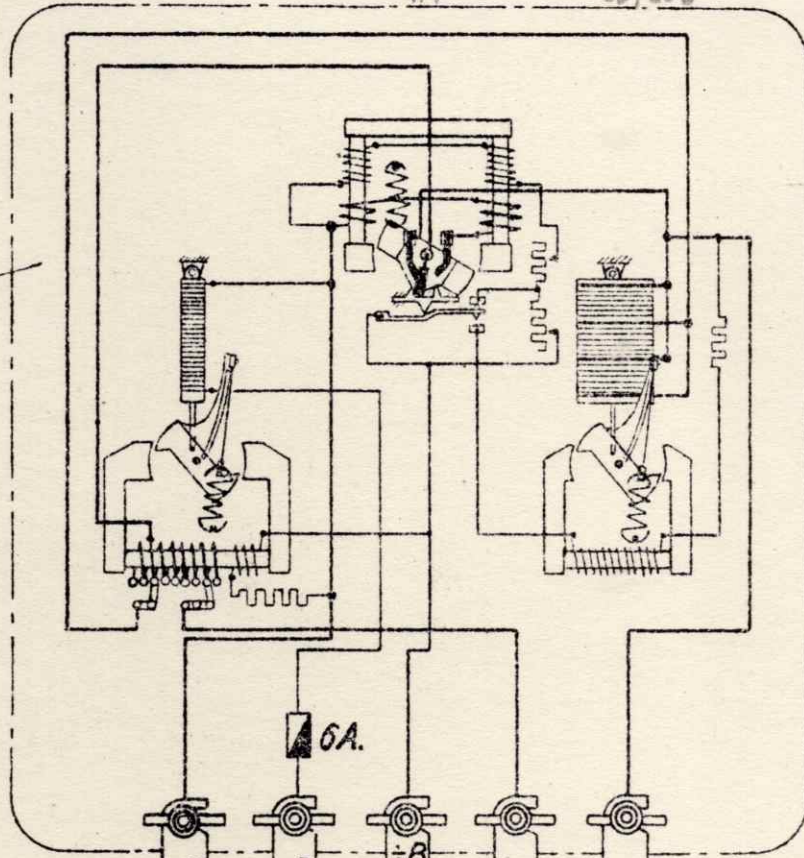

Tavle SP.

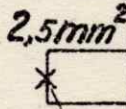

Mærkelampe
 24V. 15W.

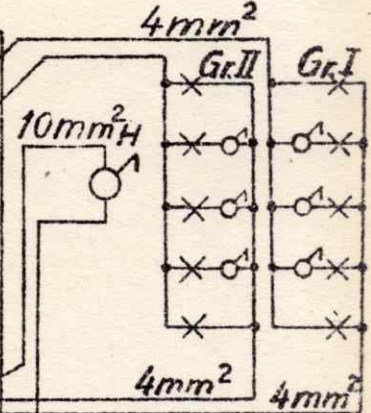
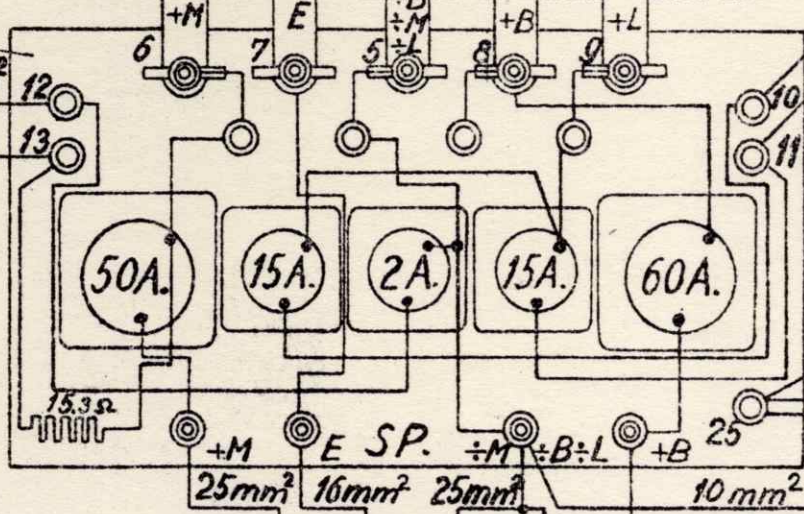

Remtræk: Klembræt.
 Cardantr.: Marinedoase (÷)

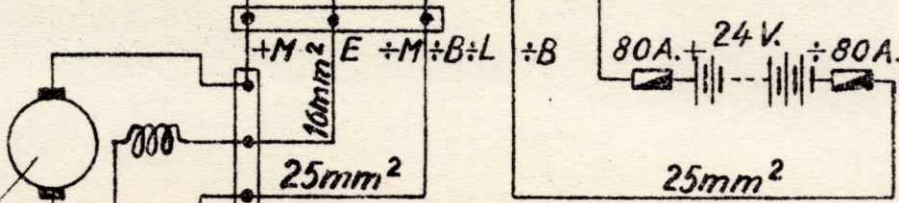

EP.

Chefen for Maskinafdelingen.

LD.Nr.43.

Lysanlæg med Dobbeltbatteri.

Vogn Ltr. _____ Nr. _____

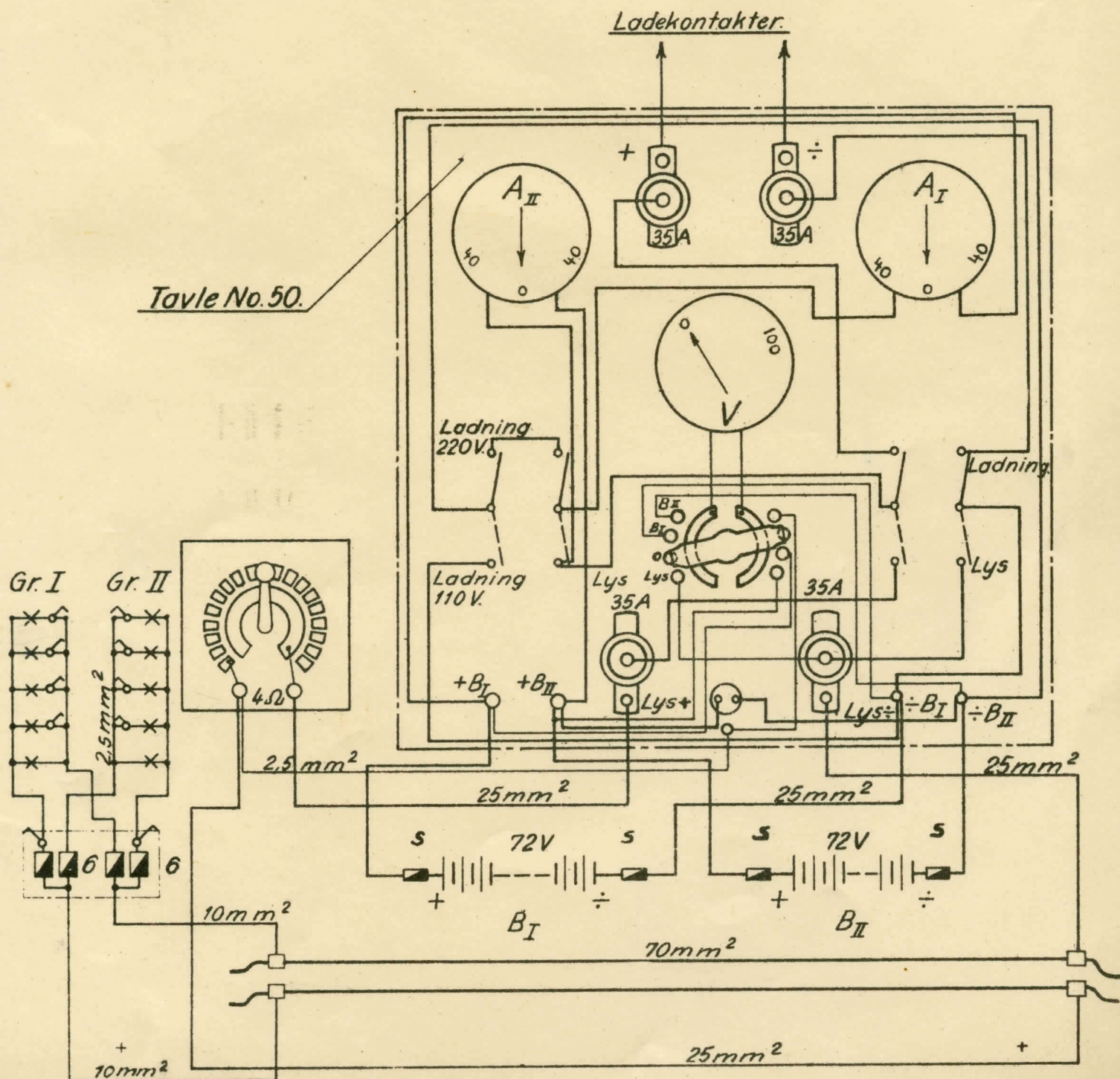

S = 35 Amp. for Batteri oppe i Vognen.

S = 80 Amp. for Batteri under Vognbunden.

Chefen for Maskinafdelingen.

LD.Nr.44.

Lysanlæg med Dobbeltbatteri.

Vogn Ltr. CM Nr. 2215, 33
CHK 2494

EF
Eha
viden dlyn.
6852, 54, 62-68, 70-74, 76-78

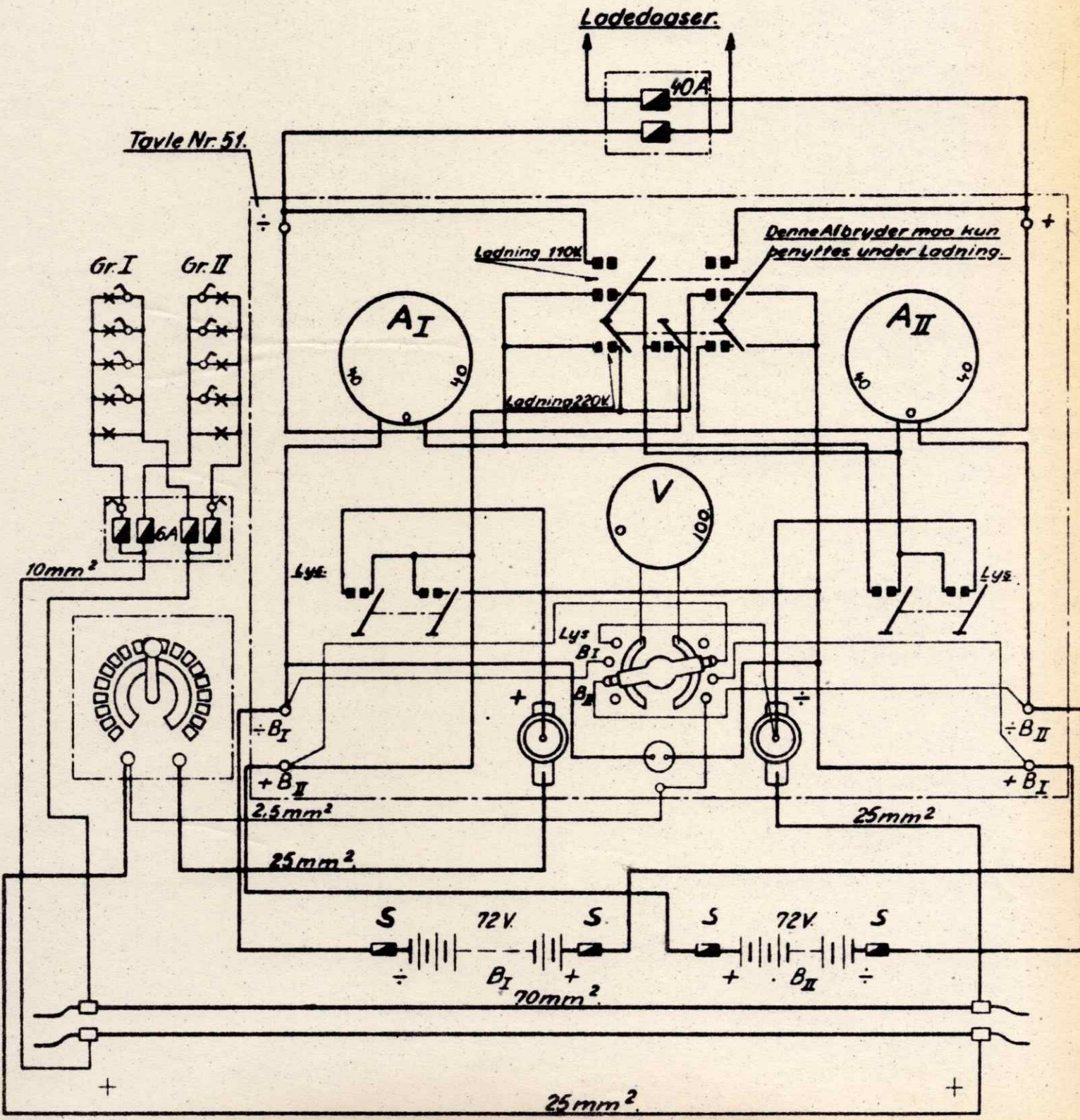

Tavle Nr. 51.

Denne Afbryder maa kun benyttes under Ladning.

S = 35 Amp. for Batterier oppe i Vognen.
 S = 80 Amp. for Batterier under Vognbunden.

Chefen for Maskinafdelingen.
 L.D. Nr. 45.

Lysanlæg med Dobbeltbatteri.

Vogn Ltr. _____ Nr. _____

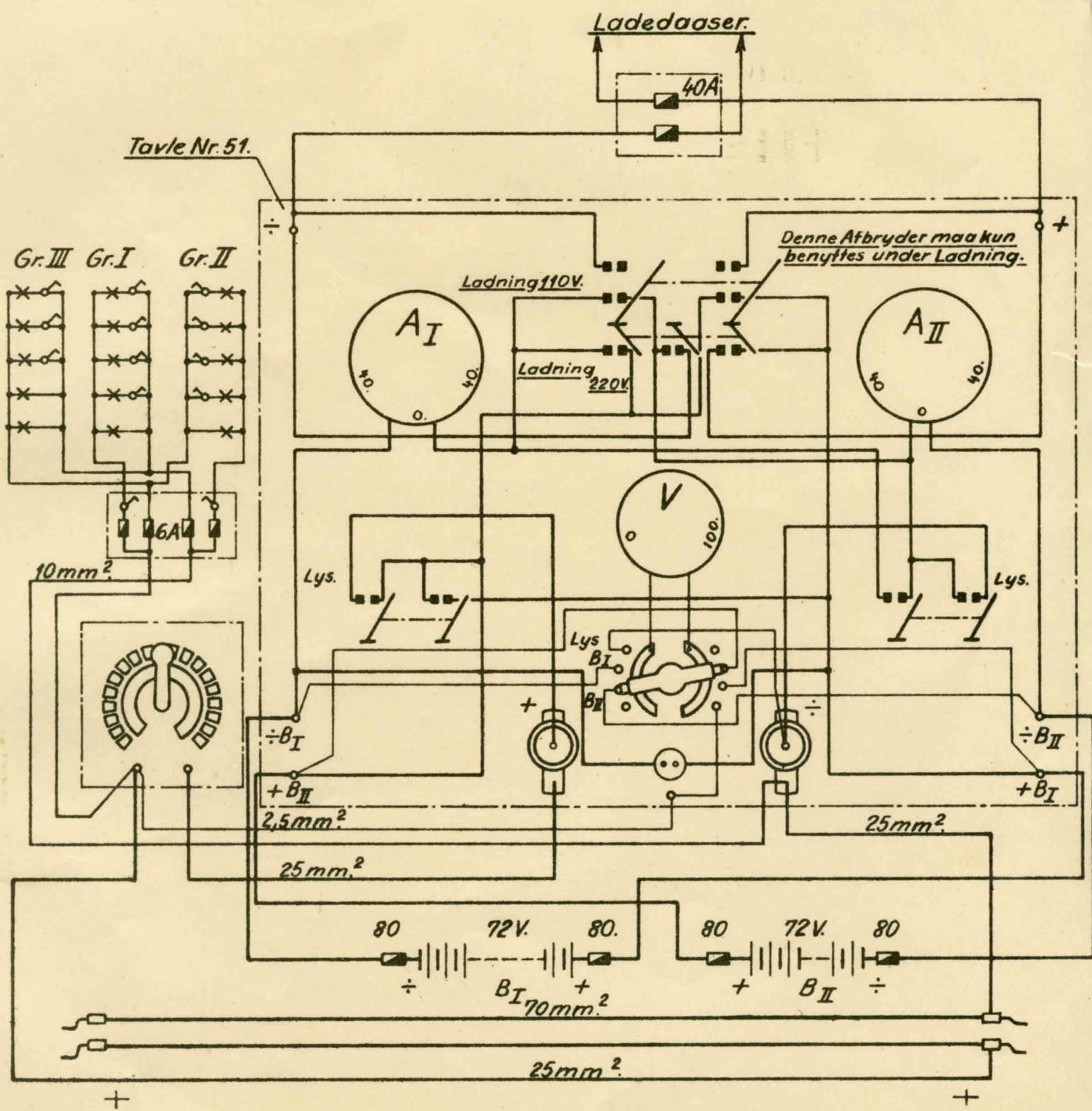

Chefen for Maskinafdelingen.

L.D. Nr. 46.

Pintsch-Dynamo.

Vogn Ltr. ^{F7T} _{F7M} Nr. ²⁰⁴ ₂₄₂₋₄₅

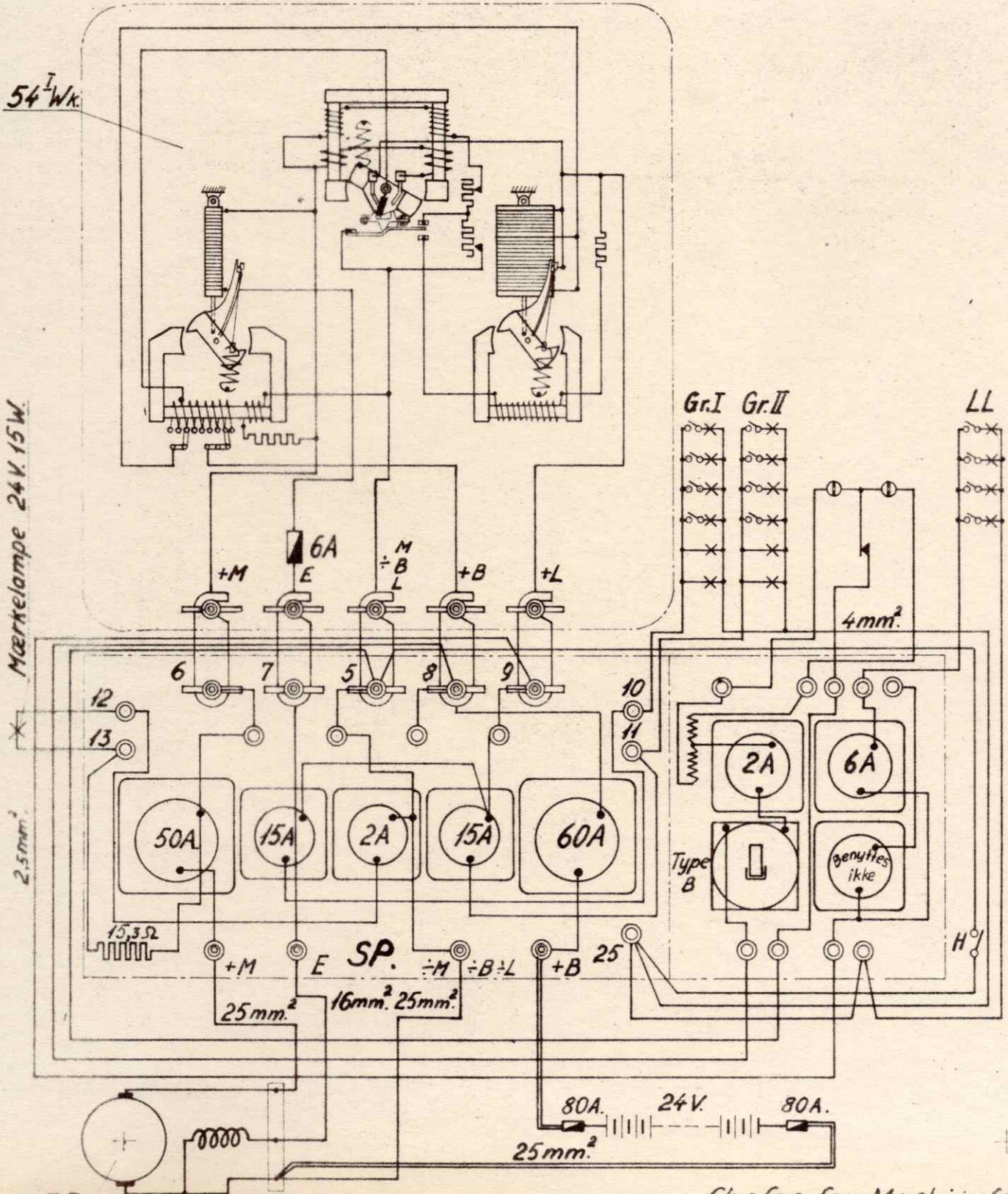

Mærkelampe 24V 15W

2.5mm²

E.P.

Tavle SP. ell. SU.

Chefen for Maskinafdelingen.

L.D.Nr. 47.

Rosenberg Dynamoanlæg.

Vogn Ltr. Nr.

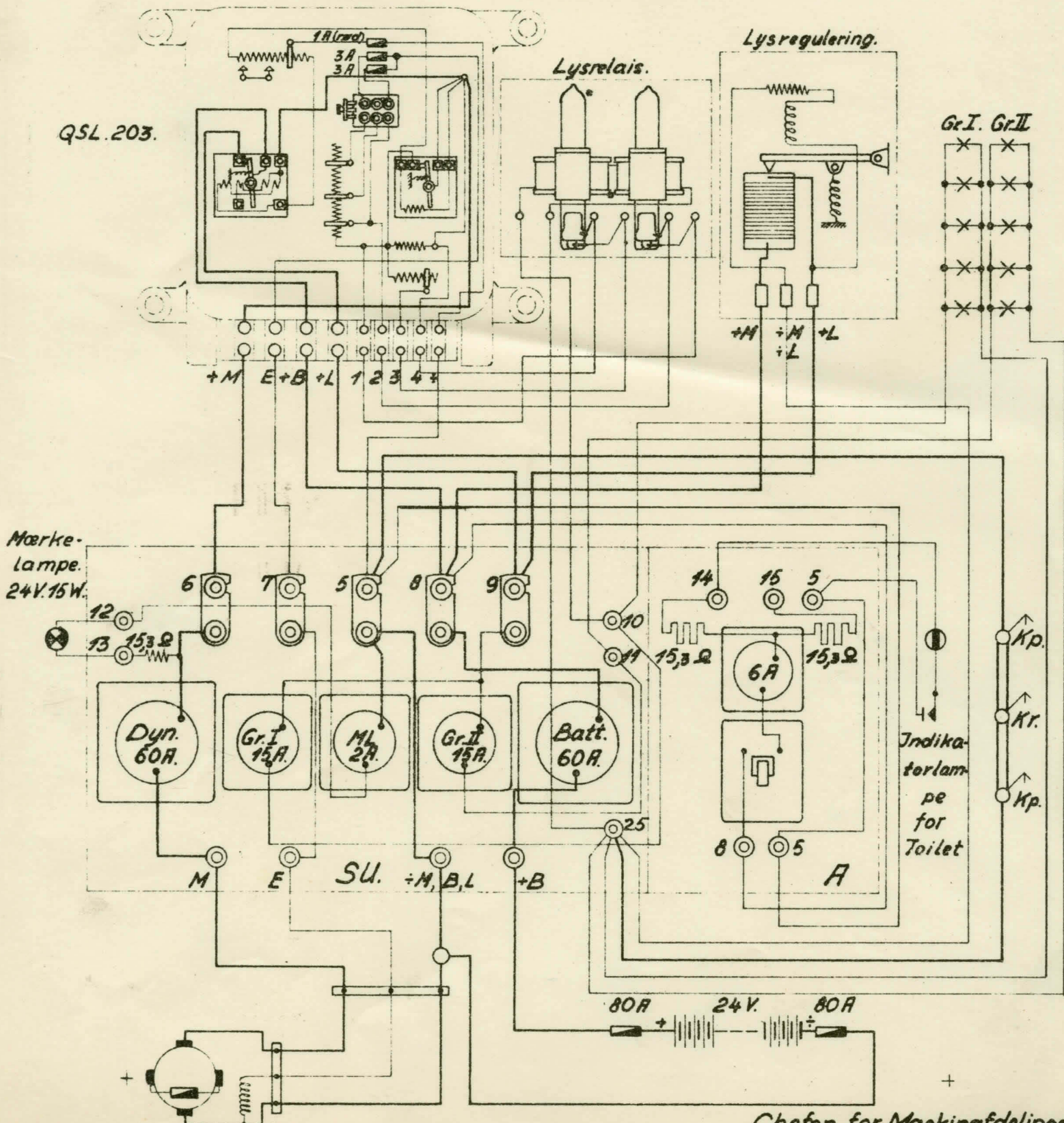

Chefen for Maskinafdelingen.

LD.Nr. 49.

Rosenberg Dynamoanlæg.

Vogn ltr. nr. som LD57

efter ændr.

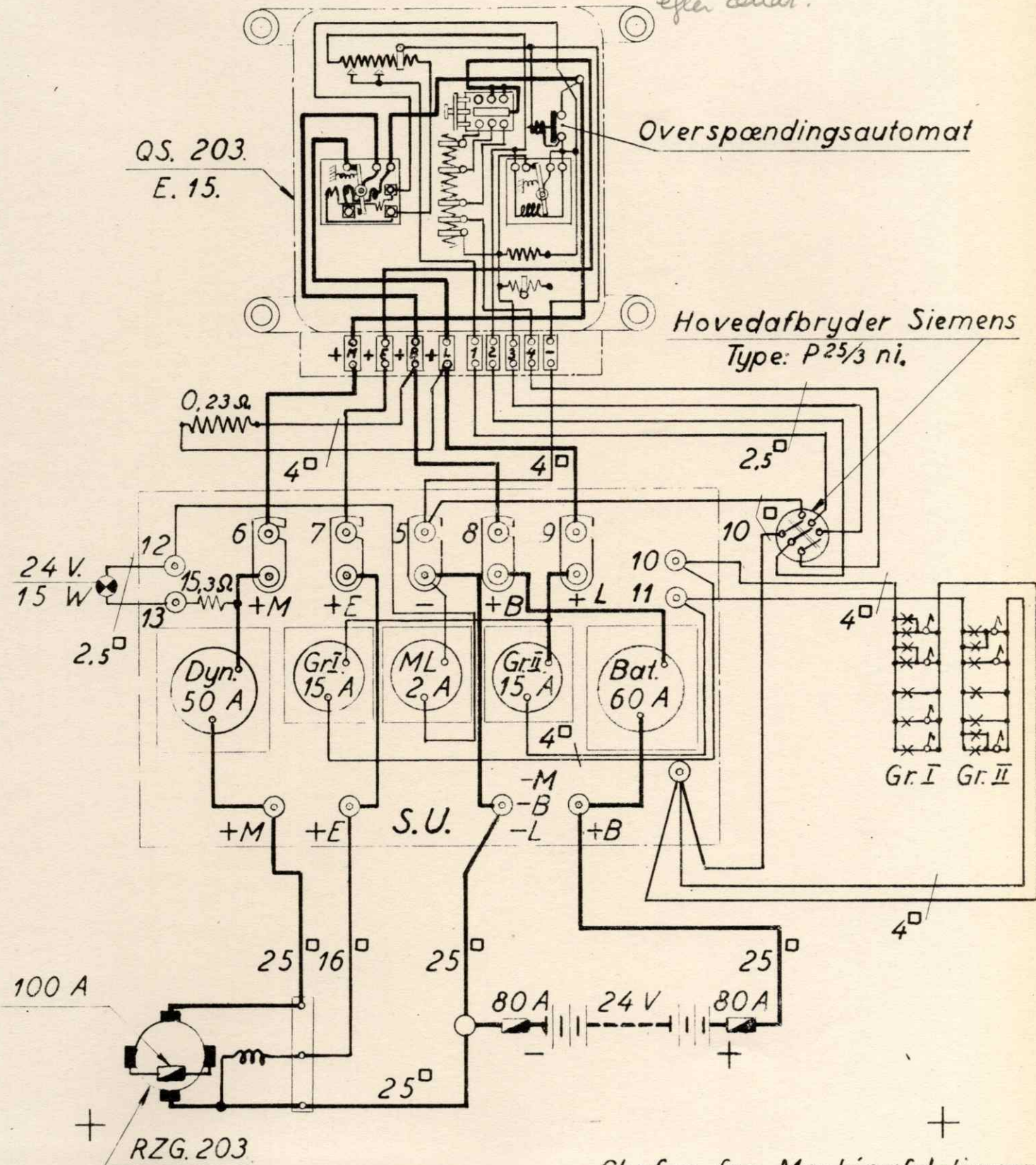

Q.S. 203
E. 15.

Over-spændingsautomat

Hovedafbryder Siemens
Type: P25/3 ni.

24 V.
15 W

Dyn.
50 A

Gr. I
15 A

ML
2 A

Gr. II
15 A

Bat.
60 A

Gr. I Gr. II

100 A

RZG. 203

Chefen for Maskinafdelingen.

LD. nr. 51 A.

Rosenberg Dynamoanlæg.

se LD. 97, 97 A

Vogn Ltr. CLE Nr. 1684-99

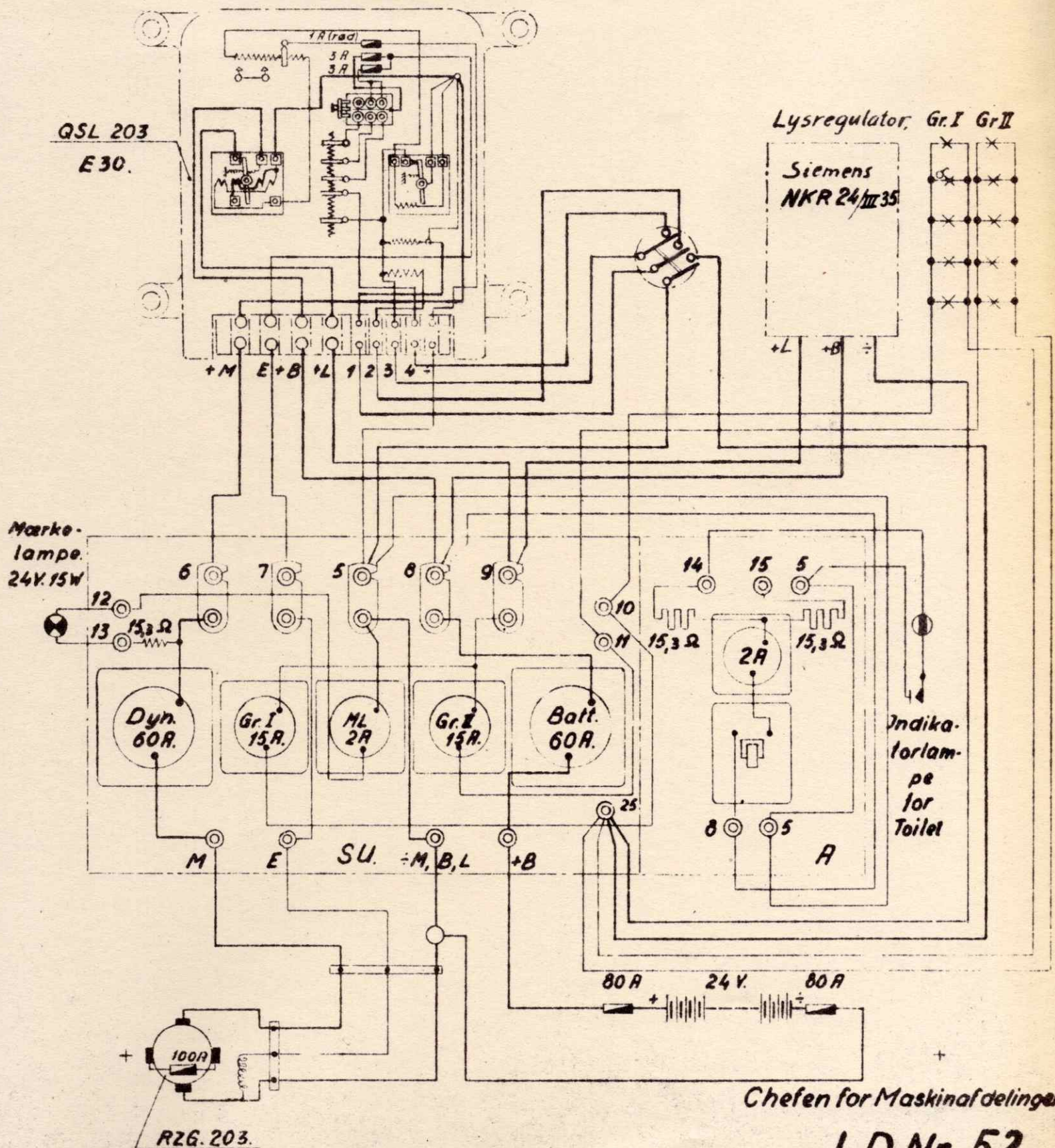

Chefen for Maskinaldelingen

LD. Nr. 52

Pintsch-Dynamo

Vogn Ltr. CP Nr. 2828-34, 98-2901, 03, 05-11
3202, 04-06, 09-10, 16-59
3301

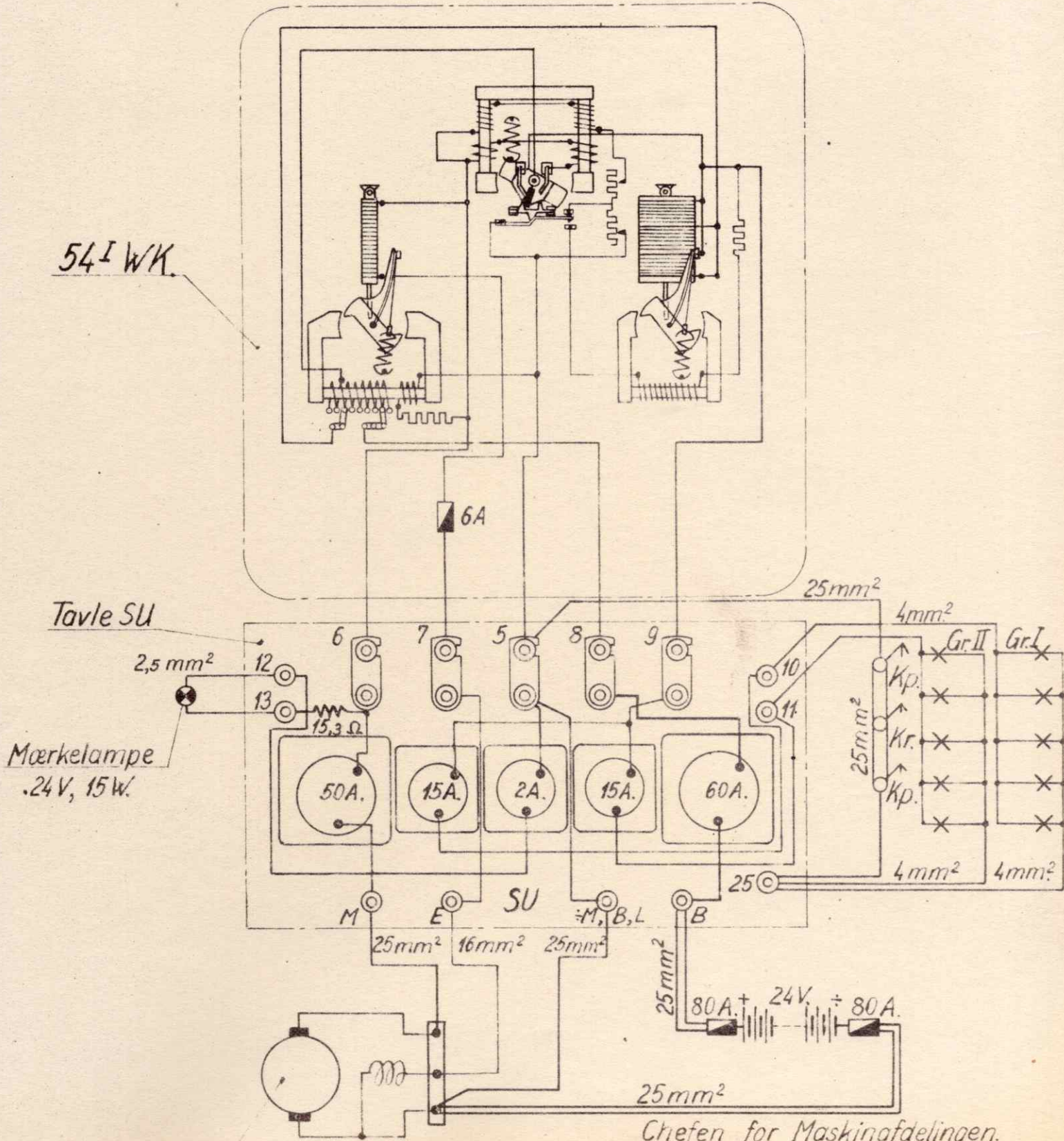

Chefen for Maskinafdelingen.

LD. Nr. 53.

Pintsch-Dynamo.

Vogn Ltr. CH Nr.

2001, 23, 26, 38, 51-56, 59, 61-63, 65, 67-68,
70-71, 73-76, 85-88, 91-2105, 07, 09-10,
14, 19, 31, 33-39, 86, 88, 92, 94, 96-99
2201-02, 32

CML 2283
CHE 2424
CHK 2449, 79, 93, 96
98, 99

54I WK.

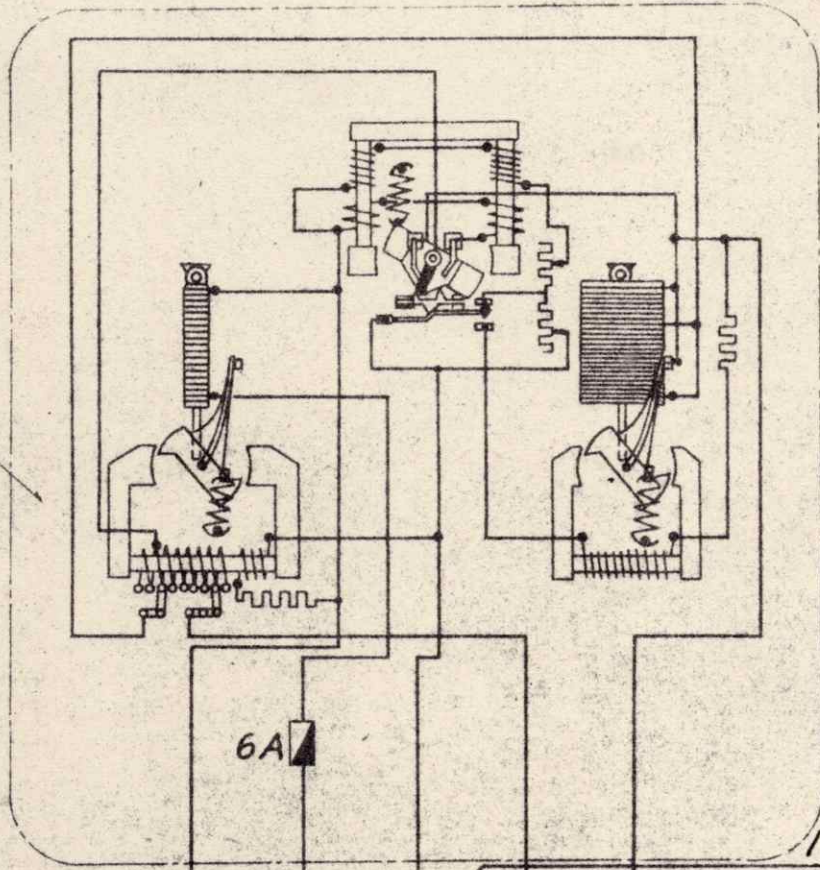

Tavle SU.

Mærkelampe
24V., 15W.

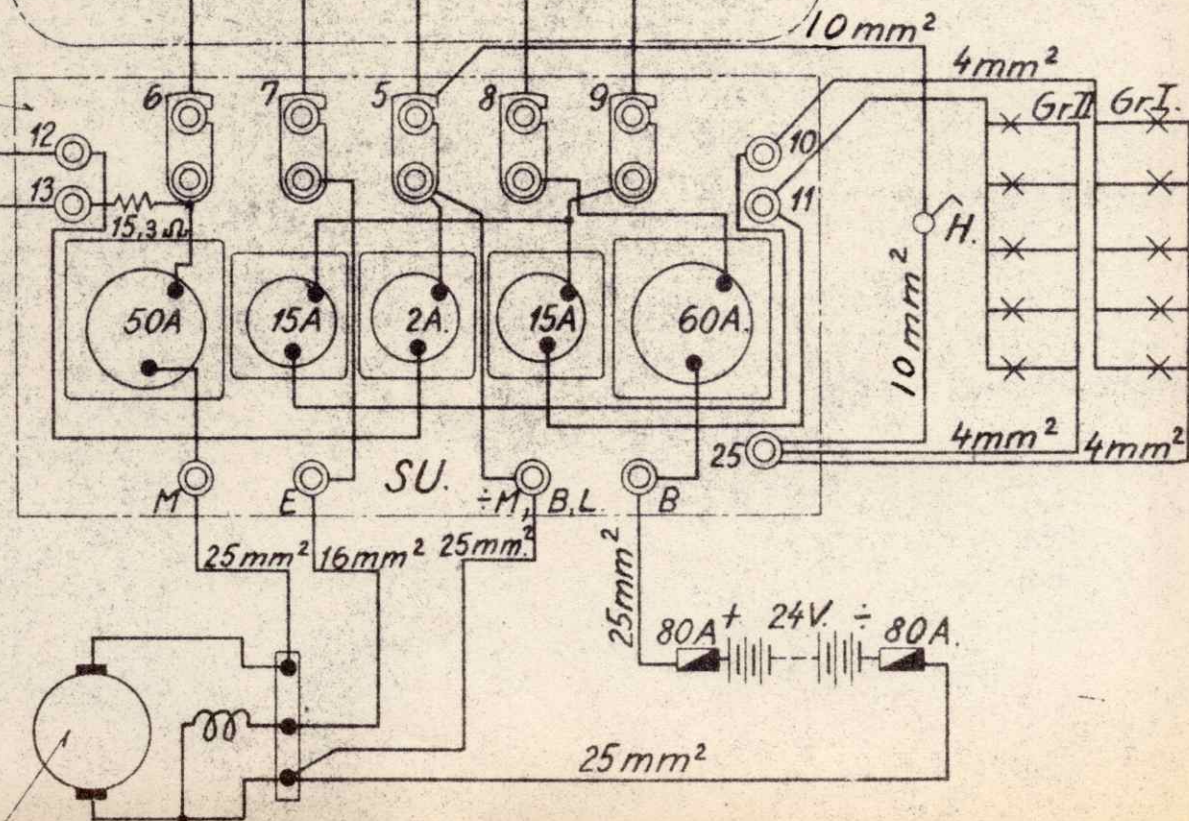

EP.

LD. Nr. 54.

Thrige - Dick Dynamoanlæg.

Vogn Ltr. Fr Nr. 273-84

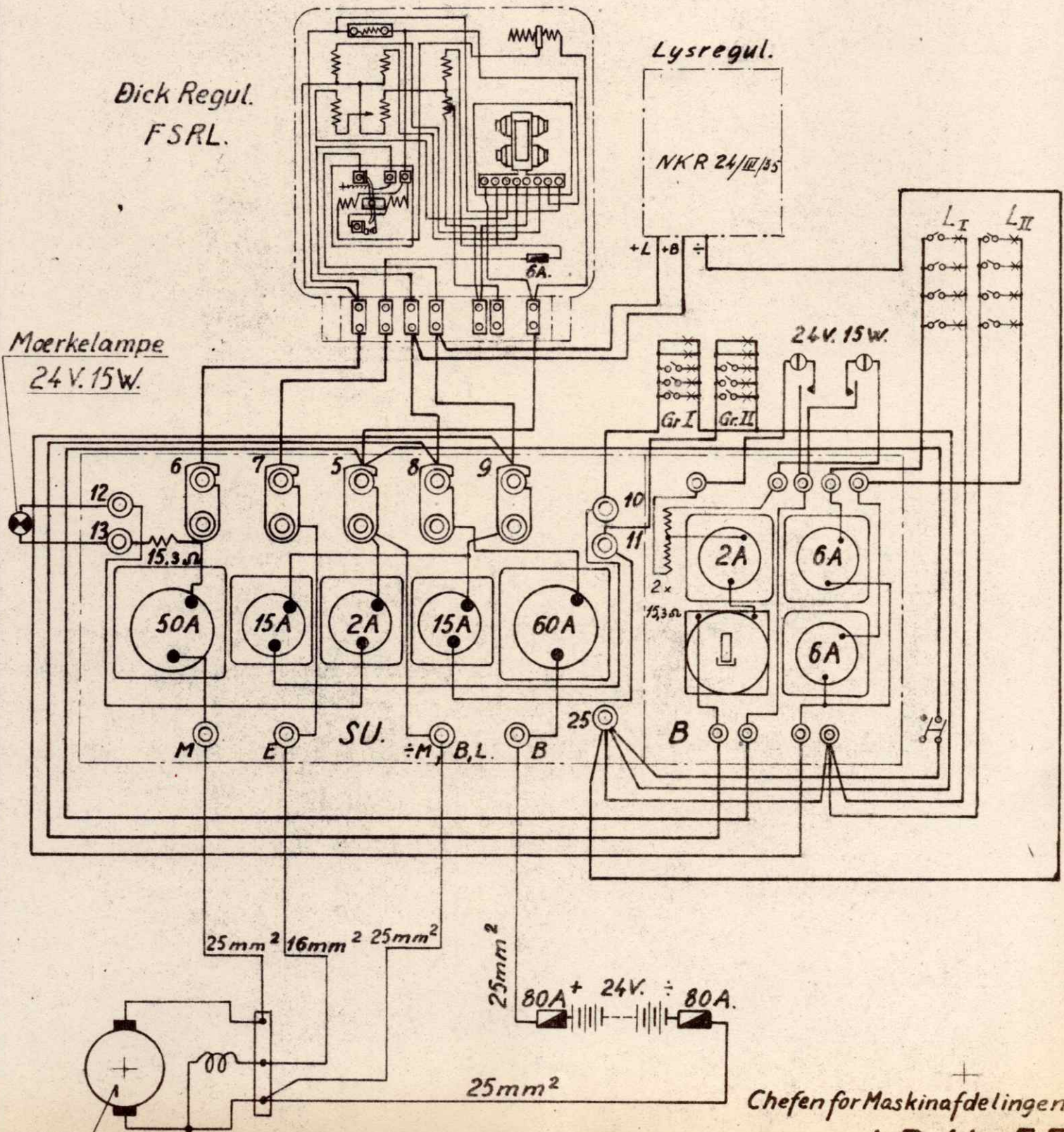

CF.12

Rev. 30-6-52

Chefen for Maskinafdelingen.

LD. Nr. 55.

Rosenberg Dynamoanlæg.

Vogn Ltr. Nr.

CR 3609-18, 21, 27, 29-30
 CRM 3601, 19-20, 23-25, 28, 31-32, 35-37, 41-57, 60-61, 63-66, 68-69, 79
 CRS 3602-08, 58-59, 62, 67, 70-78

Tavle Nr. 34

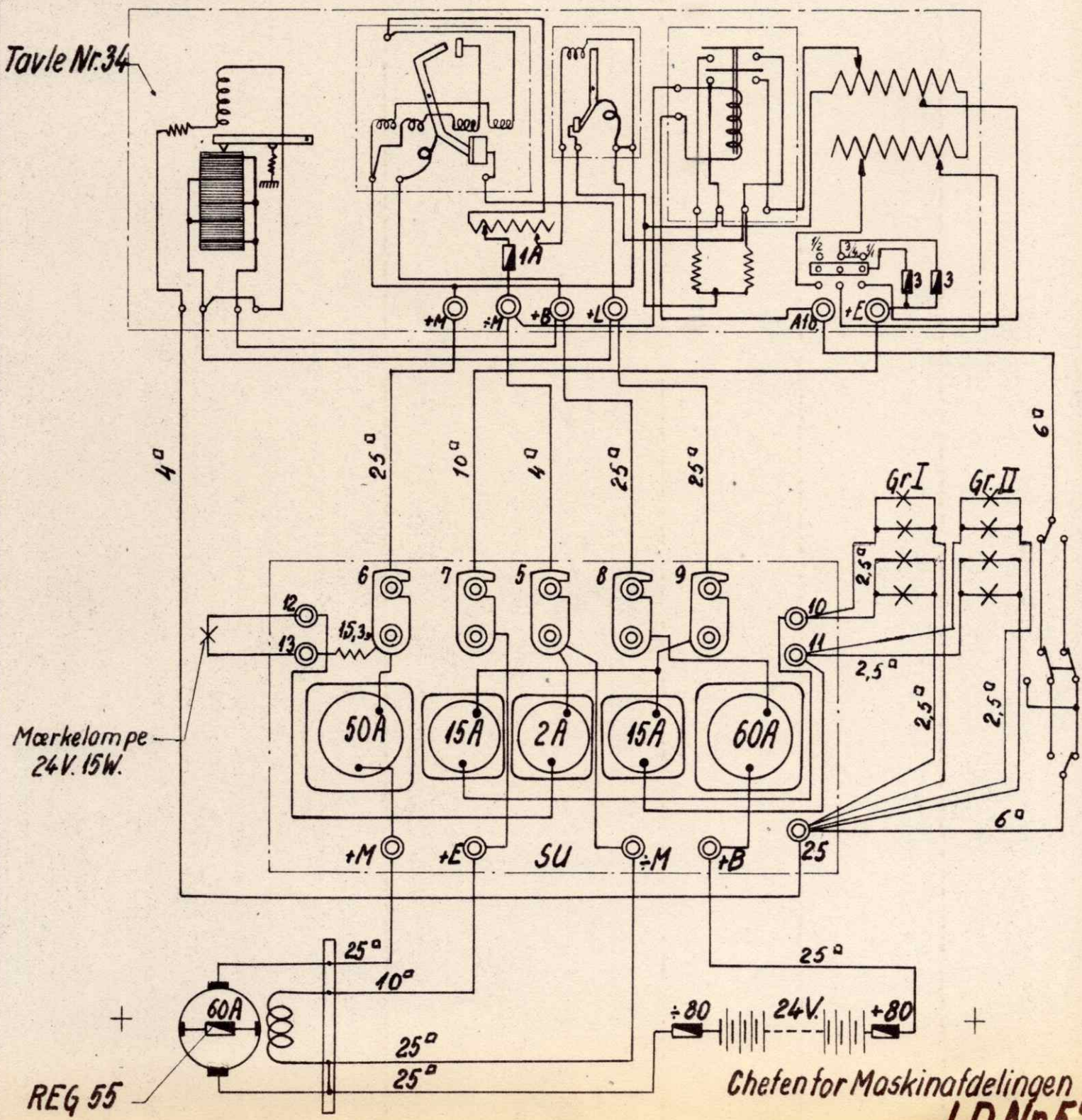

Mærkelampe
24V. 15W.

REG 55

Chefen for Maskinafdelingen

LD.Nr. 57

Pintsch - Dynamoanlæg.

Vogn Ltr. FRM Nr. 149-53
FSH 191-94

54 I W/K.

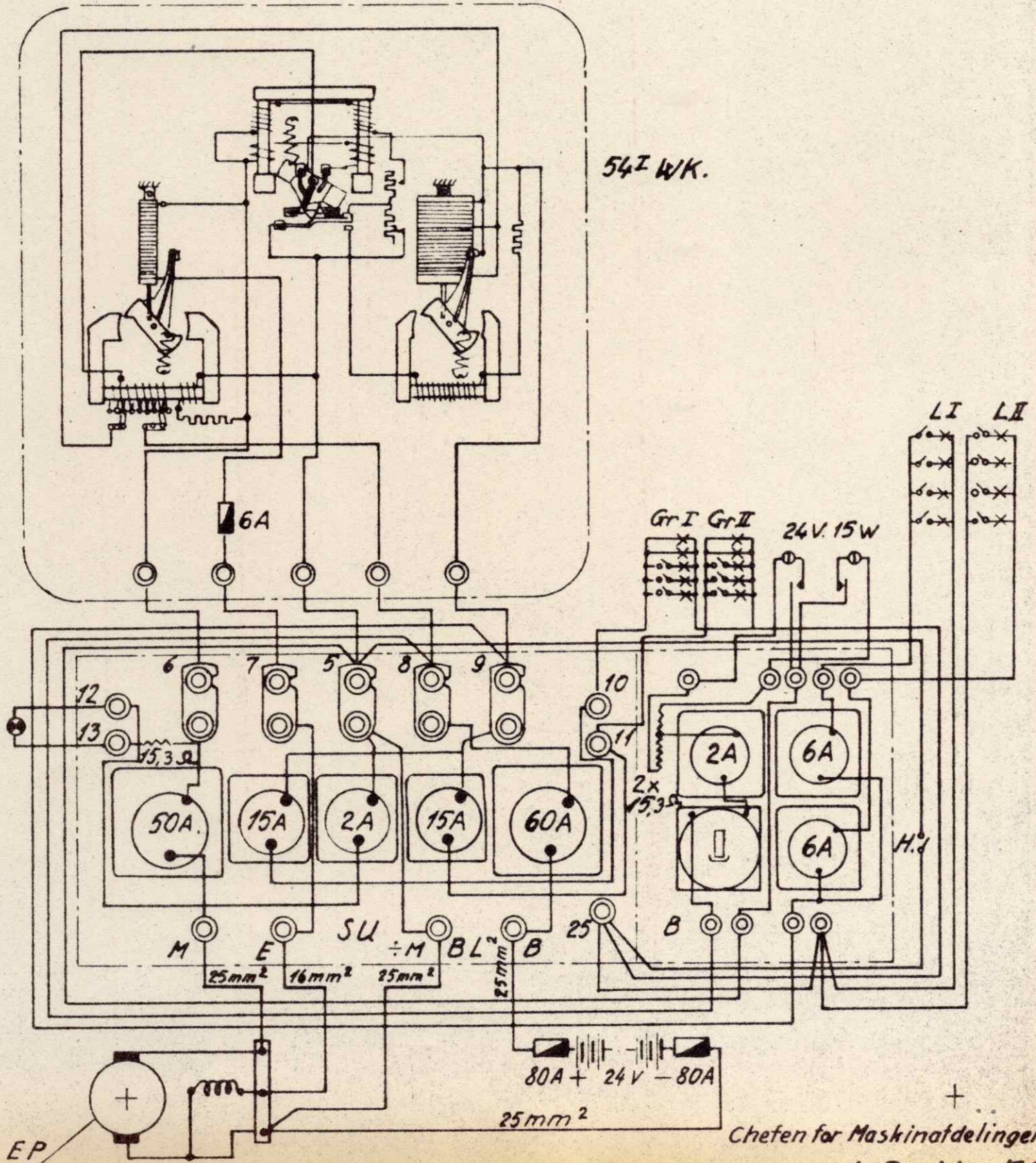

Chefen for Maskinatdelingen.

LD. Nr. 58.

Rosenberg Dynamoanlæg.

Vogn Ltr. Do Nr. 5627-32
DR 5857-63

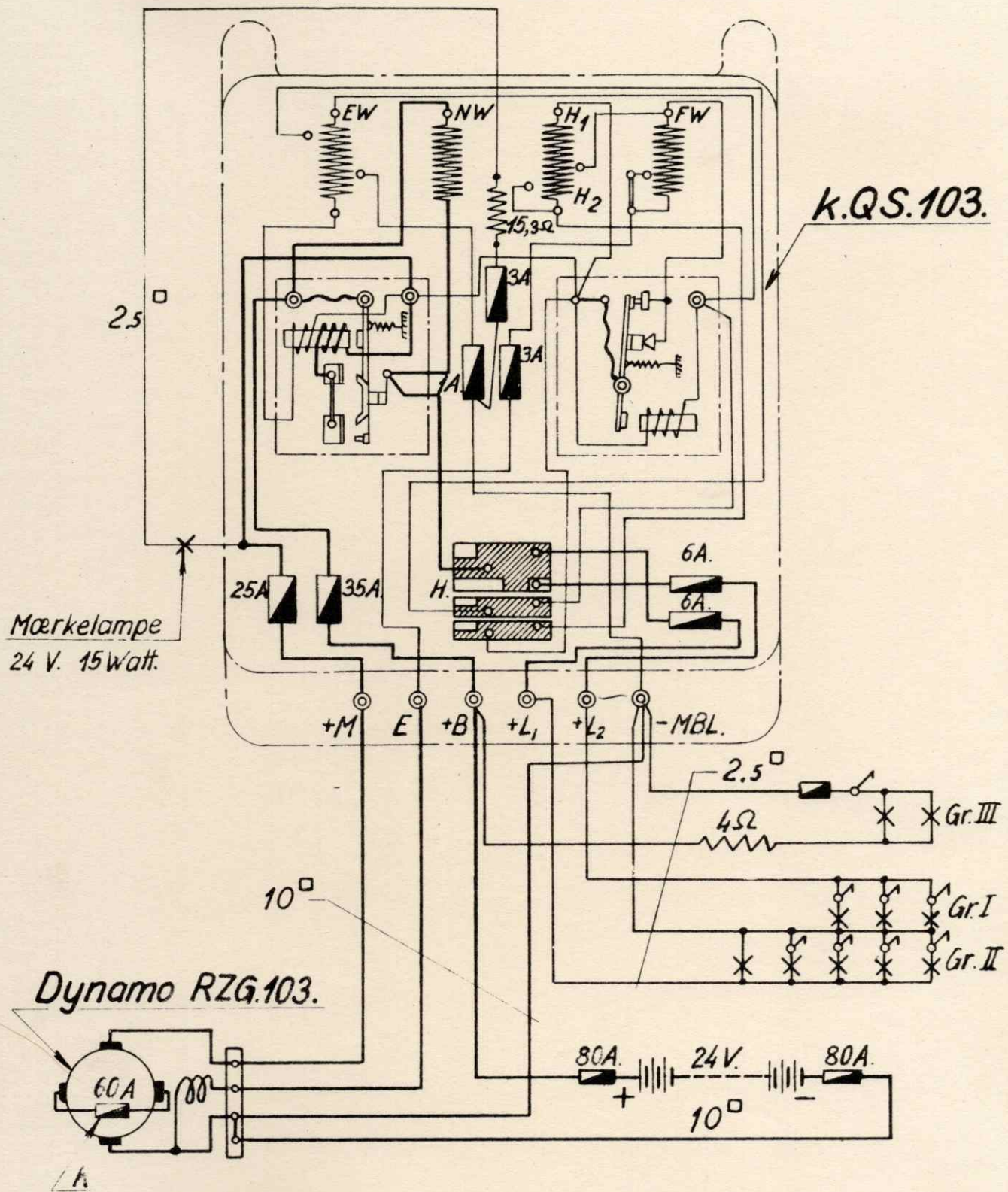

Chefen for Maskinafdelingen.

LD. nr. 61.

Rosenberg Dynamoanlæg.

Vogn ltr. ^{Samme} nr. Sam LD 61

(efter andr.)

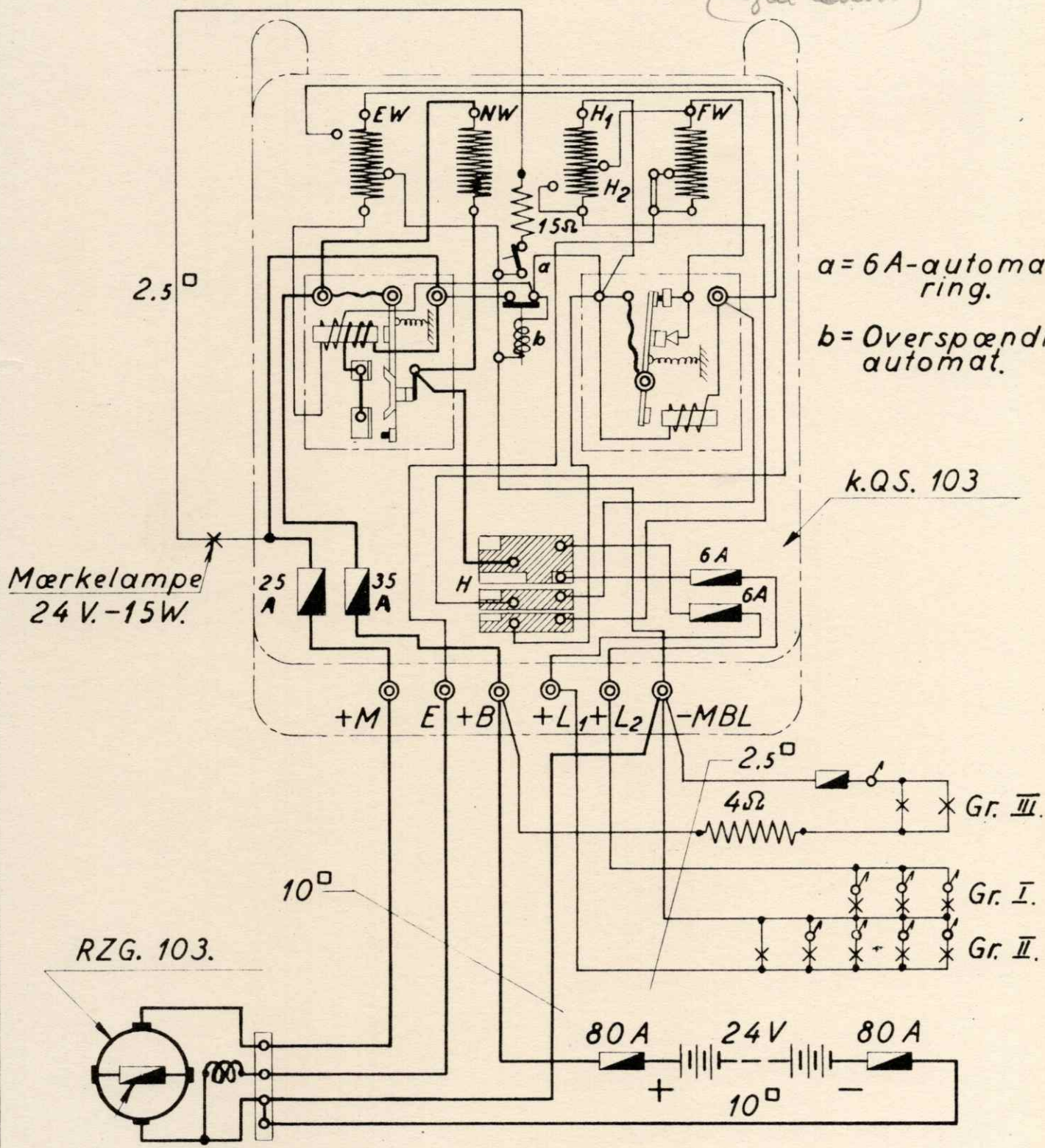

a = 6A-automatsikring.

b = Overspændingsautomat.

k.QS. 103

Mærkelampe
24 V.-15W.

25 A

35 A

6 A

6 A

2.5□

4Ω

Gr. III.

Gr. I.

Gr. II.

RZG. 103.

10□

80 A

24 V

80 A

10□

60 A

Chefen for Maskinafdelingen.

LD. nr. 61A.

Pintsch-Dynamo

Vogn Ltr. CP Nr. 2835-37, 39, 86-97

3201, 03, 07, 08, 14-15

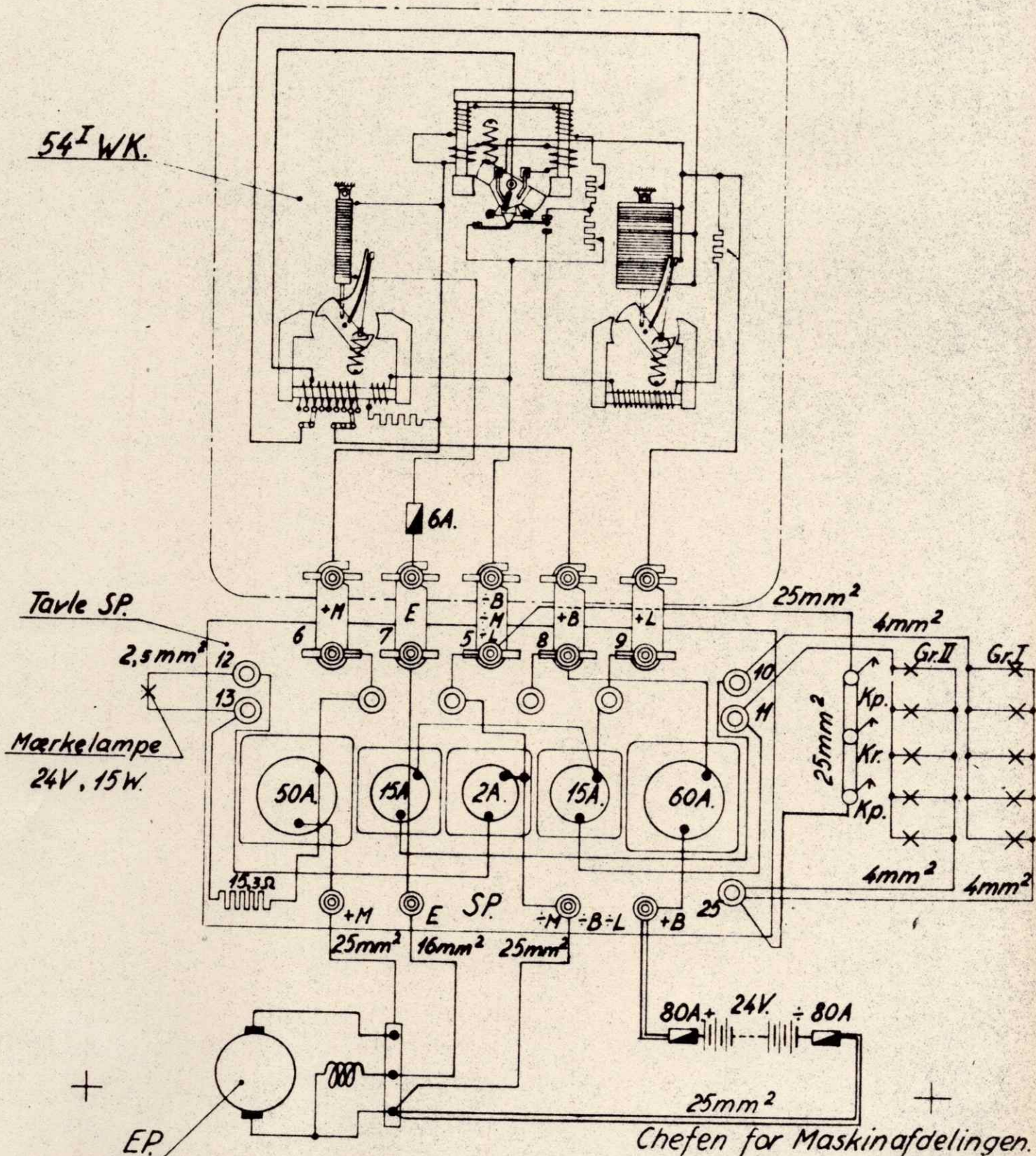

Pintsch Dynamo.

Vogn Ltr. CxM Nr. 4501-12, 18-30

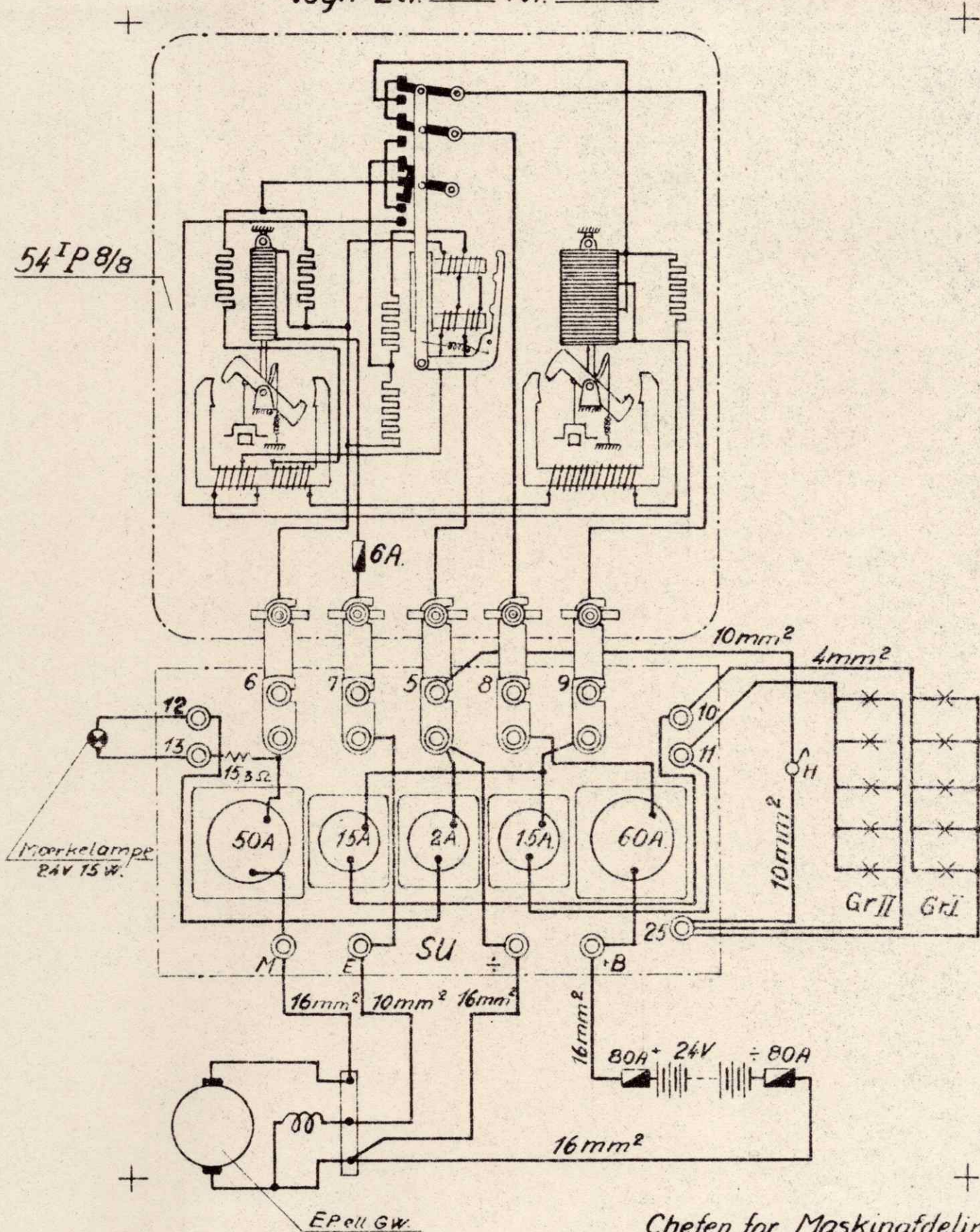

Chefen for Maskinafdelingen.

L.D. Nr. 63.

Rosenberg Dynamoanlæg.

Vogn Ltr. CL Nr. 1501-46, 48-1612

QSL. 203.
E. 30.

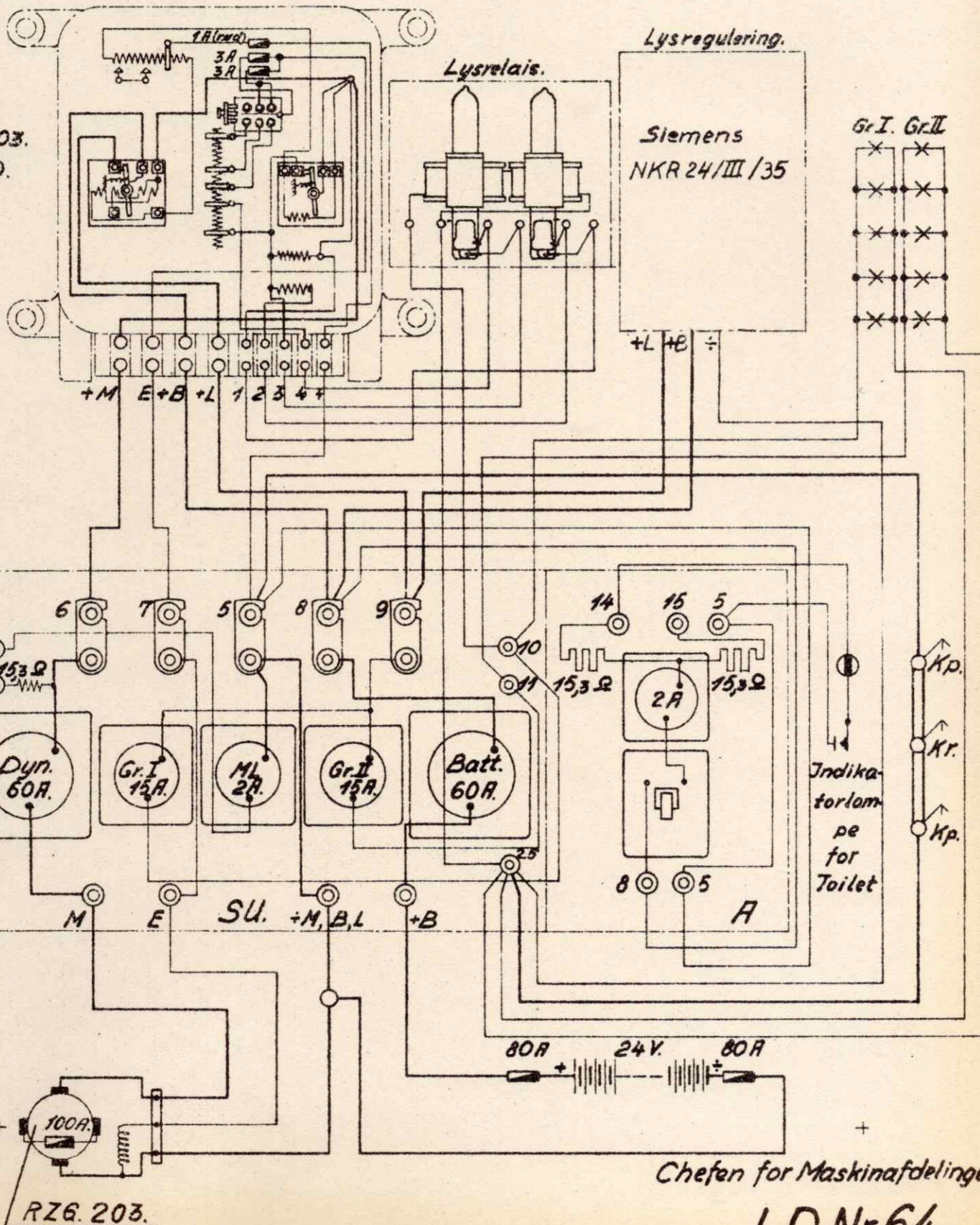

Chefen for Maskinafdelingen

LD.Nr 64.

Rosenberg Dynamoanlæg.

Vogn Ltr. D3 Nr. 5402,04,06-08,10-16

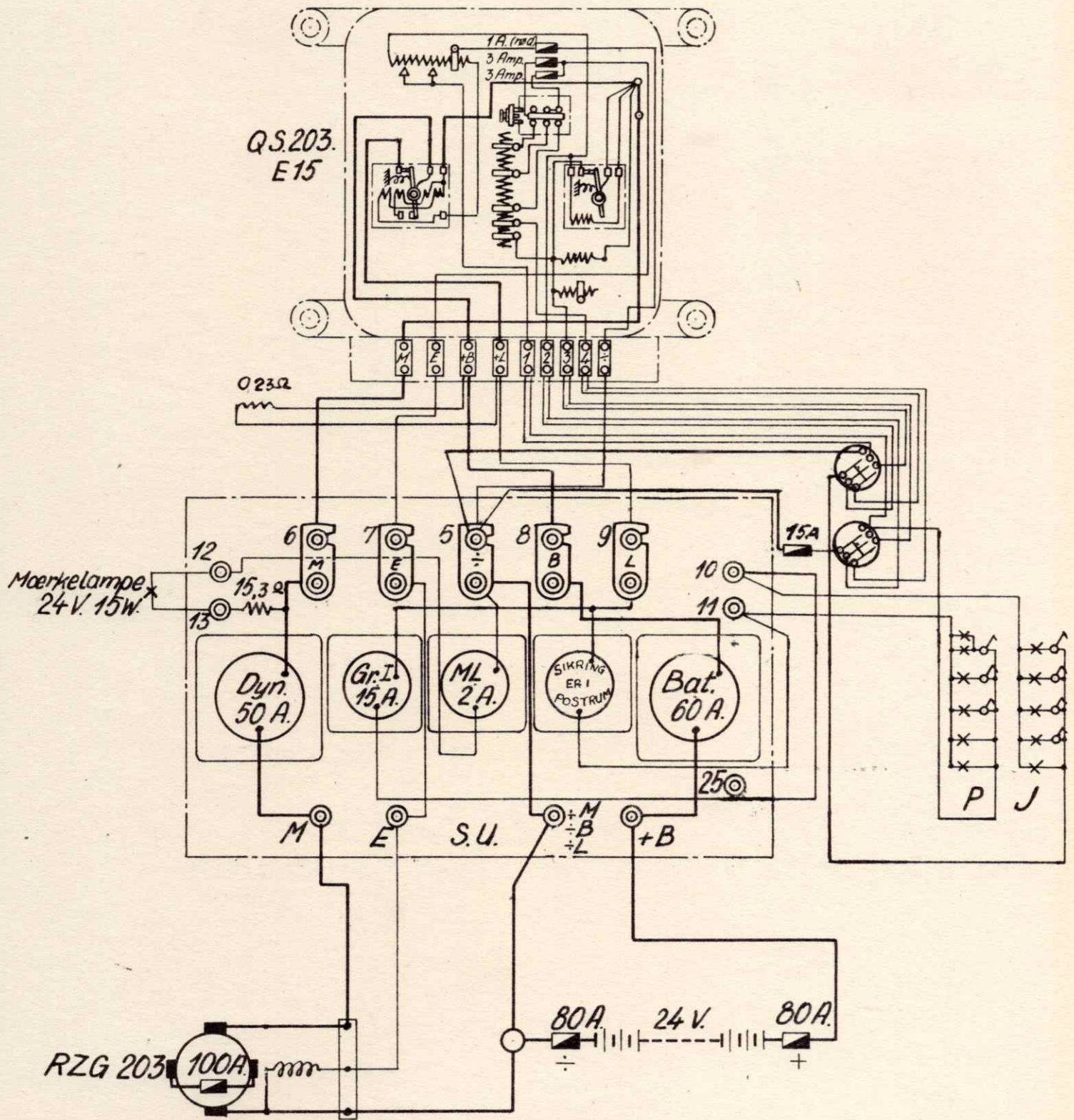

Chefen for Maskinafdelingen

L.D. Nr. 66.

Rosenberg Dynamoanlæg 12 Volt i Vogn Ltr. ^{Fi} _{Fd} Nr. ⁴⁷⁰² ₄₈₀₁₋₀₈

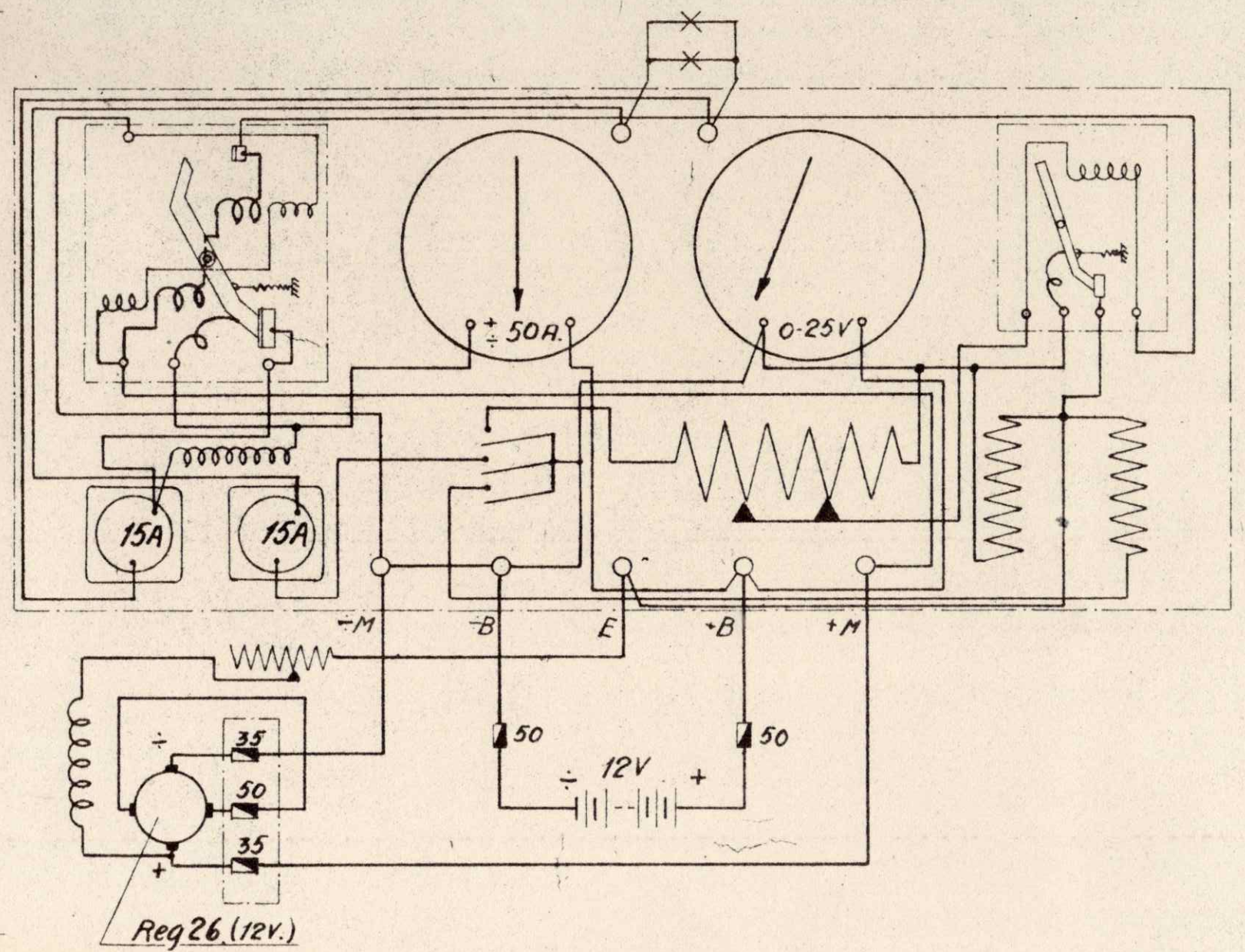

Chefen for Maskinafdelingen.

L.D. Nr. 67.

Rosenberg Dynamoanlæg 12 Volt.

Vogn Ltr. FD Nr. 4809-11

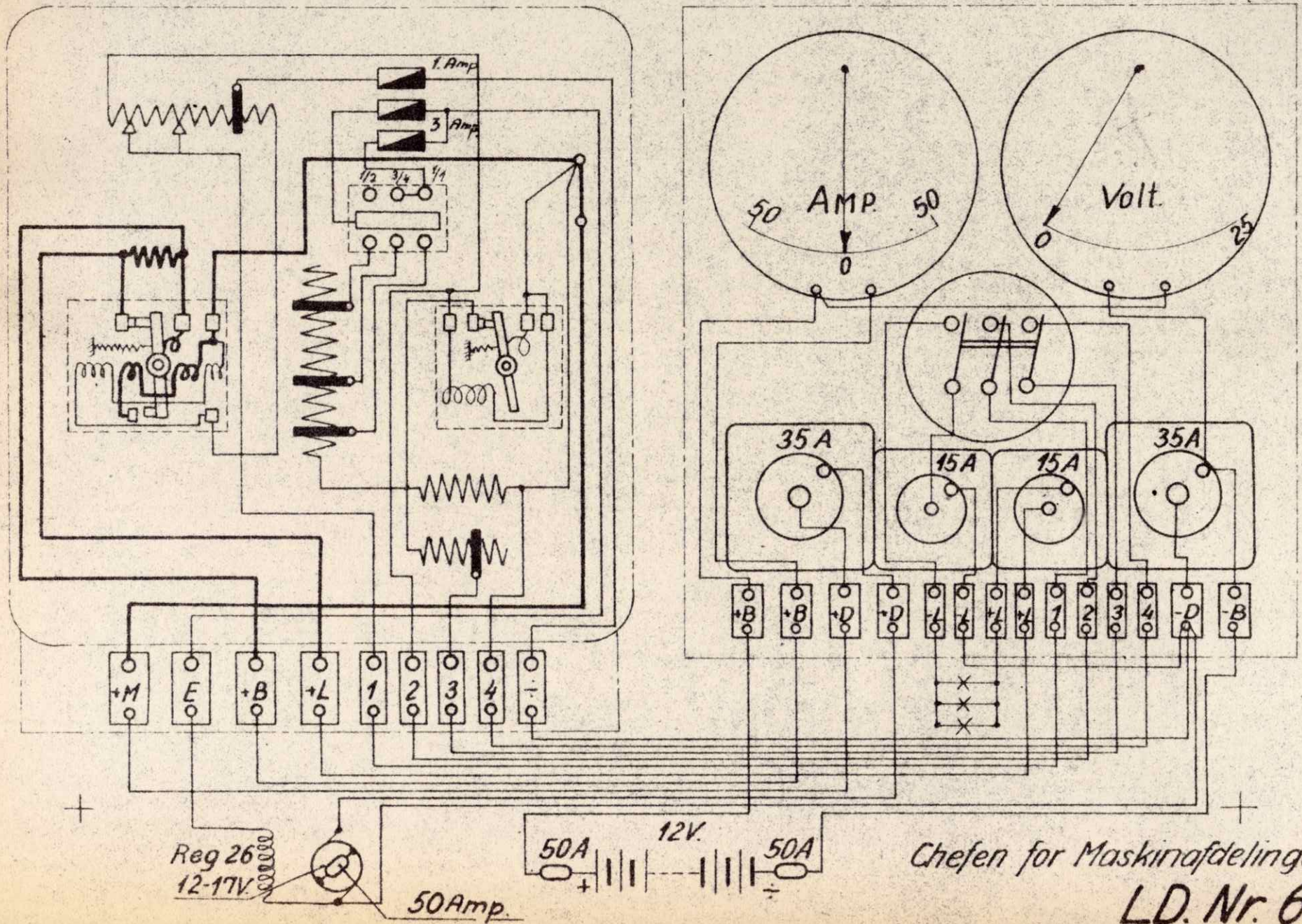

Chefen for Maskinafdelingen.

LD. Nr. 68.

Pintsch Dynamo.

Vogn Ltr. CSS Nr. 3076,18
CTH 3165

54^I WK.

Tavle Nr. 2.

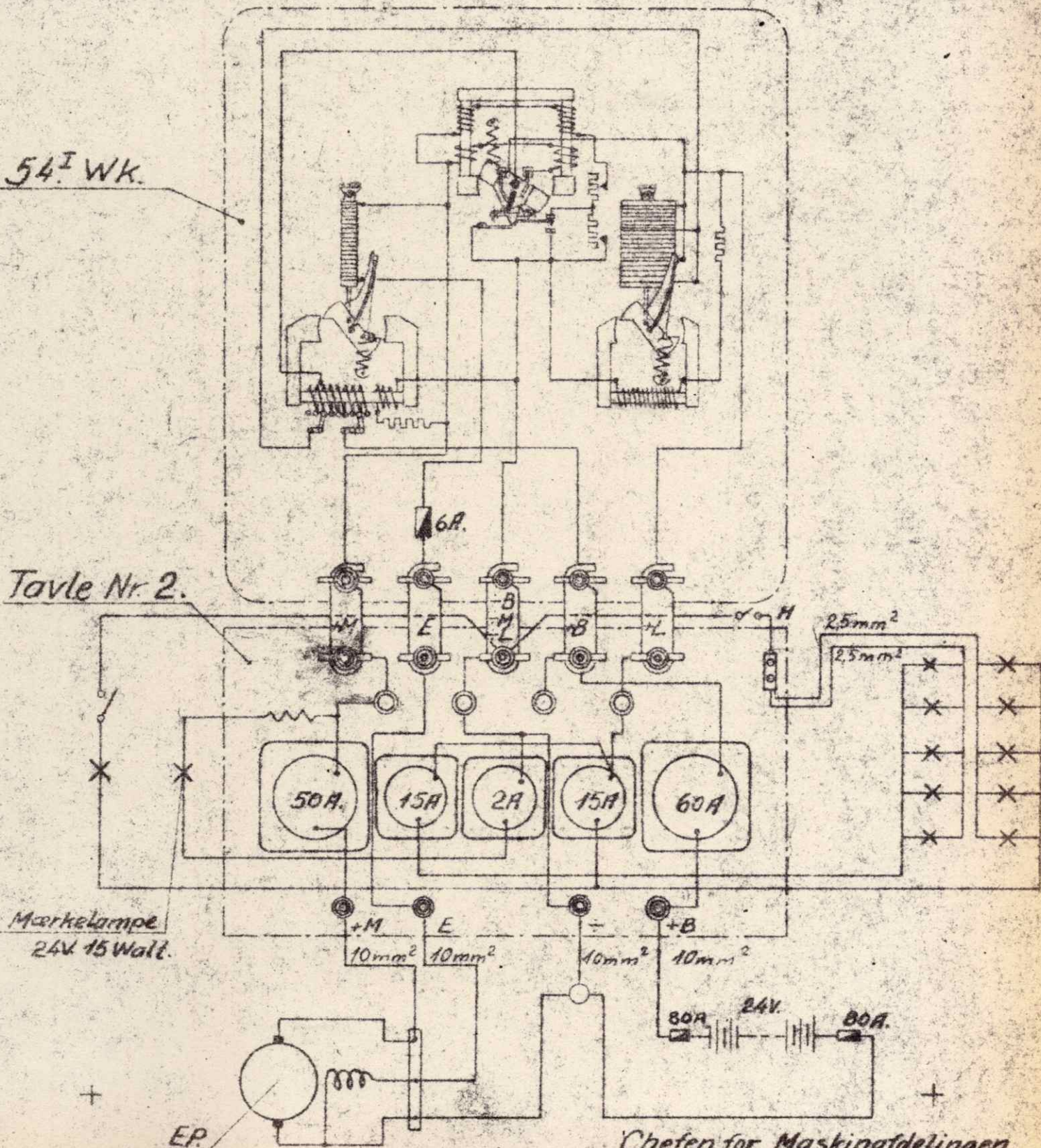

Mærkelampe
24V 15Watt.

EP.

Chefen for Maskinafdelingen.

L.D.Nr. 69

Pintsch-Dynamo

Vogn ltr. ^{CM} ²²⁰⁵ nr. ^{CHK} 2459, 75-78, 92, 95, 97

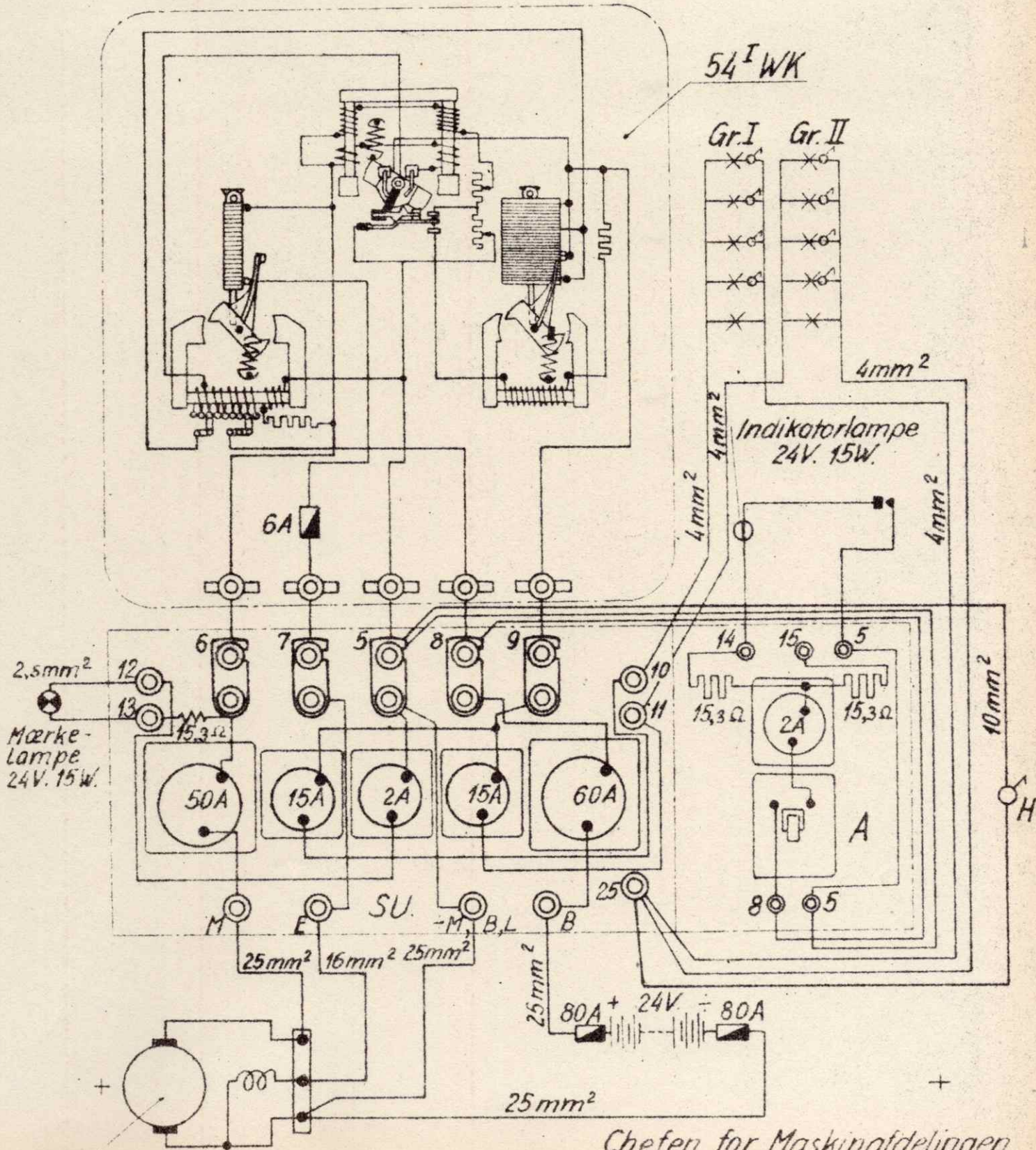

Chefen for Maskinafdelingen.

(Erstattes efterhånden med 4096.) LD. 70.

Rosenberg Dynamoanlæg.

Vogn Litra Nr.

Fc 37-42
Fv 285-292

QSL.203

D.45

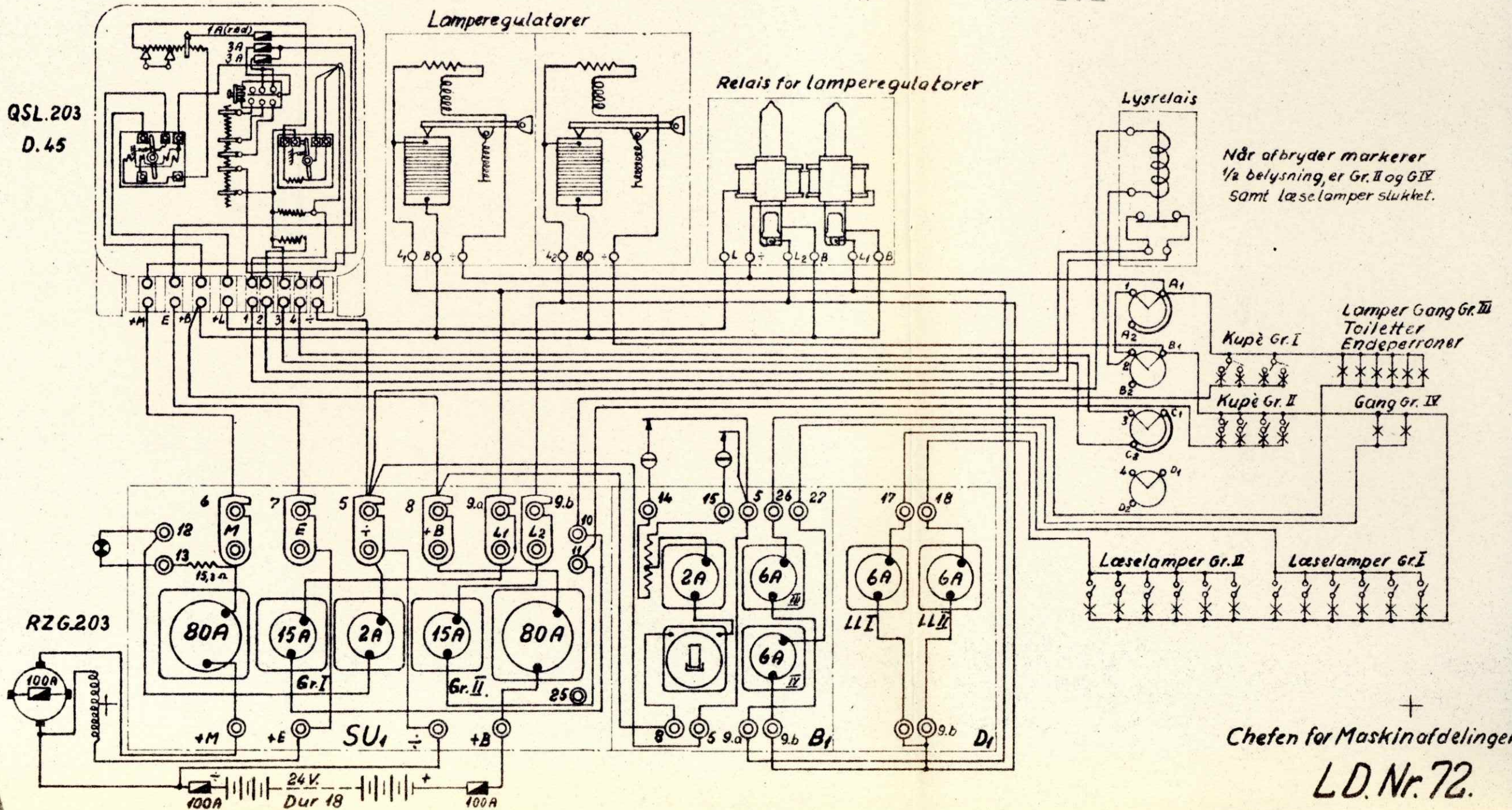

Chefen for Maskinafdelingen

L.D. Nr. 72.

Rosenberg Dynamoanlæg.

Vogn Litra _____ Nr. Som LD 72
efter ændr.

+ Overspændingsautomat

Lamperegulatorer

Relais for lamperegulatorer

Lysrelais

Når afbryder markerer
1/2 belysning, er Gr. II og Gr. IV
samt læselamper slukket.

QSL.203
D.45

RZG.203

Læselamper Gr. II

Læselamper Gr. I

+
Chefen for Maskinafdelingen.

LD. nr. 72A.

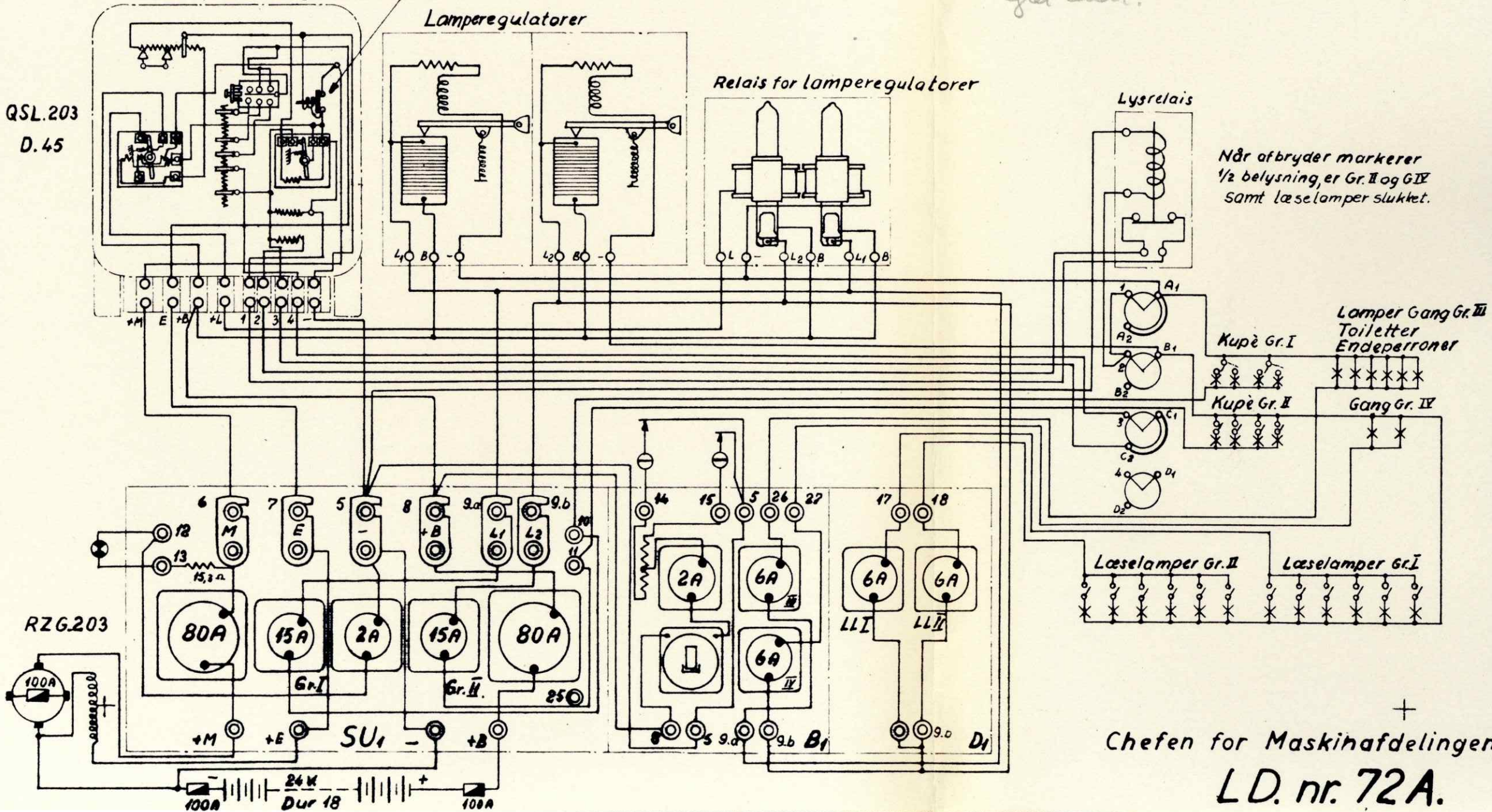

Rosenberg Dynamoanlæg.

Vogn Ltr. _____ Nr. _____

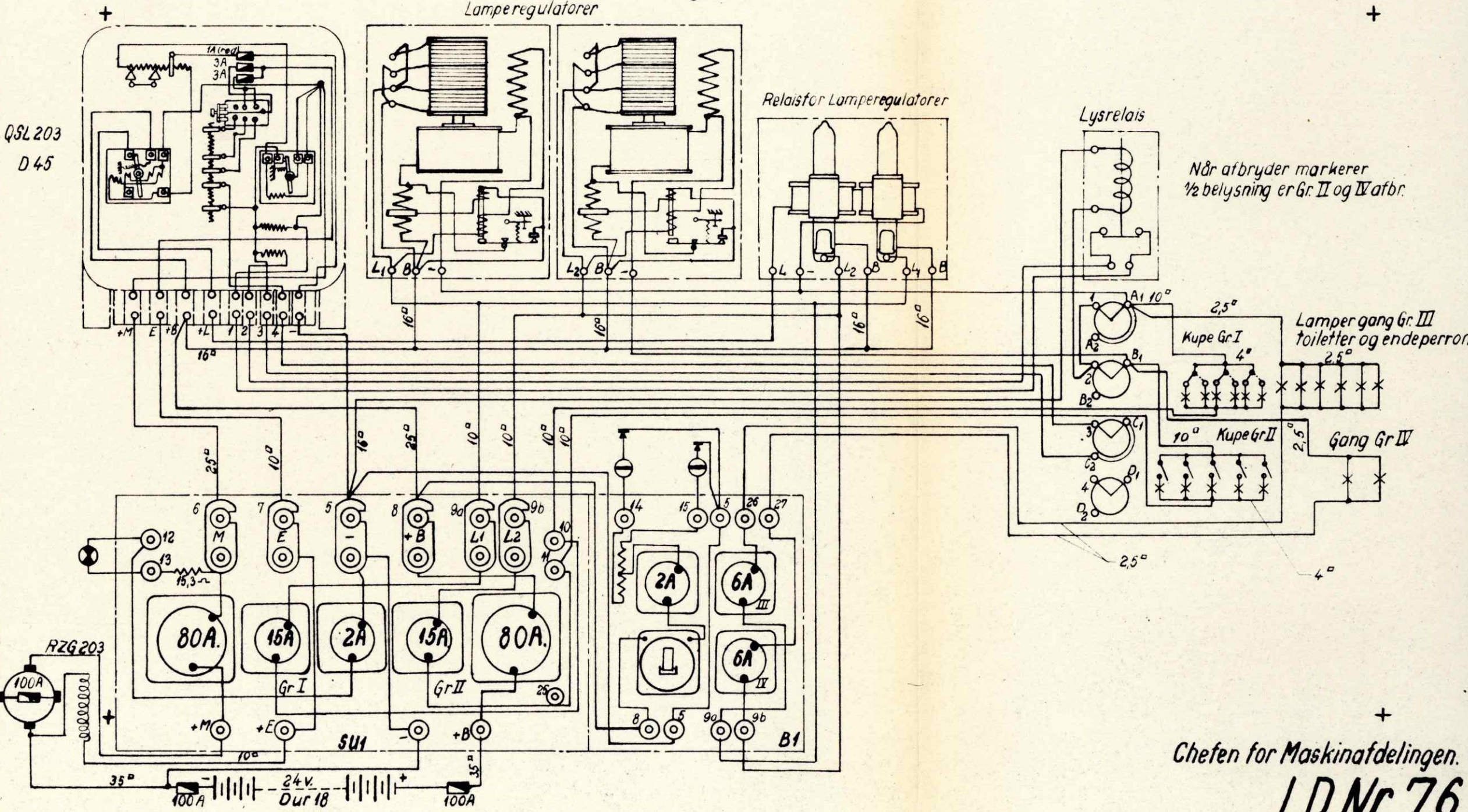

QSL 203
D 45

Chefen for Maskinafdelingen.
LD. Nr. 76.

Stone Tonum dynamo.

Ltr. Ay. Nr.

Lampemodstand.

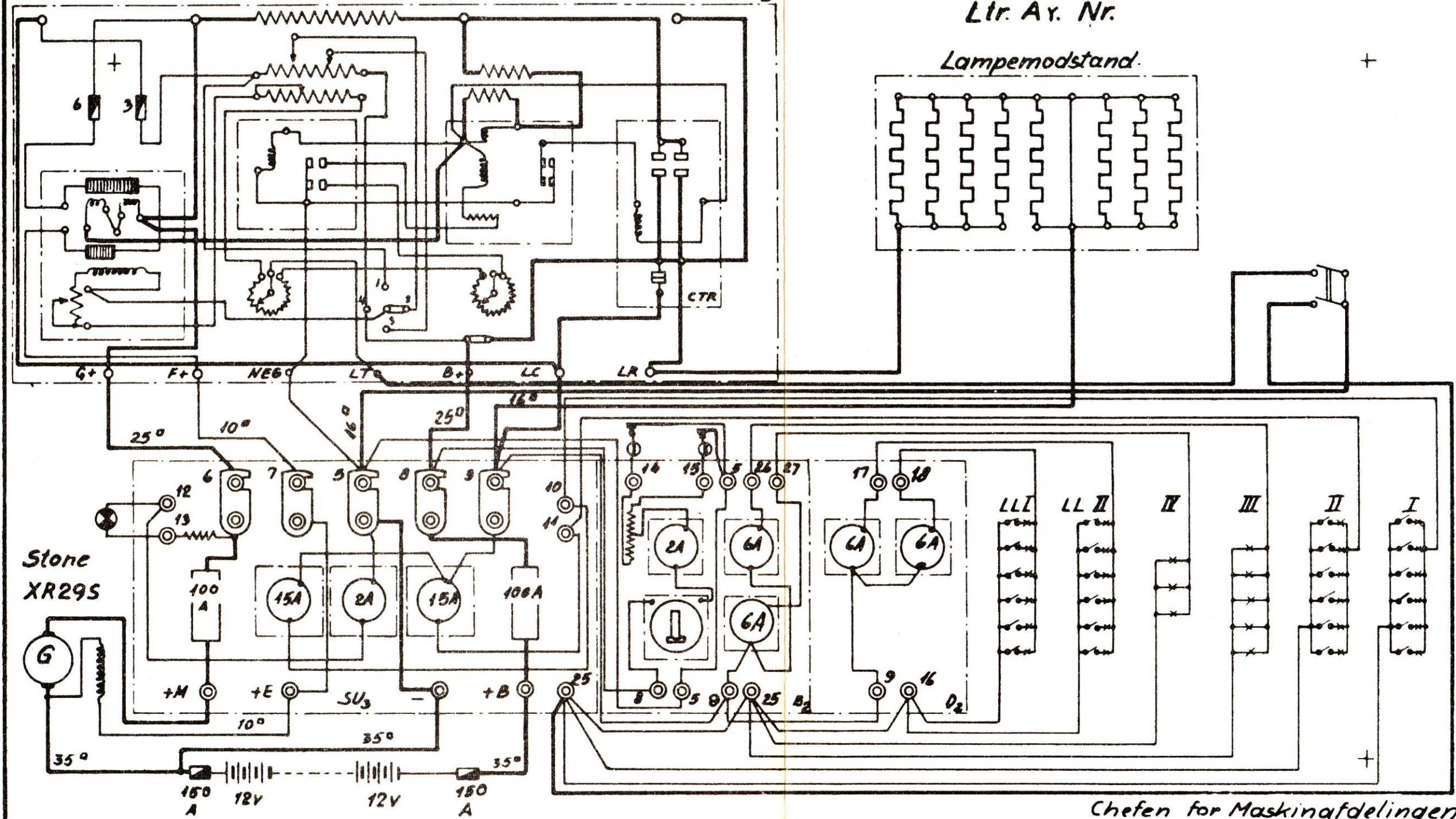

Chefen for Maskinafdelingen.
LD. Nr. 78.

Rosenberg Dynamoanlæg.

Vogn ltr. C17 nr. 1026-32

Lamperegulatorer.

Relæ for lamperegulatorer.

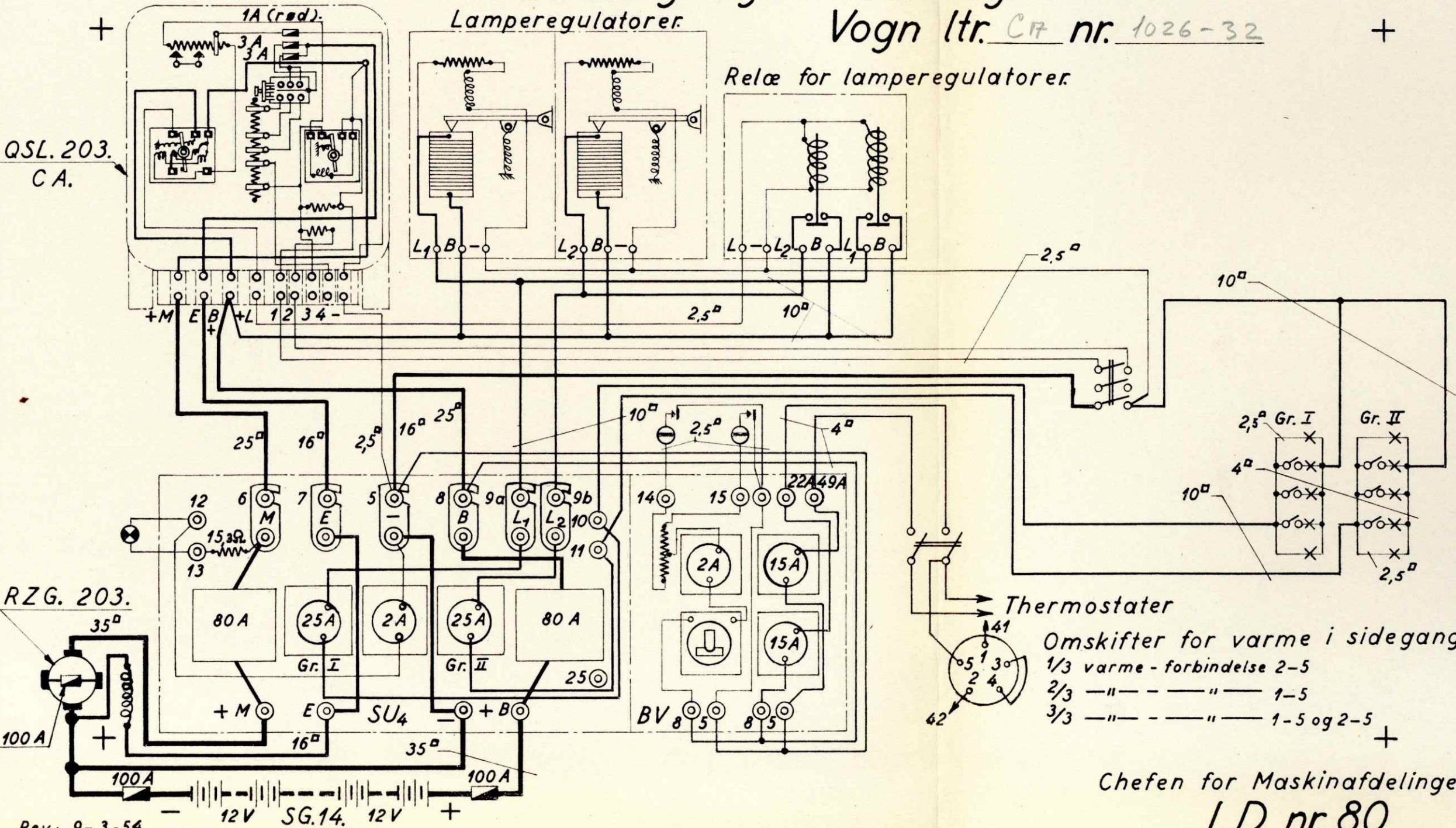

Thermostater
 Omskifter for varme i sidegang
 1/3 varme - forbindelse 2-5
 2/3 " " " " 1-5
 3/3 " " " " 1-5 og 2-5

Chefen for Maskinafdelingen.
 L.D. nr. 80.

Rev.: 9.-3.-54.

Rosenberg Dynamoanlæg.

Lamperegulatorer.

Vogn ltr. nr. 90m LD 80

(efter ændr.)

Relæ for lamperegulatorer.

QSL. 203.
CA.

RZG. 203.
35^a

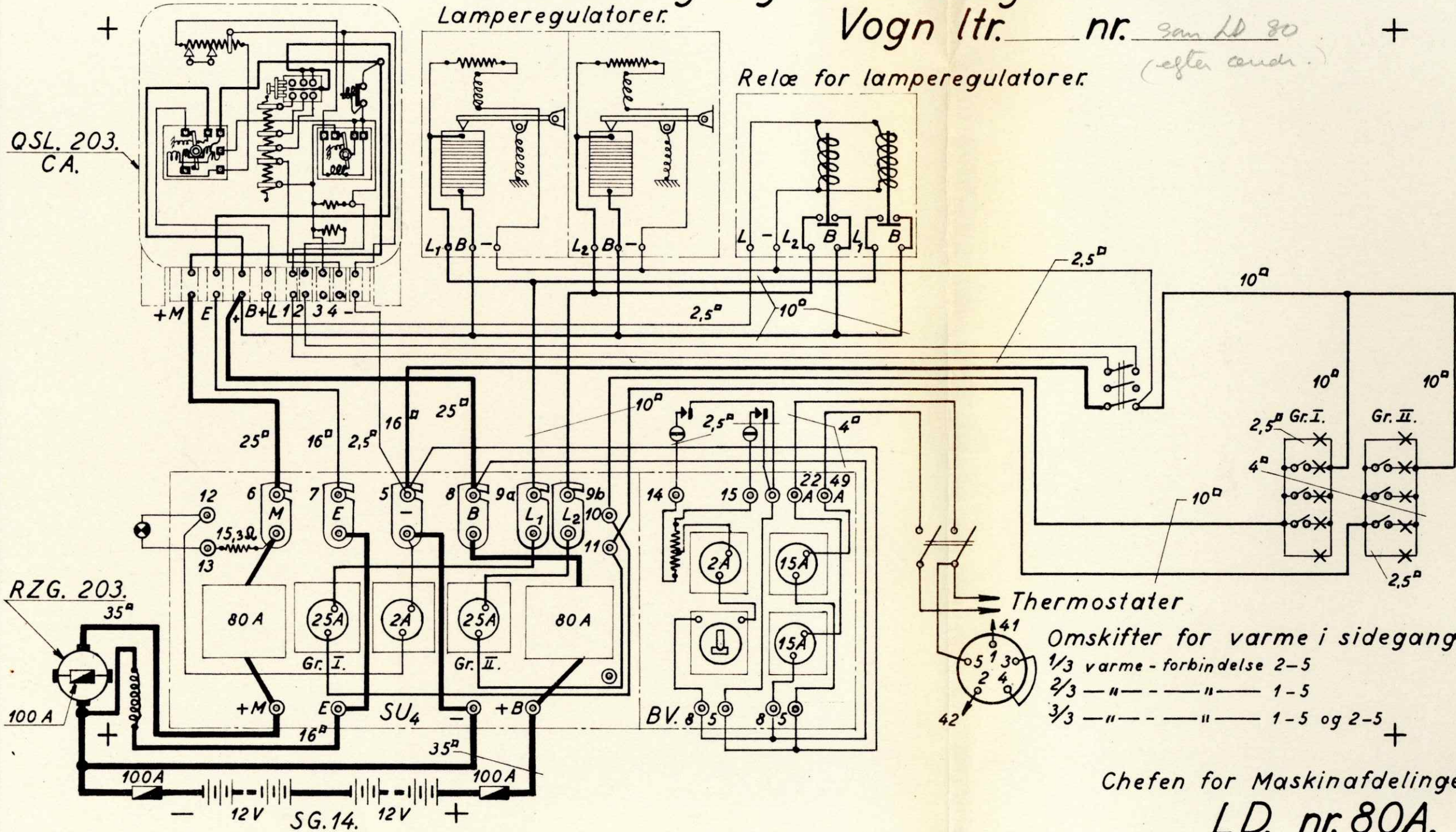

Thermostater

Omskifter for varme i sidegang
 1/3 varme-forbindelse 2-5
 2/3 " " " 1-5
 3/3 " " " 1-5 og 2-5

Chefen for Maskinafdelingen.
 LD. nr. 80A.

Thrige-Dick Dynamoanlæg.

Vogn Ltr. CF. Nr. 1001, 02, 04, 05, 07

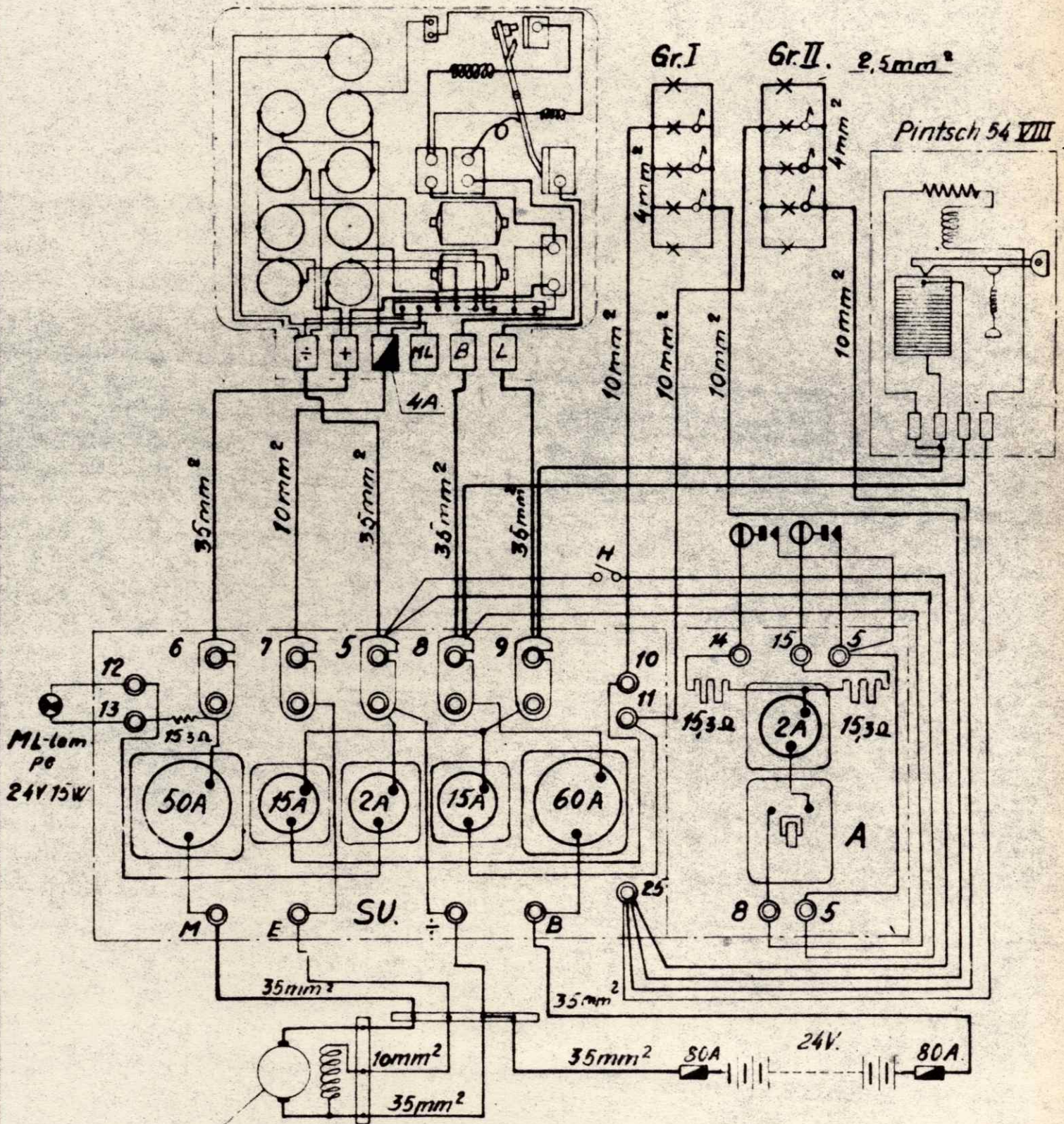

CF. 12

Chefen for Maskinafdelingen.

LD. Nr. 81

Rosenberg Dynamoanlæg.

Vogn Ltr. EA Nr. 6001-12

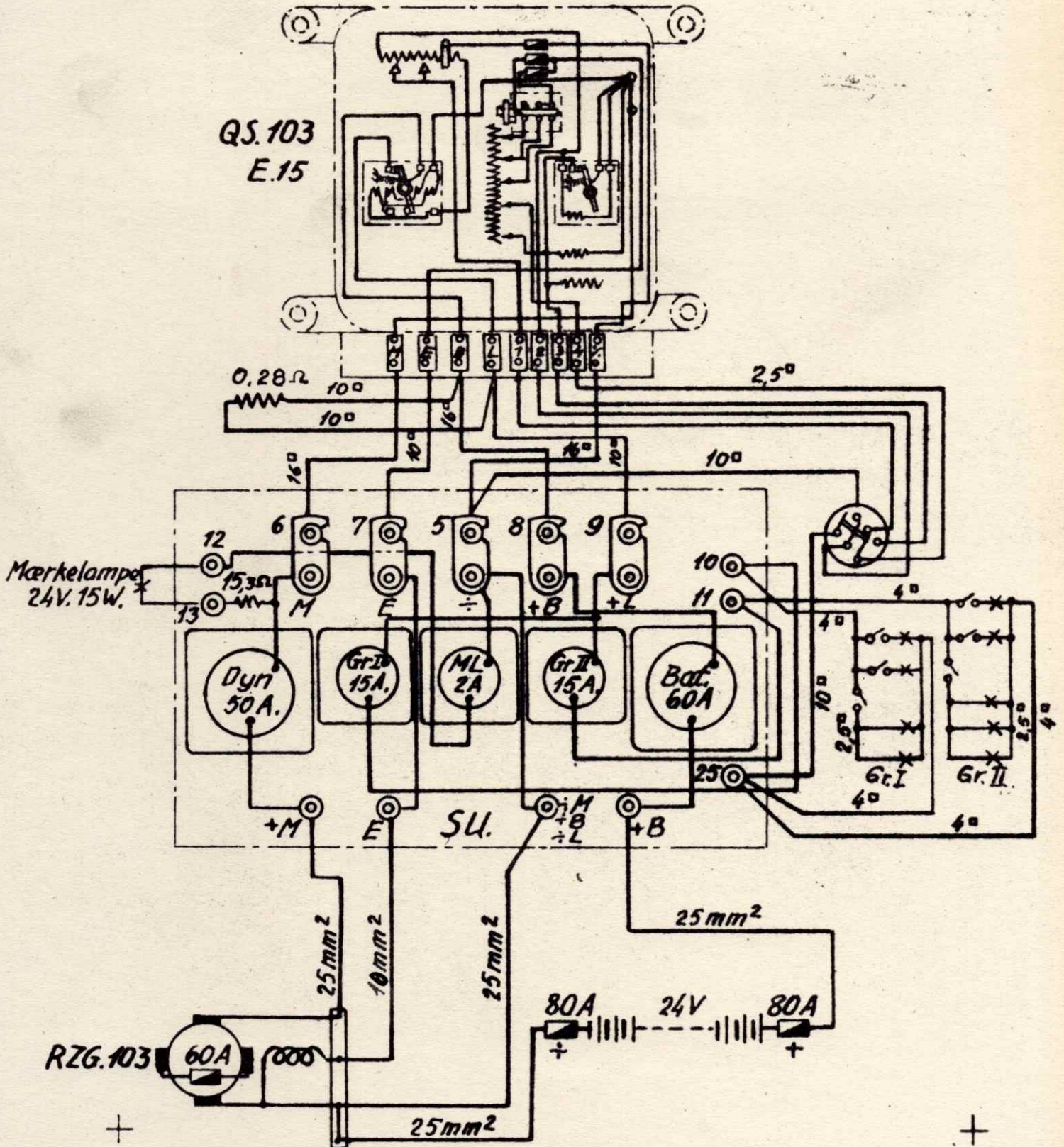

Chefen for Maskinafdelingen.

LD. Nr. 82.

Thrige-Dick Dynamoanlæg.

LD
Se endv. 23

Vogn Ltr. Hu Nr. 257-55

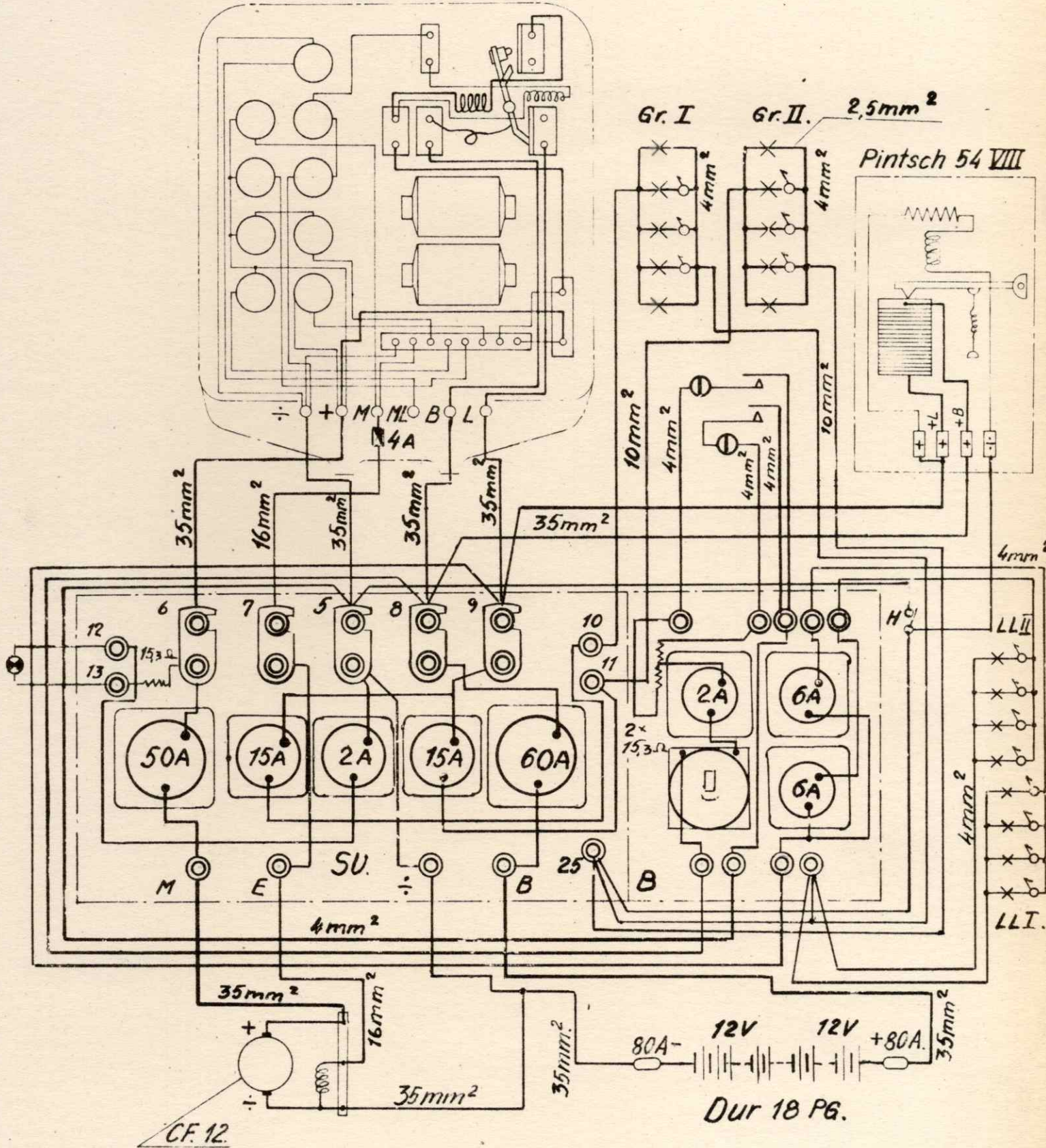

Au. 11.200-1

Rev 10-5-54

Chefen for Maskinafdelingen.
LD.Nr.83.

Pintsch-Dynamo

Vogn Ltr. Co Nr. 2543, 48, 2742, 43, 47, 61, 94

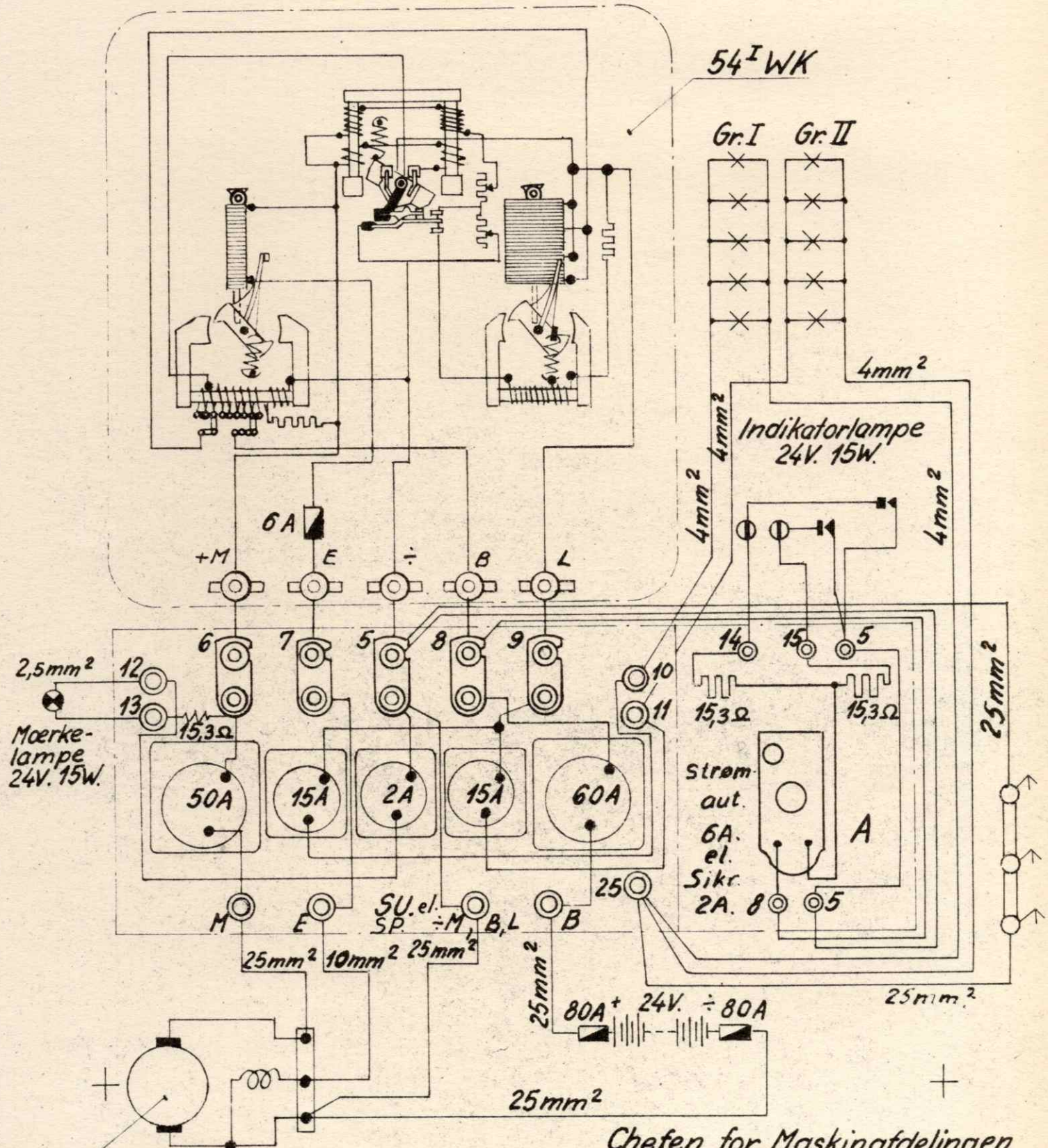

Chefen for Maskinafdelingen.

LD. 84.

Pintsch-Dynamo.

Vogn Ltr. CP Nr. 2802, 13, 16, 17, 21, 22, 27, 43, 52
 2902, 04, 12, 23, 26, 33, 35, 54
 55, 58, 61, 66, 67, 68, 71

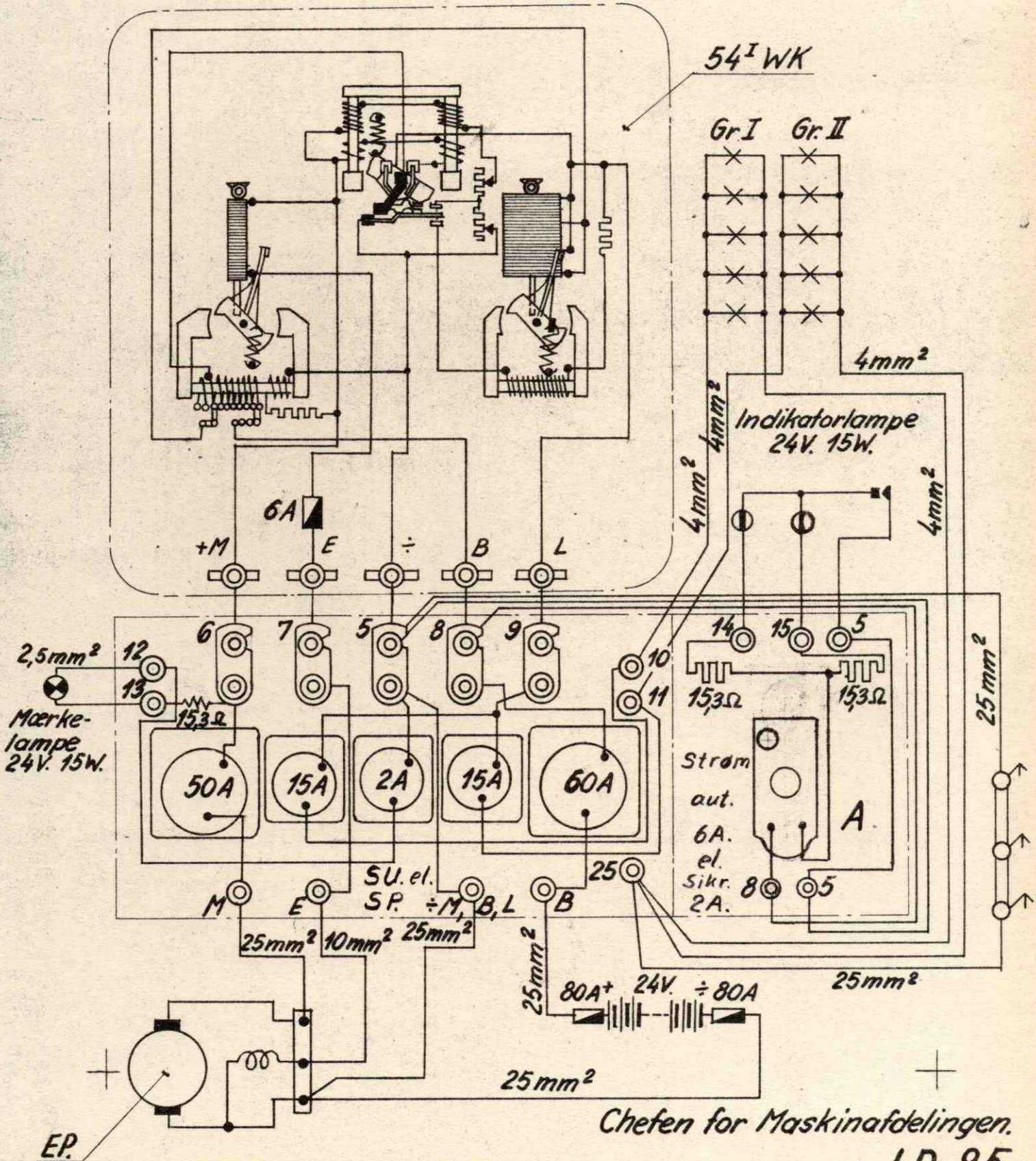

Rosenberg-Dynamoanlæg.

Vogn Ltr. CHR Nr. 2121, 2122

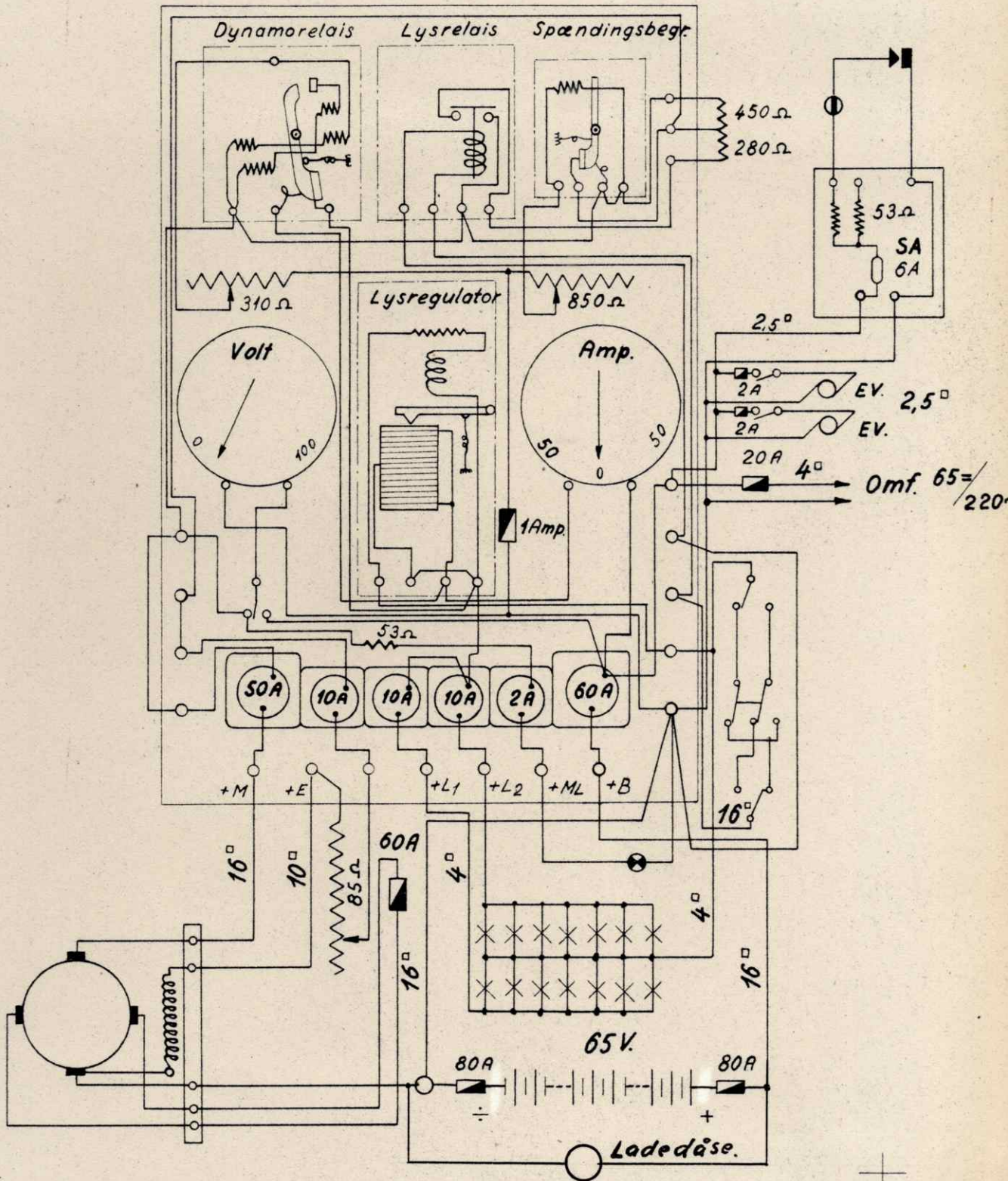

Dyn. Reg 76.
65 Volt.

Chefen for Maskinafdelingen.

LD. Nr. 86.

Pintsch-Dynamo.

Vogn Ltr. Hc Nr. 43-52

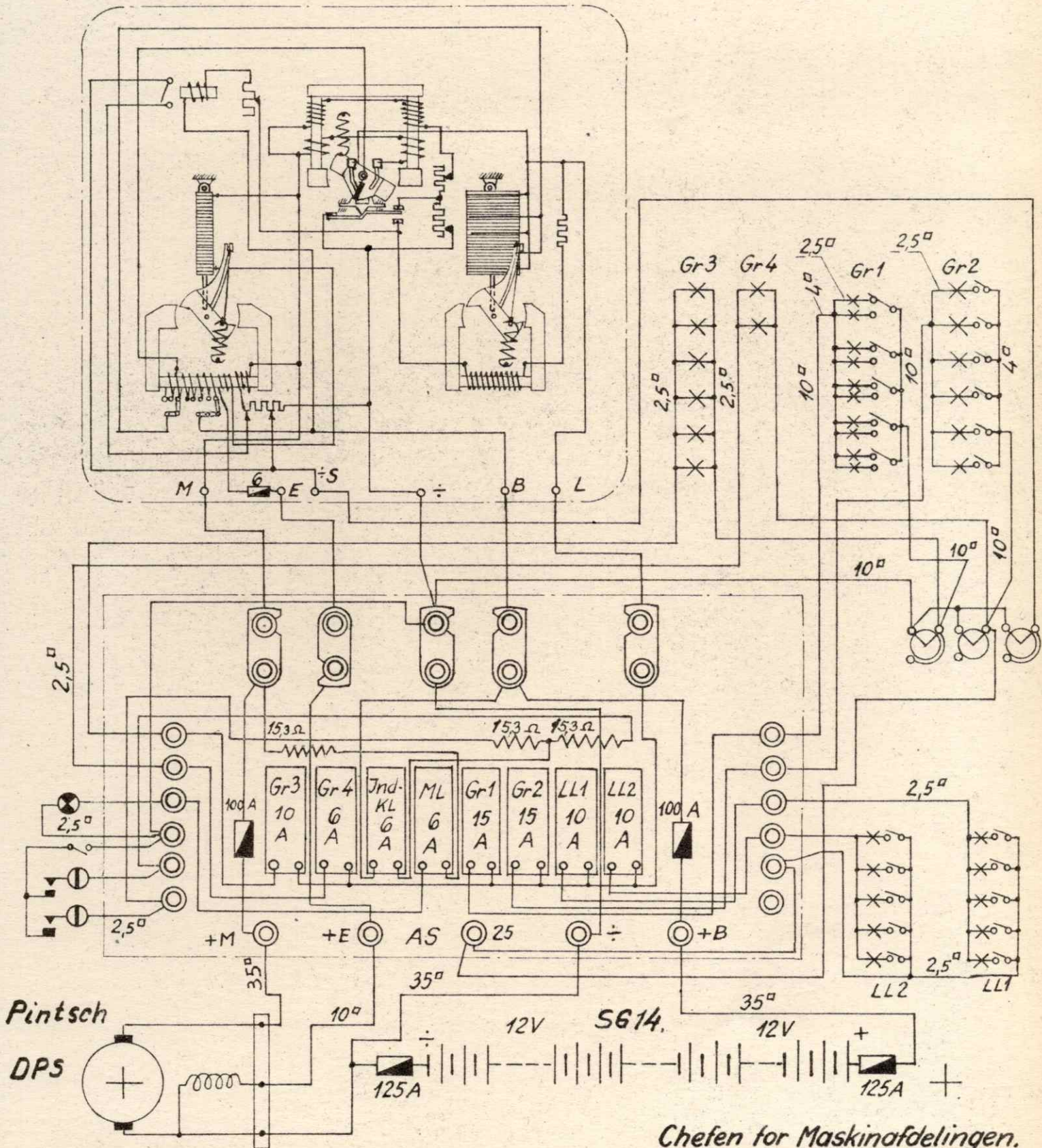

Chefen for Maskinafdelingen.

LD. Nr. 87.

G.E.Z. Dynamo.
 Vogn Ltr. Cc Nr. 1115-48

ZR 50 S

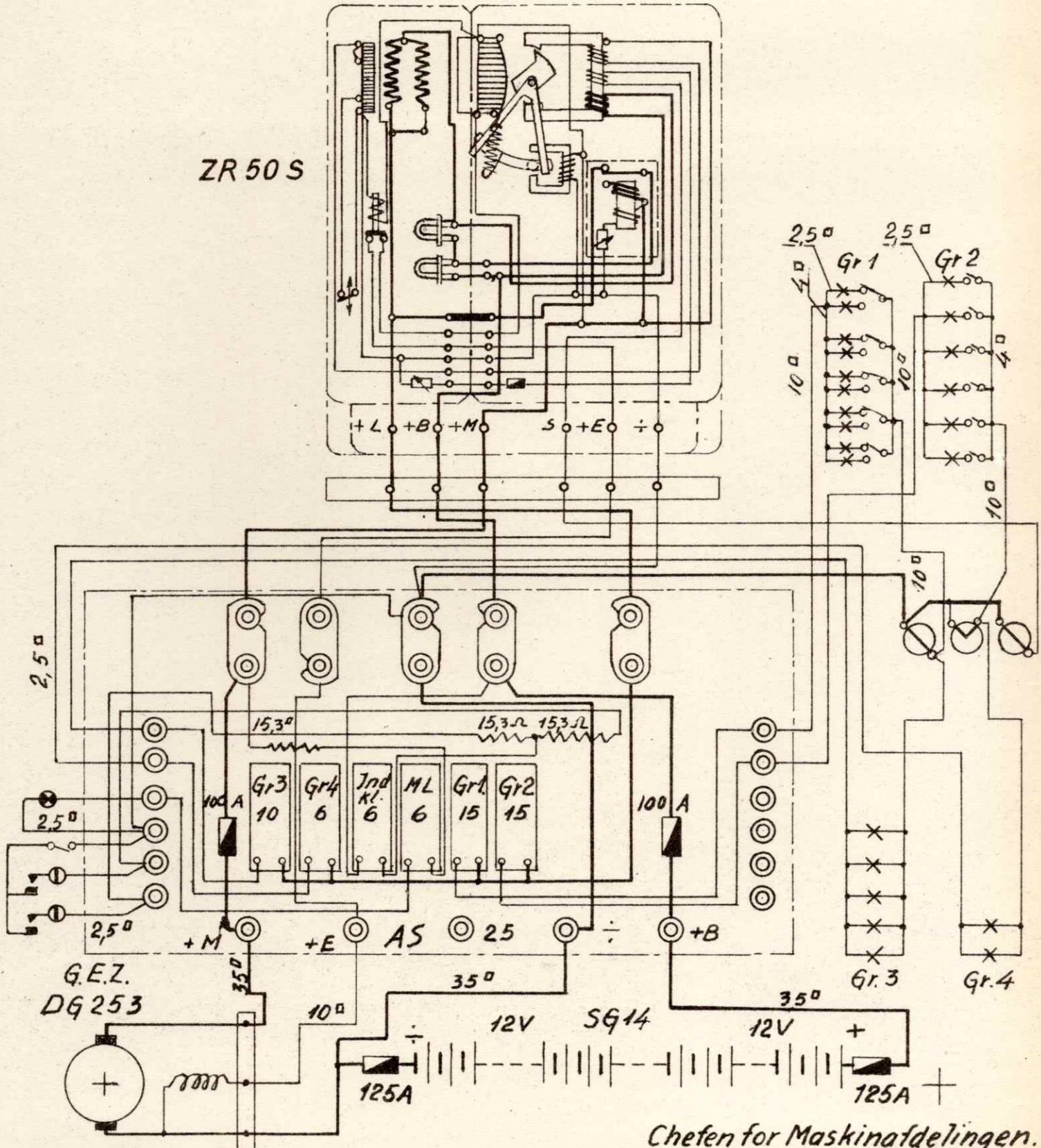

Chefen for Maskinafdelingen.
 LD.Nr. 88.

G.E.Z. Dynamo.

Vogn ltr. nr. _____

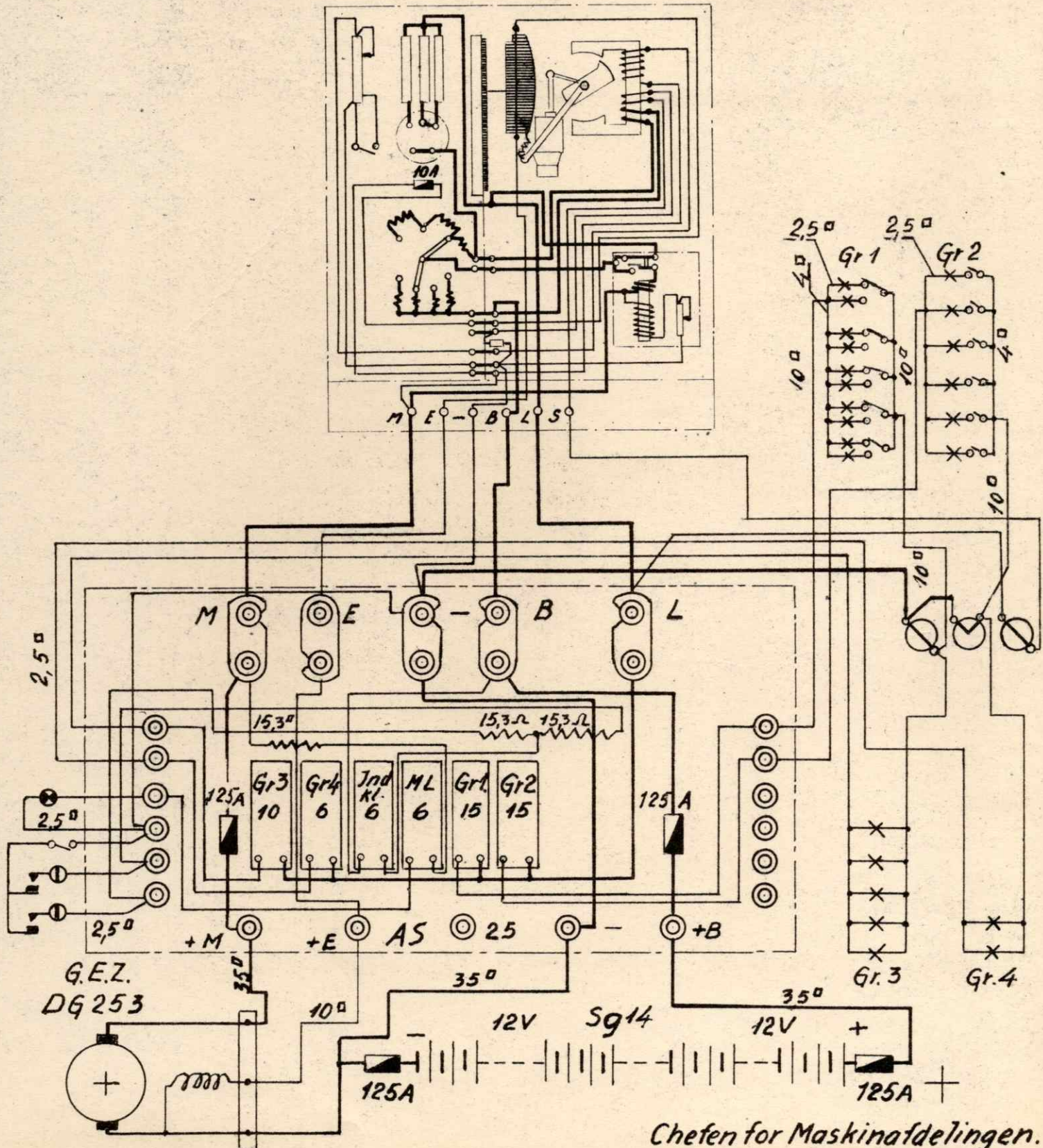

Chefen for Maskinafdelingen.
LD.Nr. 88.

se LD 64

Rosenberg Dynamoanlæg.

Vogn ltr. CL nr. 1501-1612

+

+

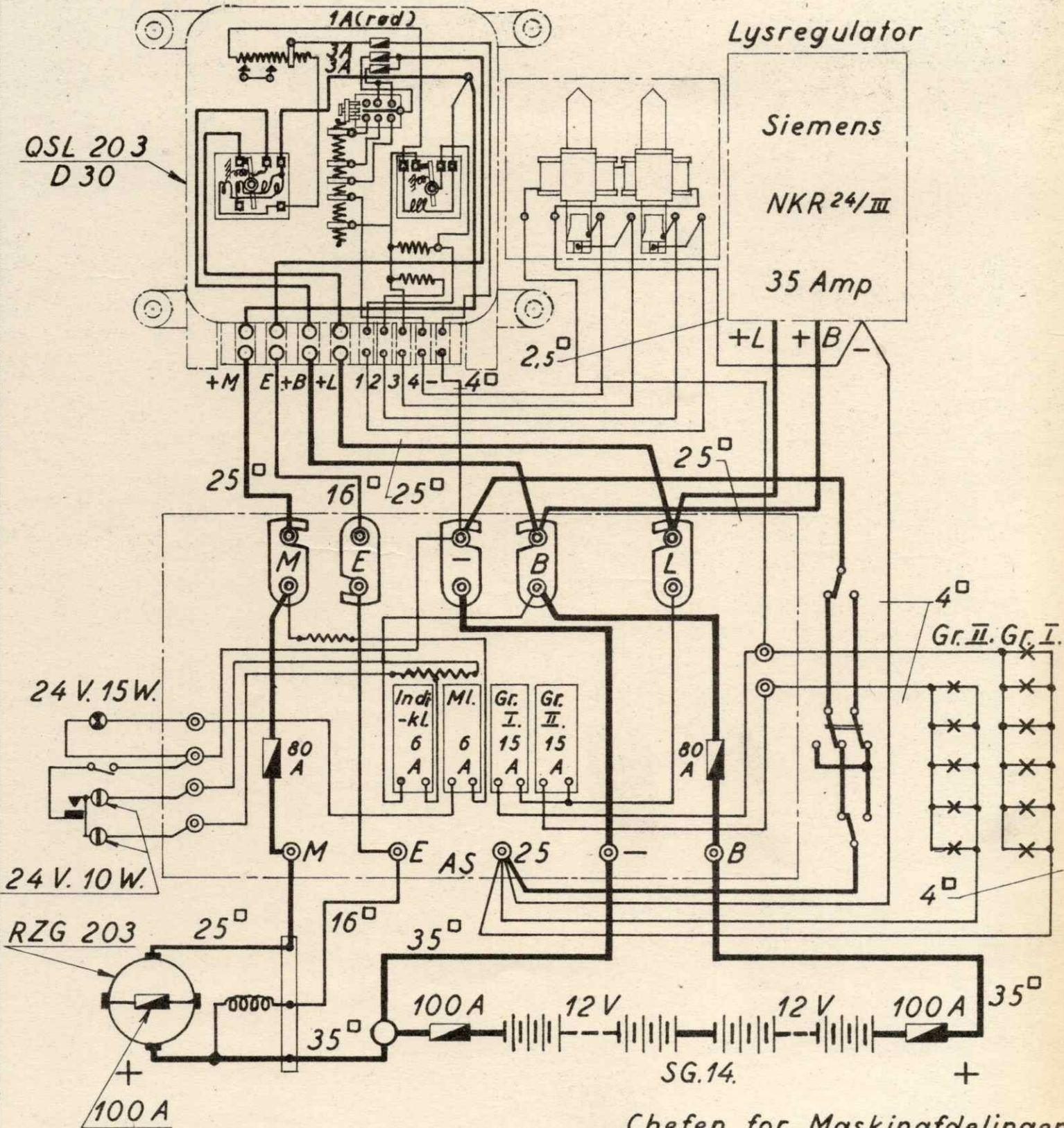

Chefen for Maskinafdelingen.

LD. nr. 89.

CL III. 11.200-1.

Rosenberg Dynamoanlæg.

Vogn ltr. CL nr. 1501-1612

+

+

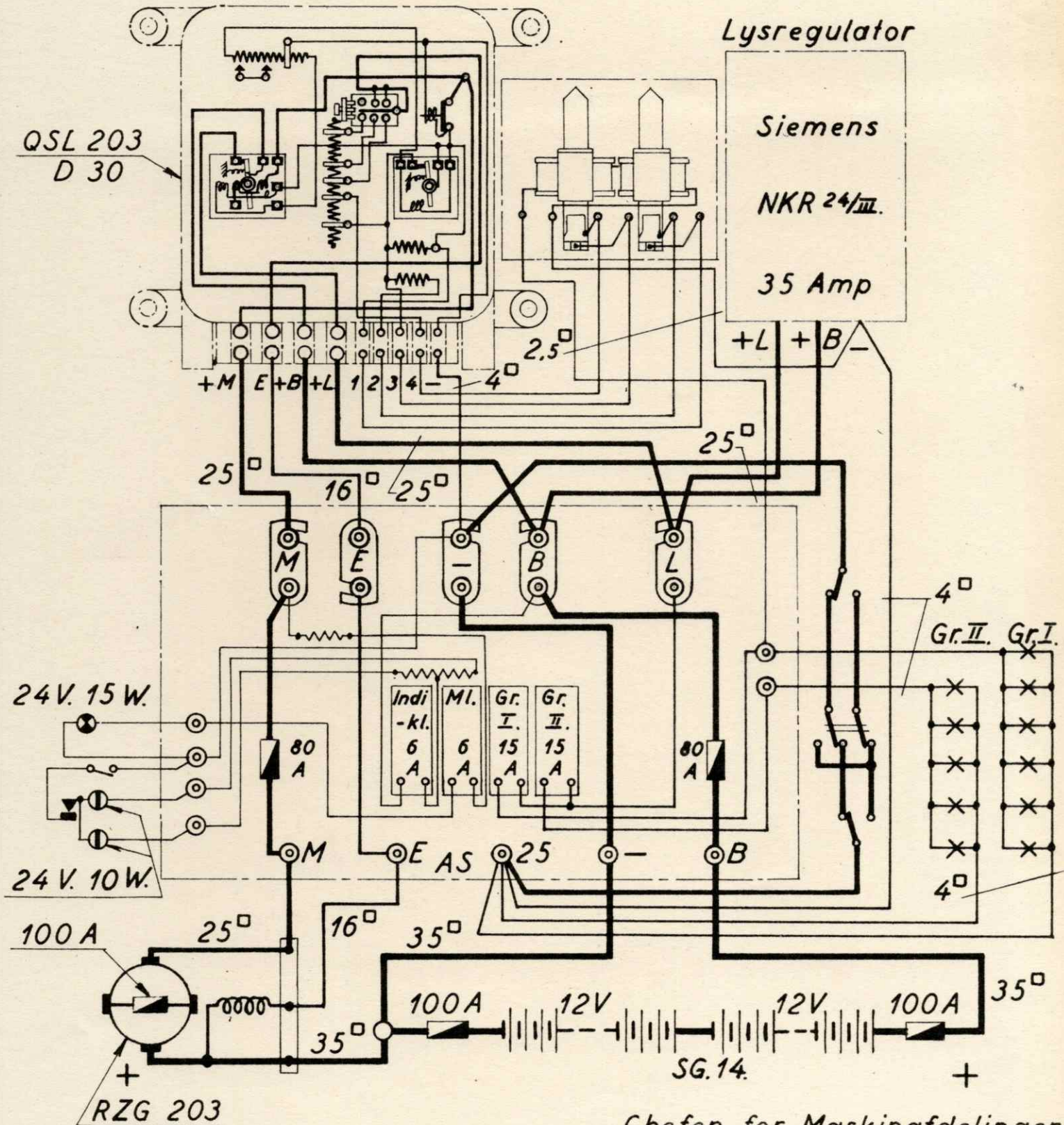

Chefen for Maskinafdelingen.
LD. nr. 89A.

Pintsch Dynamo.

Vogn Ltr. CD Nr. 1201-12

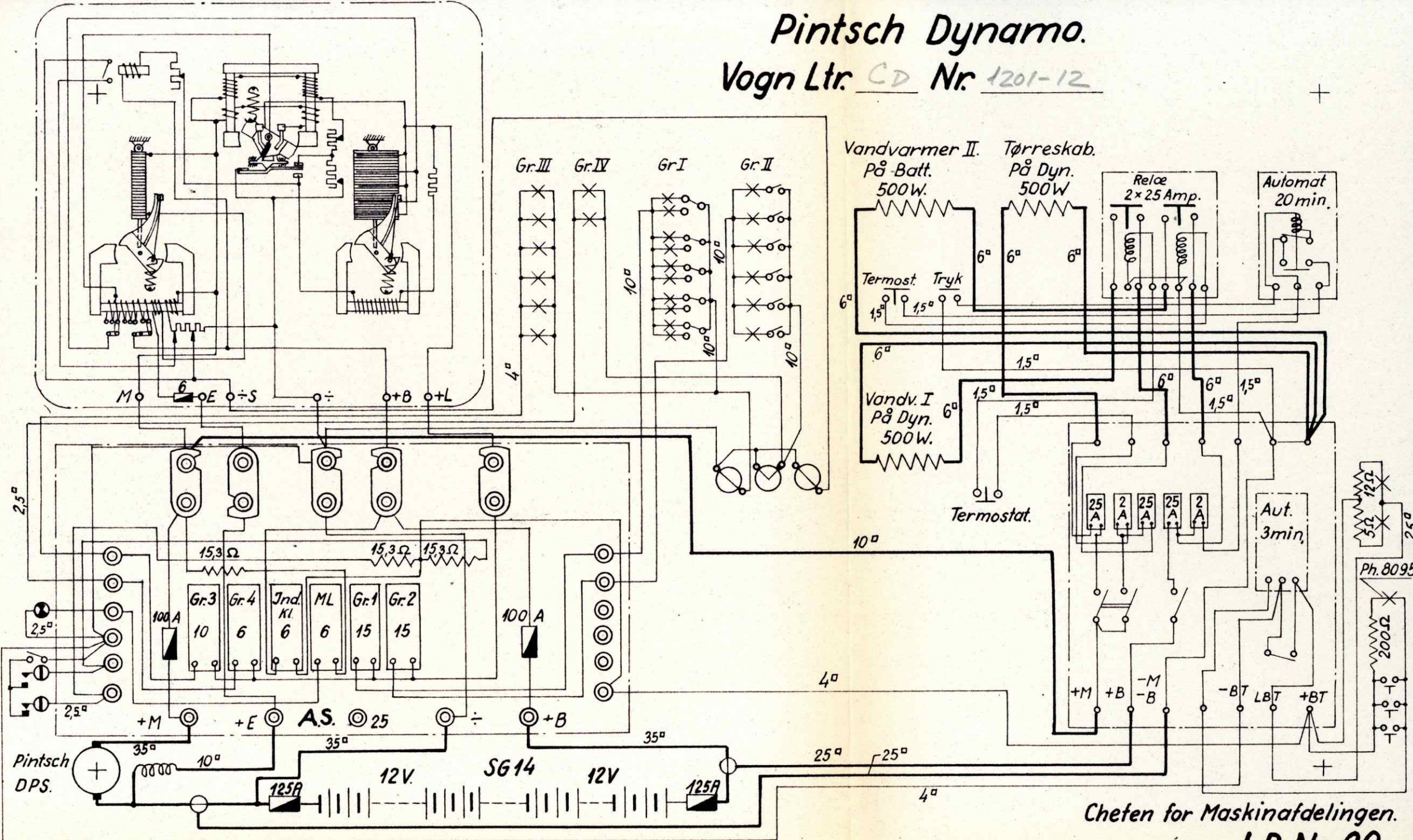

Chefen for Maskinafdelingen.
L.D. Nr. 90.

Rosenberg Dynamoanlæg.

Vogn Ltr. Ac Nr. 71, 72

QSL. 203.
E. 30.

Indstilling:
3/4.

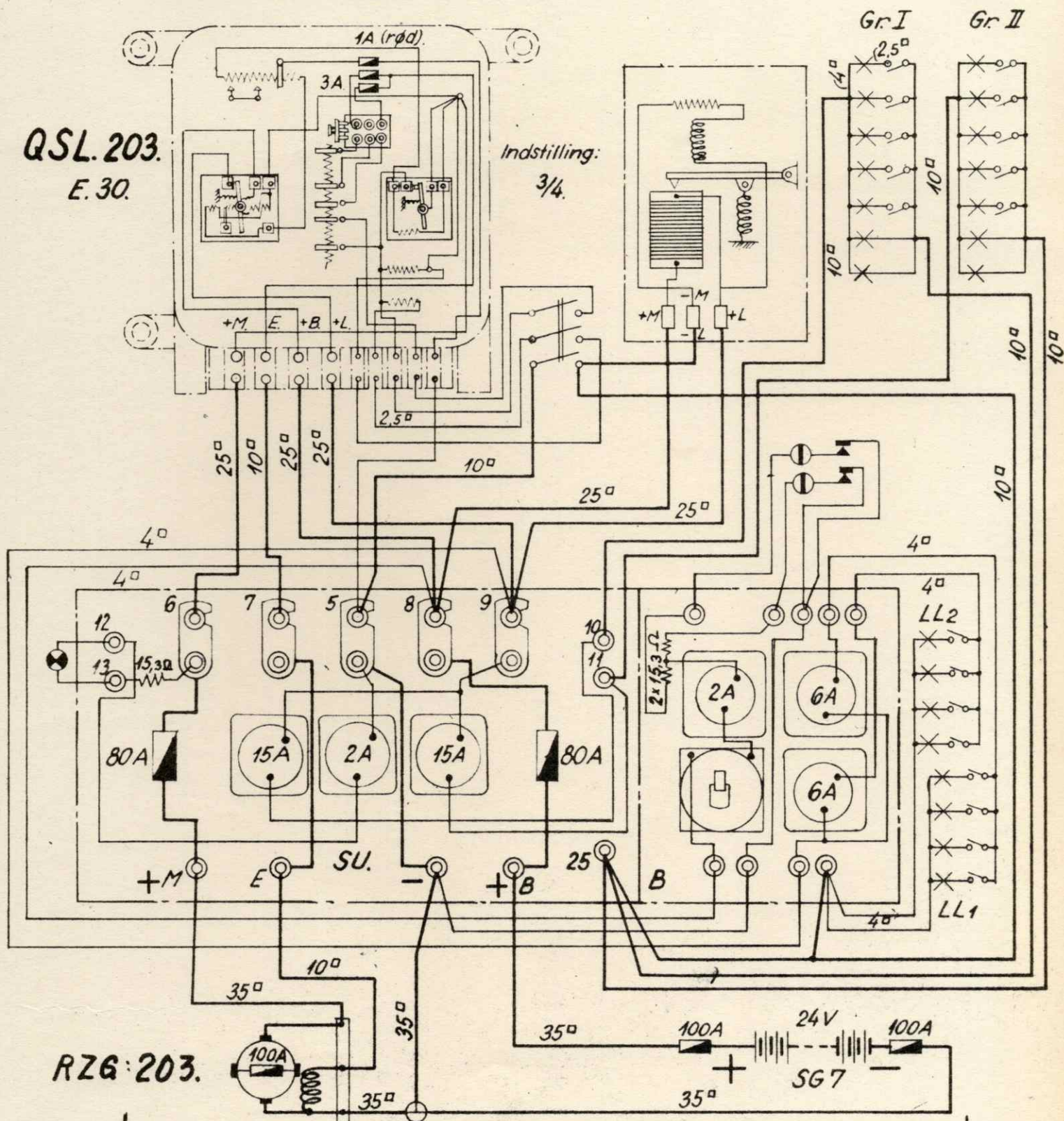

RZG: 203.

Max. Belastning: 33 Amp.

Chefen for Maskinafdelingen.

LD. Nr. 91.

Rosenberg Dynamoanlæg

Vogn Ltr. Ac Nr. 71,72

(efters ændr.)

QSL. 203.
E. 30.

Indstilling:
3/4.

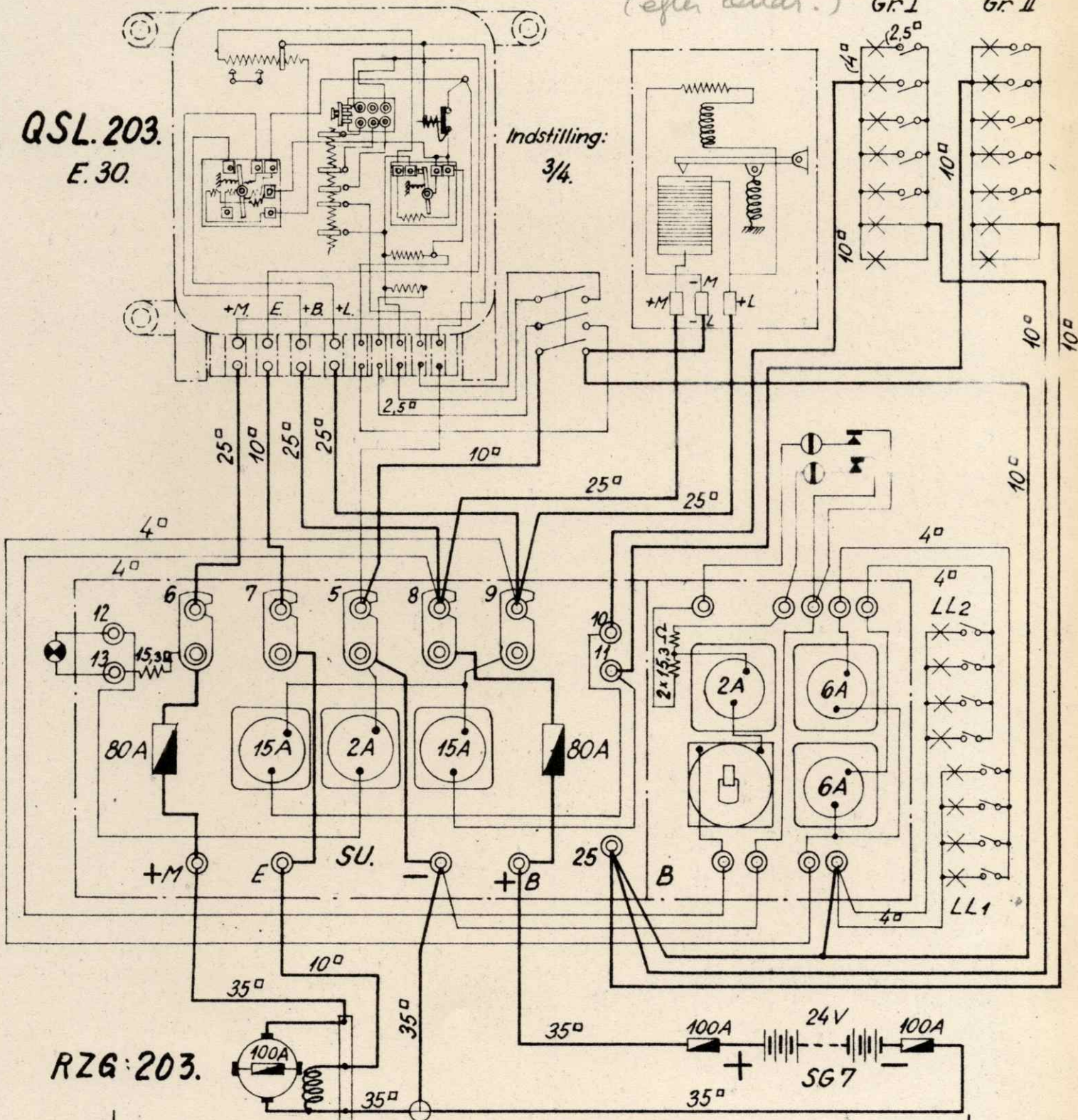

RZG: 203.

Max. Belastning: 33 Amp.

Chefen for Maskinafdelingen.

LD. Nr. 91.A.

ACM. 11.200-1.

Pintsch Dynamo.

Vogn Ltr. _____ Nr. _____

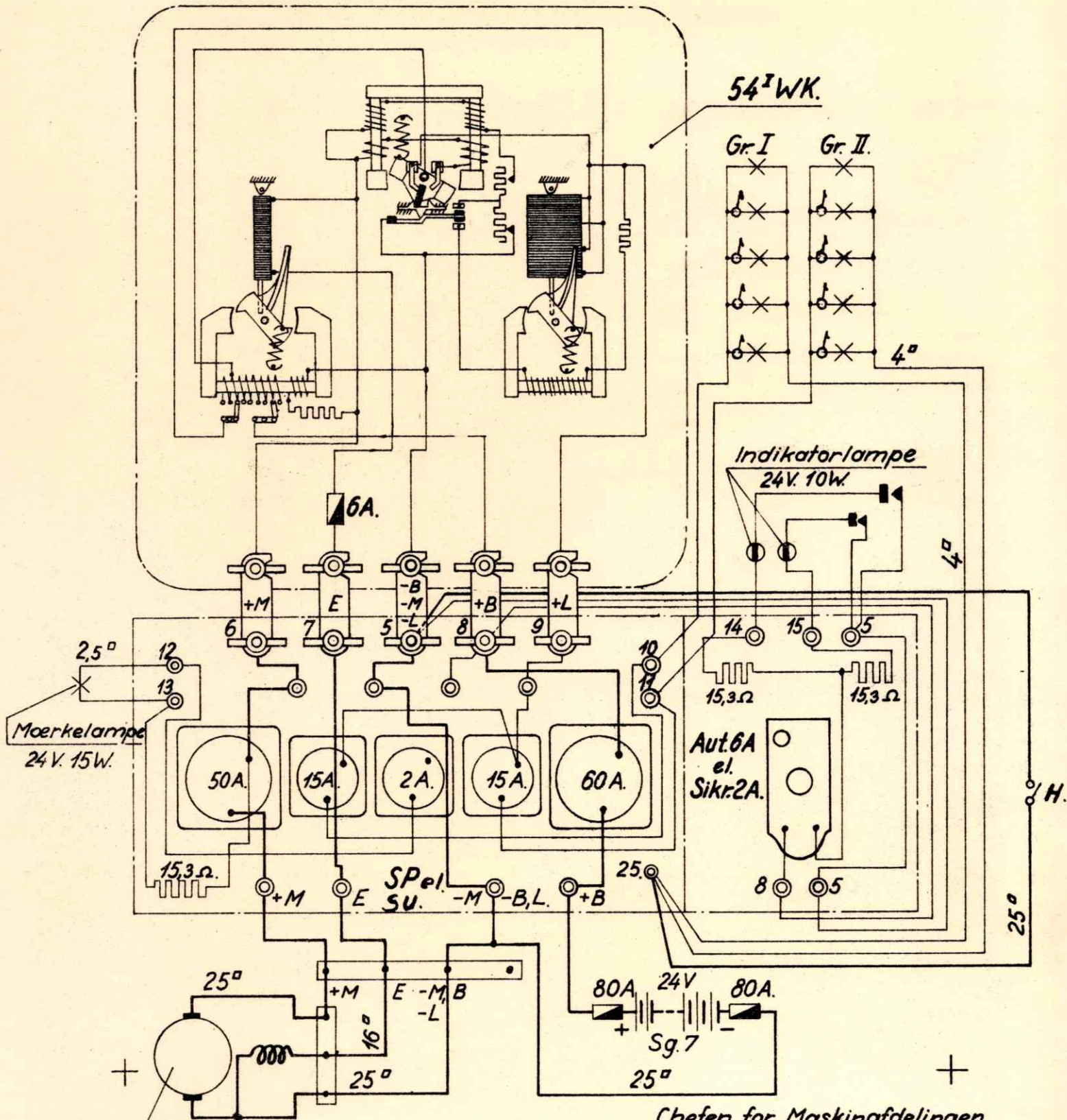

Chefen for Maskinafdelingen.

LD. Nr. 93.

Rosenberg - Dynamoanlæg.

Vogn Ltr. CMR Nr. 2123

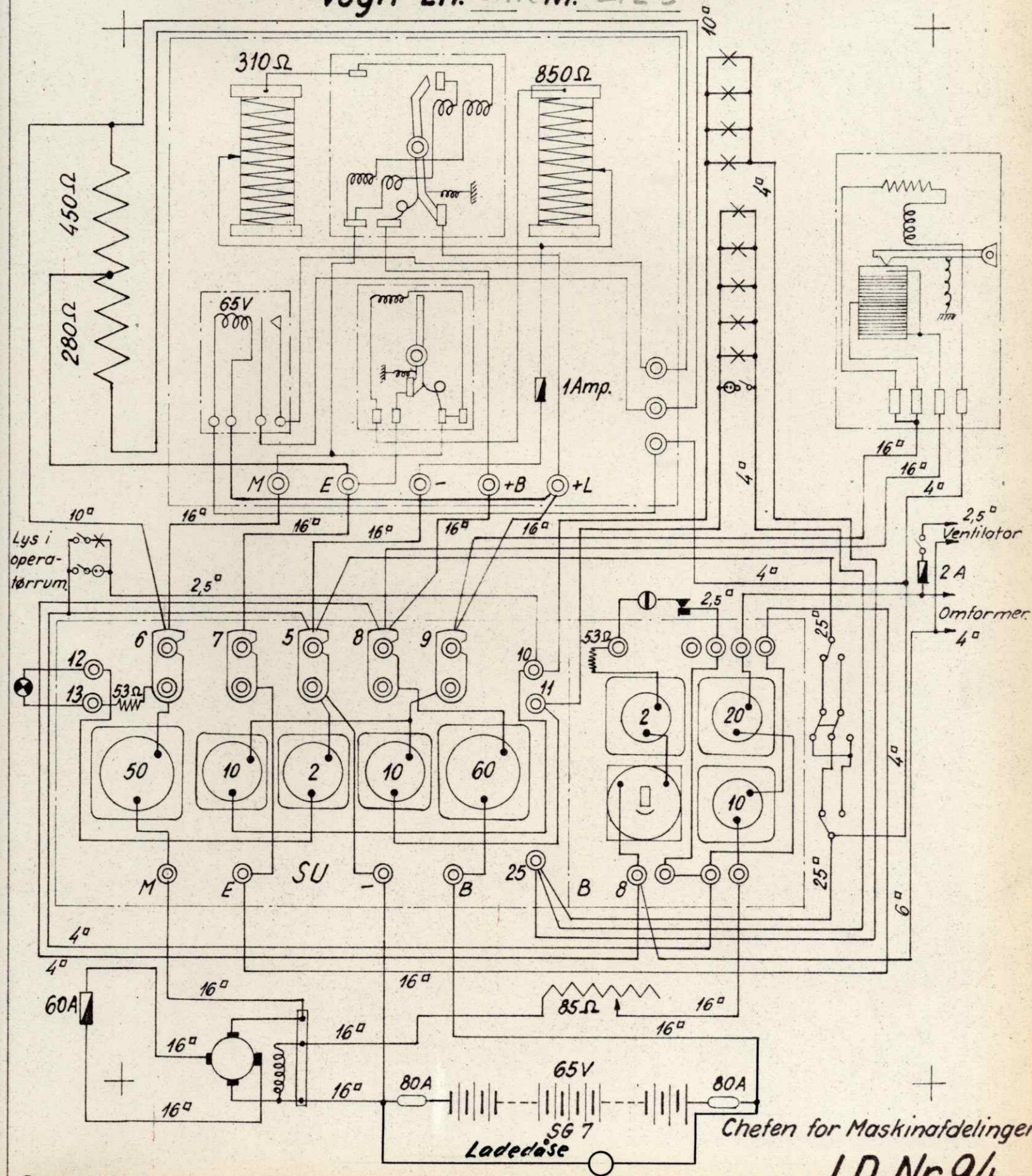

Chefen for Maskinafdelingen

LD. Nr. 94.

Rosenberg-Dynamoanlæg.

Vogn Ltr. Co Nr. 2505

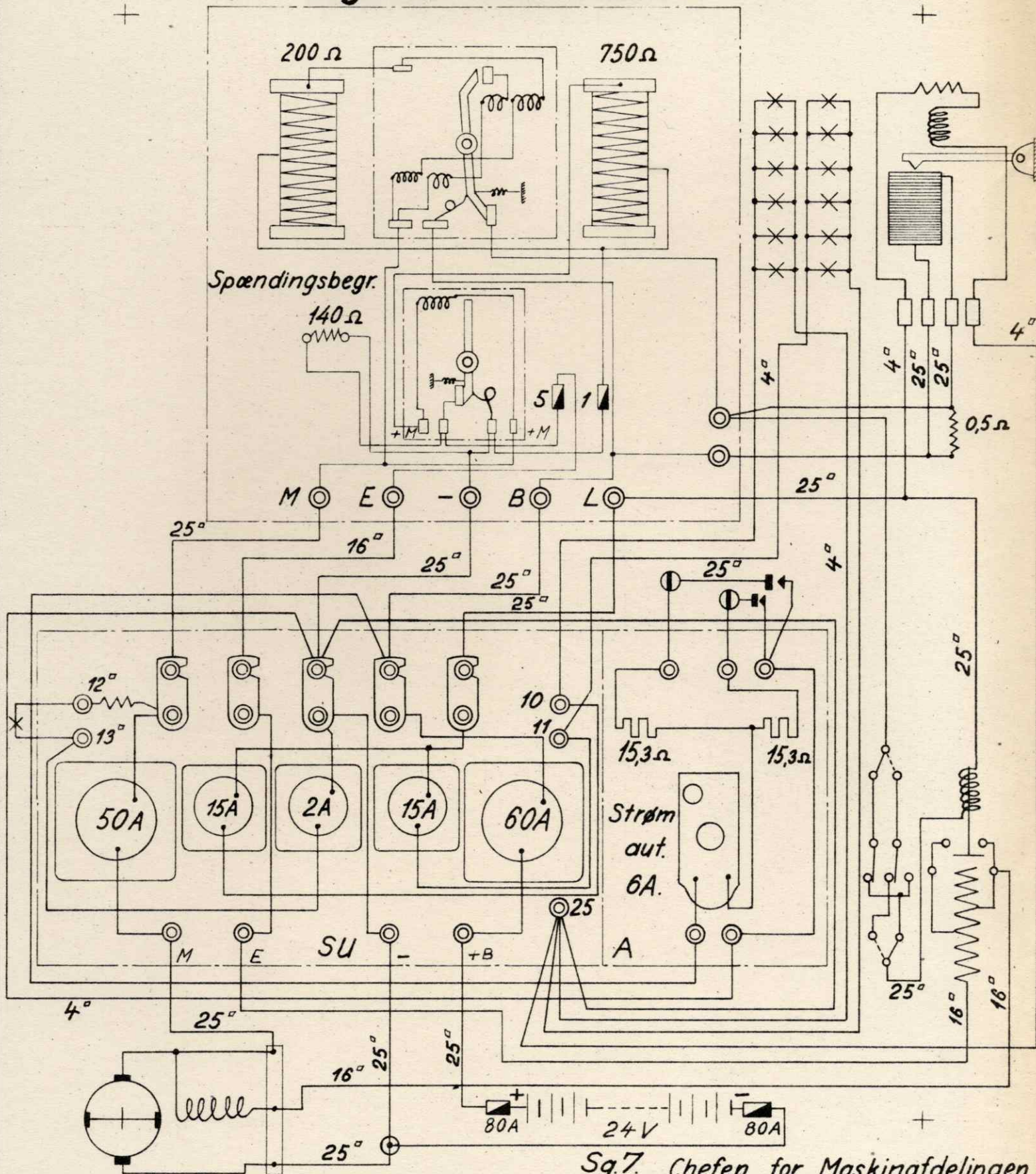

Sg.7. Chefen for Maskinafdelingen.

LD.Nr. 95

Rosenberg-Dynamoanlæg.

Vogn Ltr. _____ Nr. _____

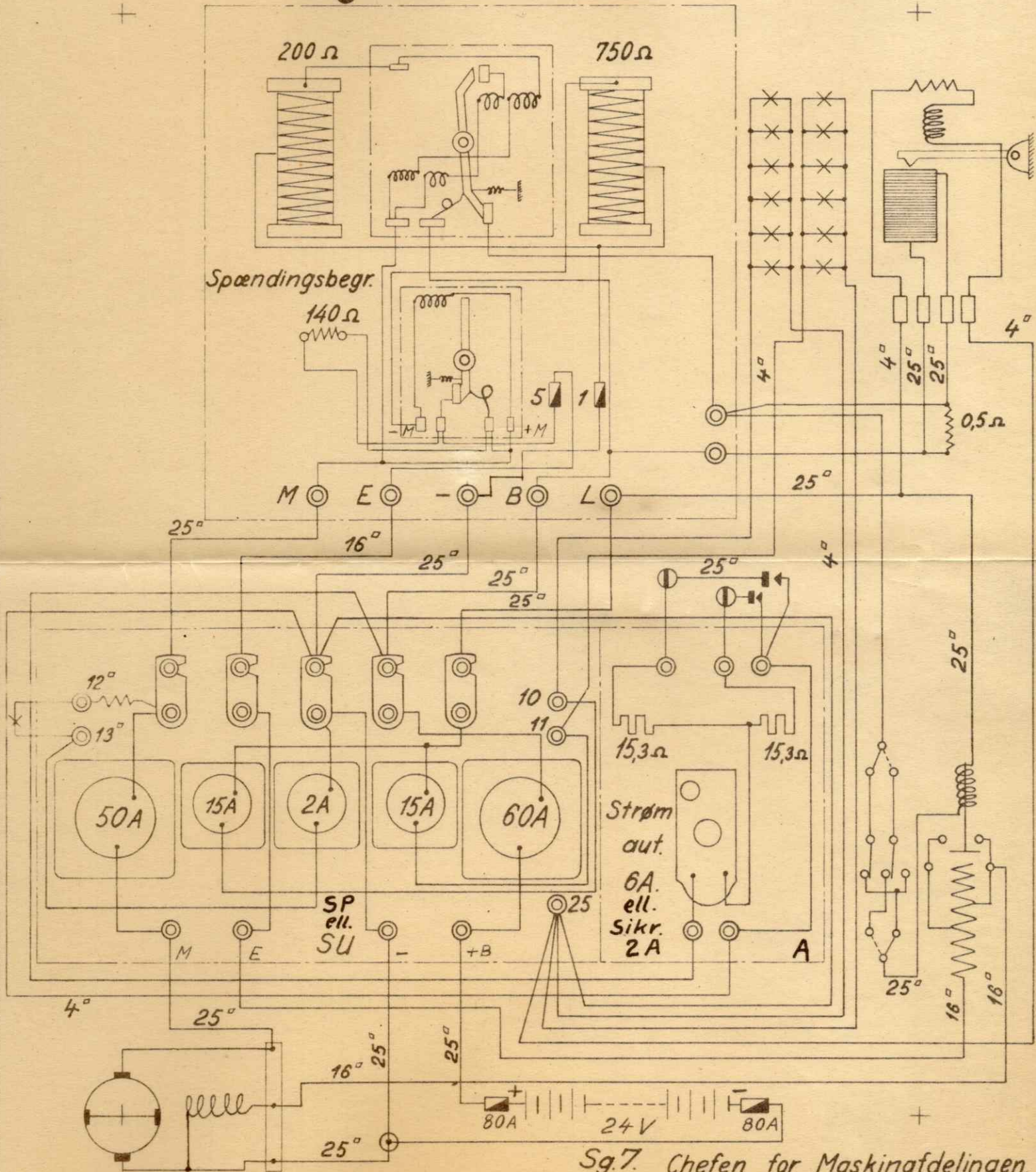

Sg.7. Chefen for Maskinafdelingen.

LD.Nr. 95

Rosenberg Dynamoanlæg.

Vogn ltr. CLE nr. 1684-99

QSL 203
D 30

Lysregulator

Siemens
NKR 24/III
35 Amp

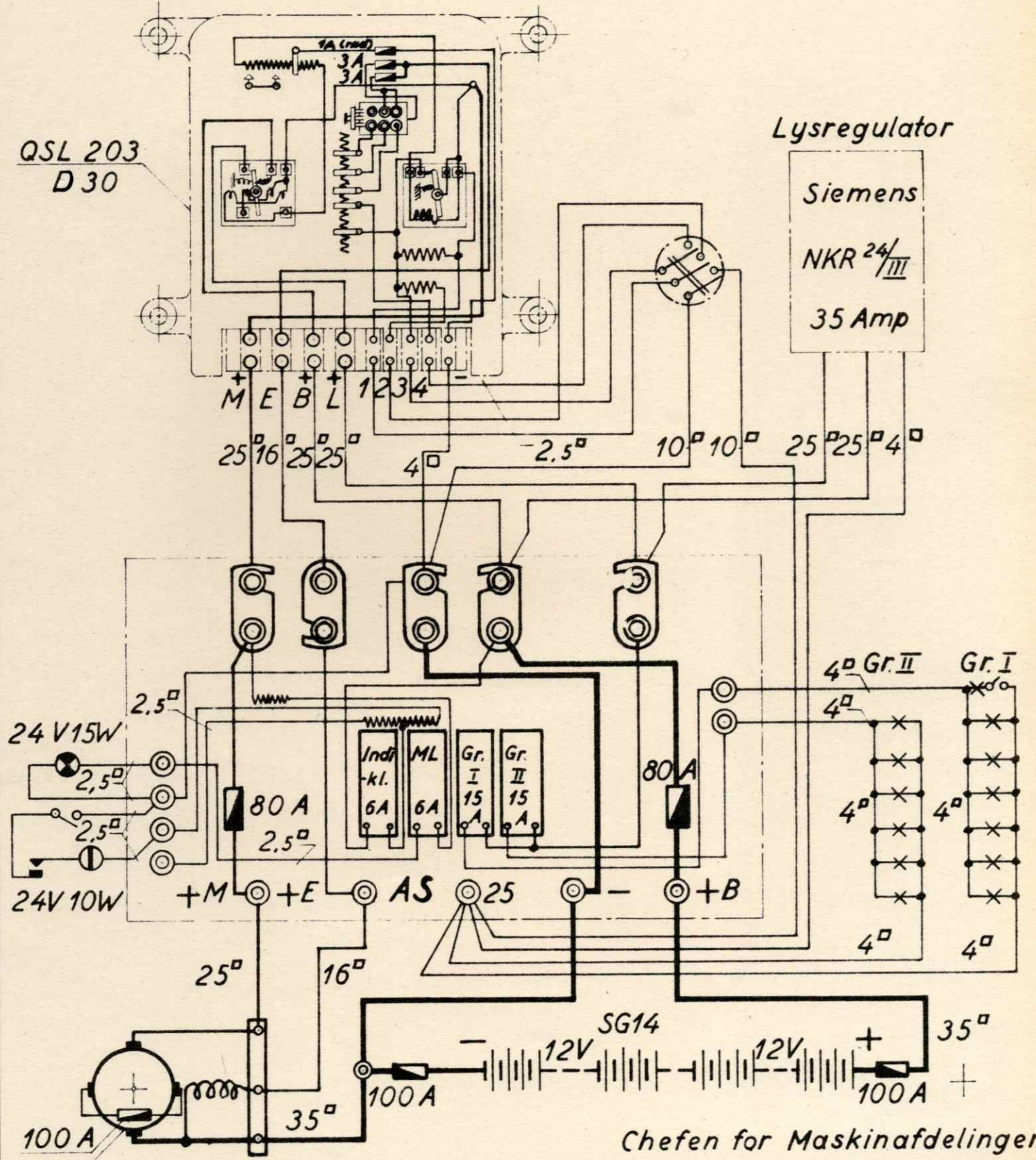

Chefen for Maskinafdelingen.

LD. nr. 97.

Rosenberg Dynamoanlæg.

Vogn ltr. CLE nr. 1684-99

QSL 203
D30

Overspændingsautomat

Lysregulator

Siemens
NKR 24/III
35 A

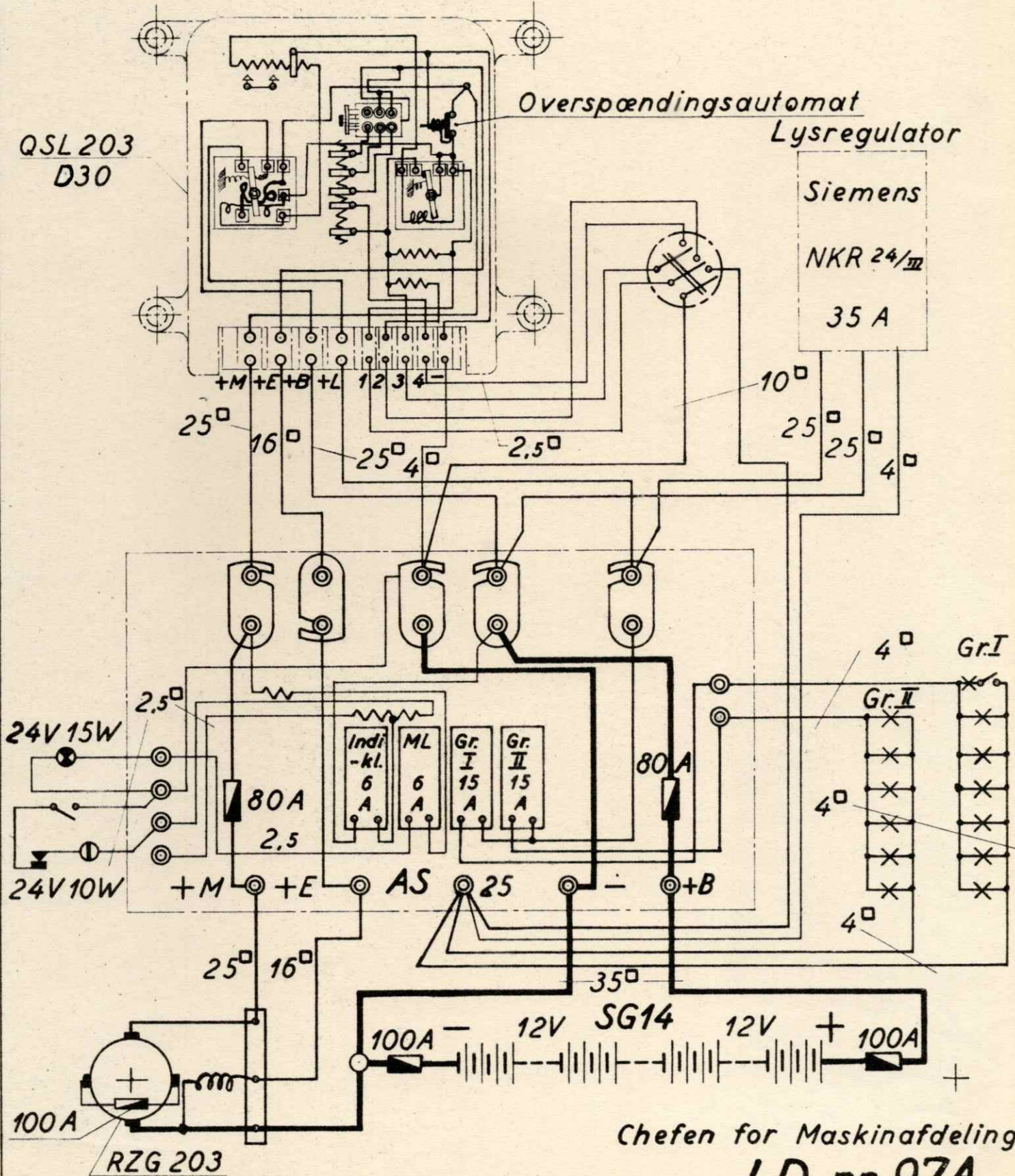

Chefen for Maskinafdelingen.

LD. nr. 97A.

Rosenberg Dynamoanlæg.

Vogn ltr. nr. _____

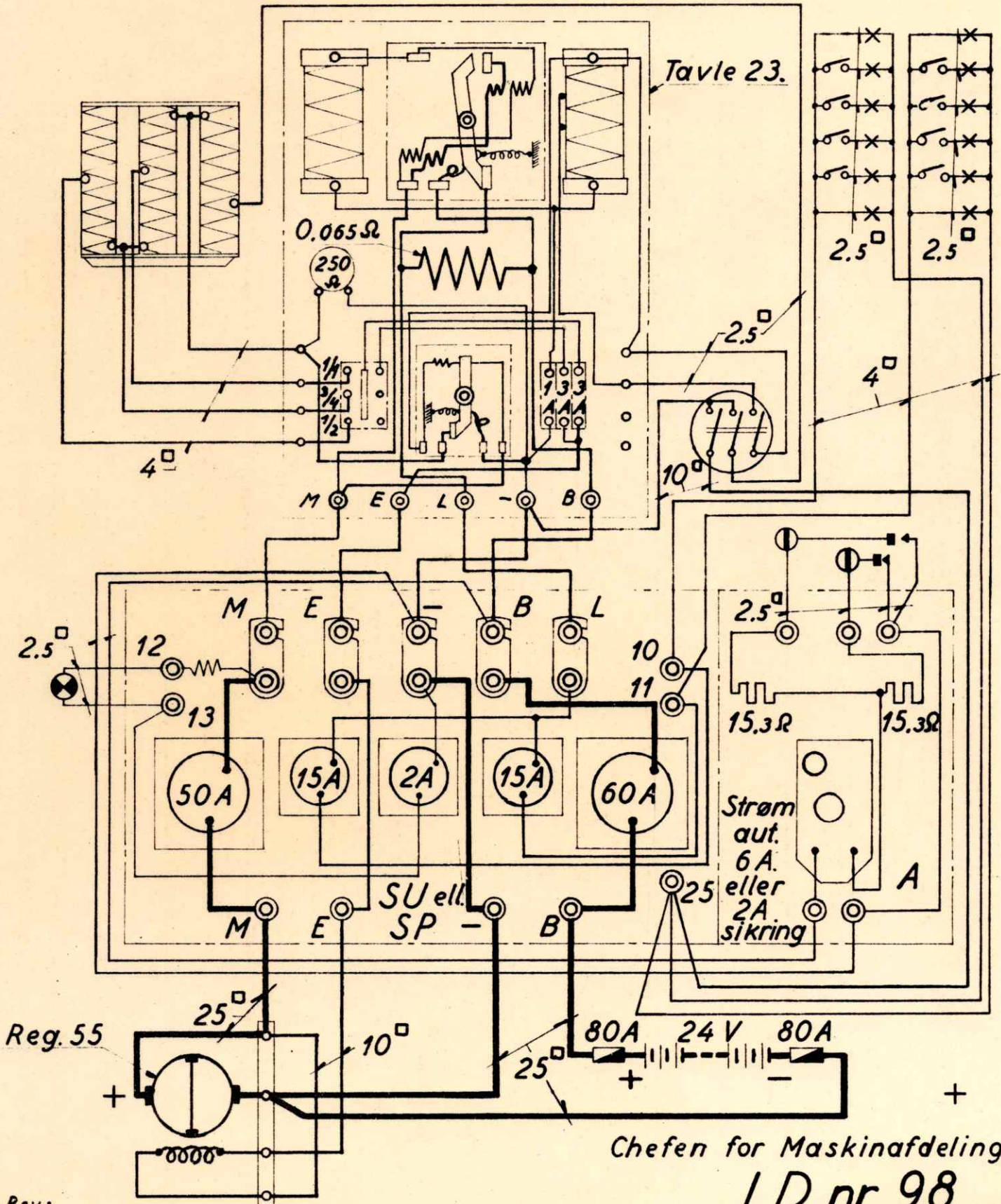

Rosenberg Dynamoanlæg

Vogn ltr. nr. _____

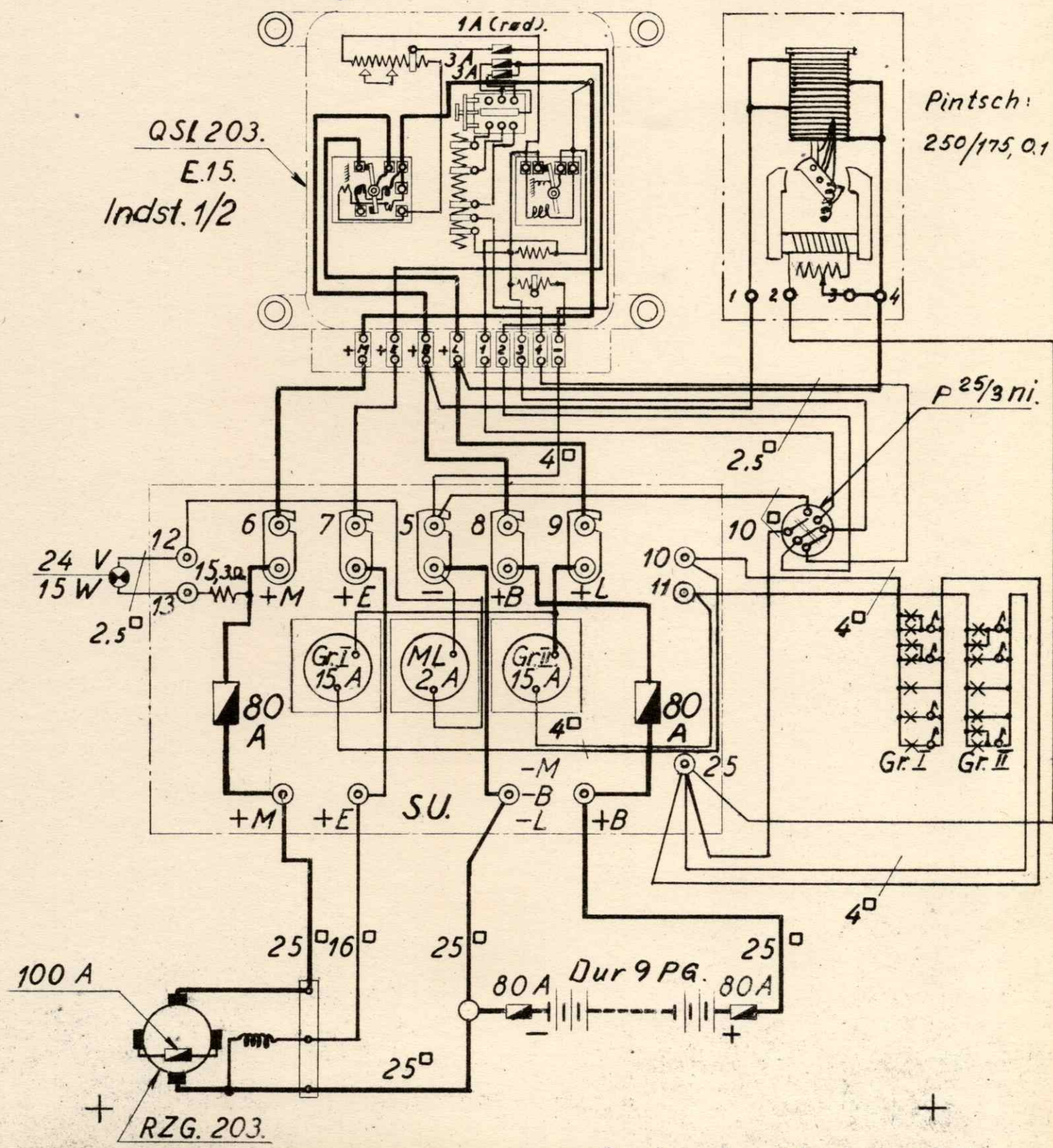

Chefen for Maskinafdelingen.
LD. nr. 99.

2DH.11200-1

Rev. 25/10-54.

Rosenberg Dynamoanlæg.

Vogn ltr. nr. _____

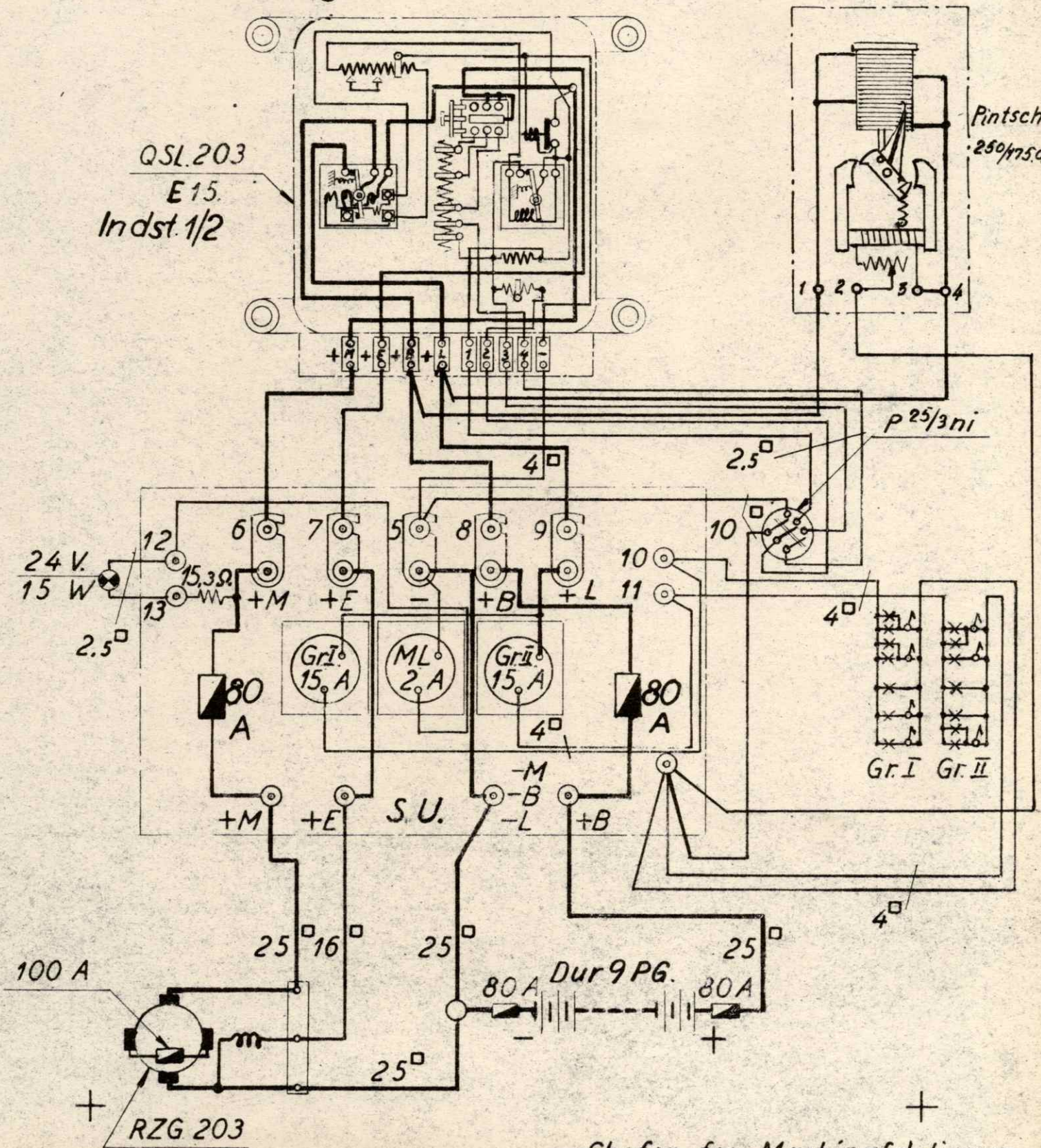

Chefen for Maskinafdelingen.

LD. nr. 99 A.

2. Dh. 11.200-1

Rosenberg Dynamoanlæg.

Vogn ltr. nr. _____

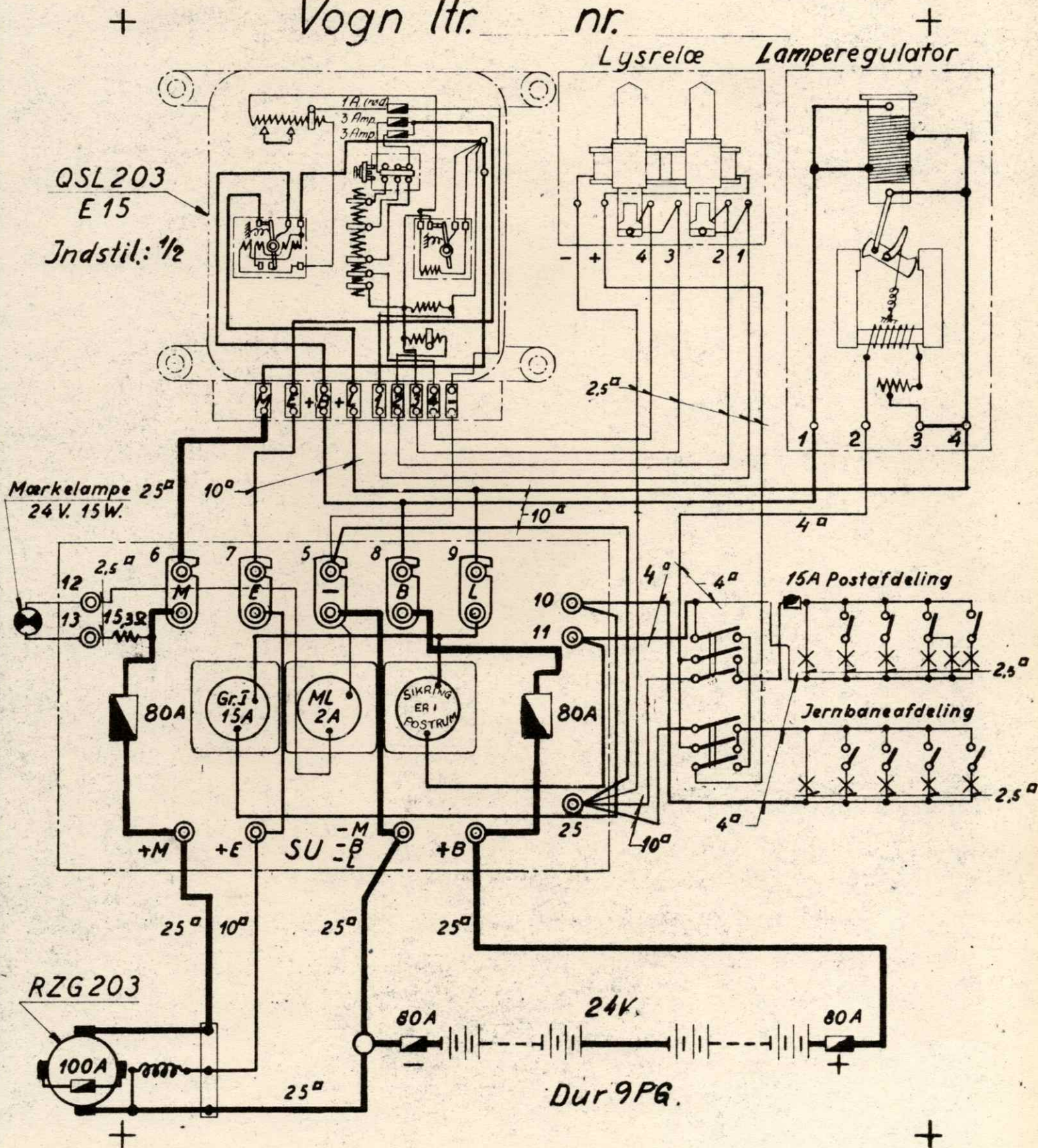

Chefen for Maskinafdelingen.

LD. nr. 101.

4DJ. 11.200.-1

Rosenberg Dynanoanlæg.

Vogn ltr. _____ nr. _____

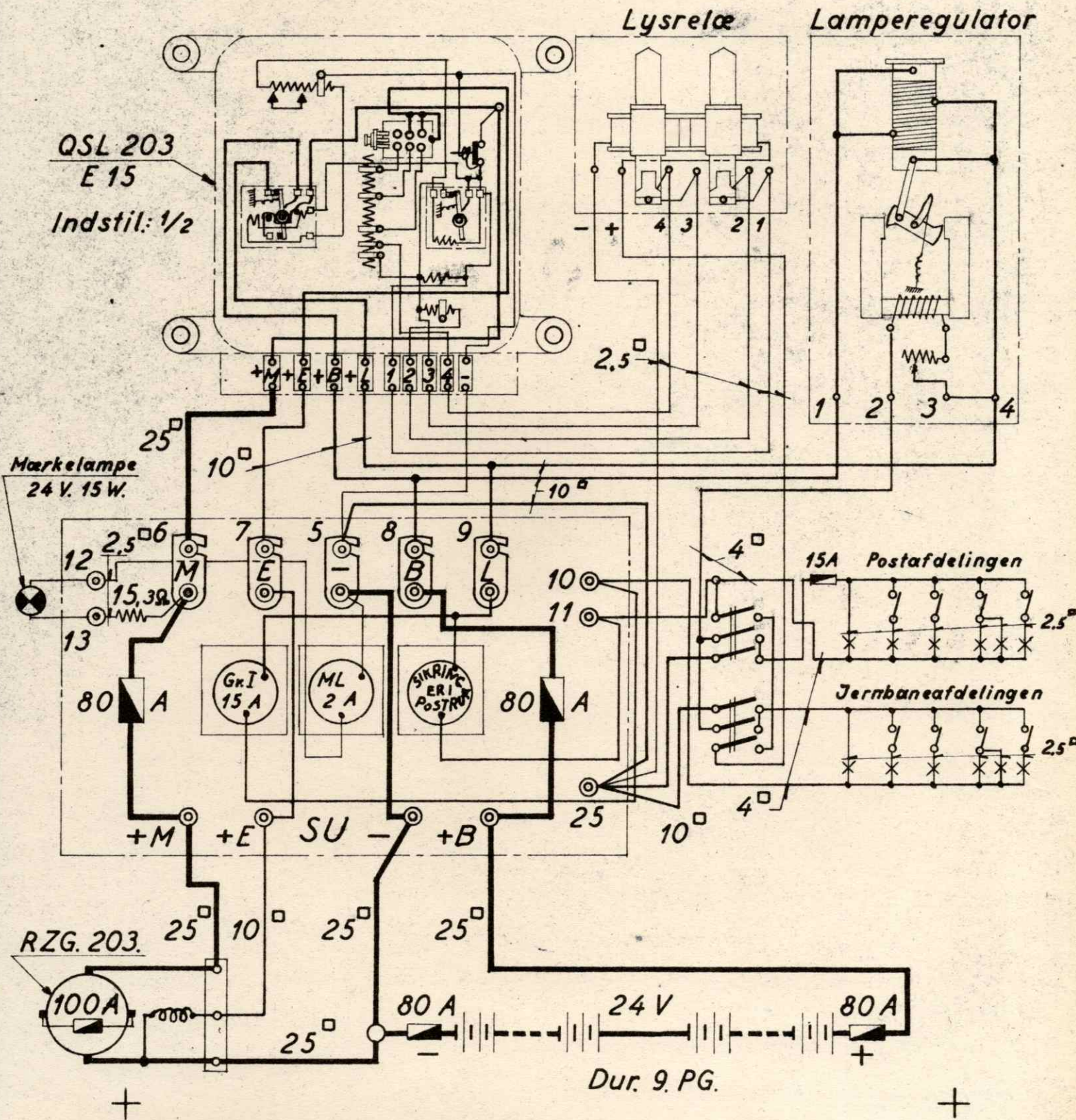

Chefen for Maskinafdelingen.

LD. nr. 101A.

Thrige - Dick - Dynamoanlæg.

Vogn. Ltr. Nr.

P:ntsch 54/13.08.

Dick Reg.
F S R - L.

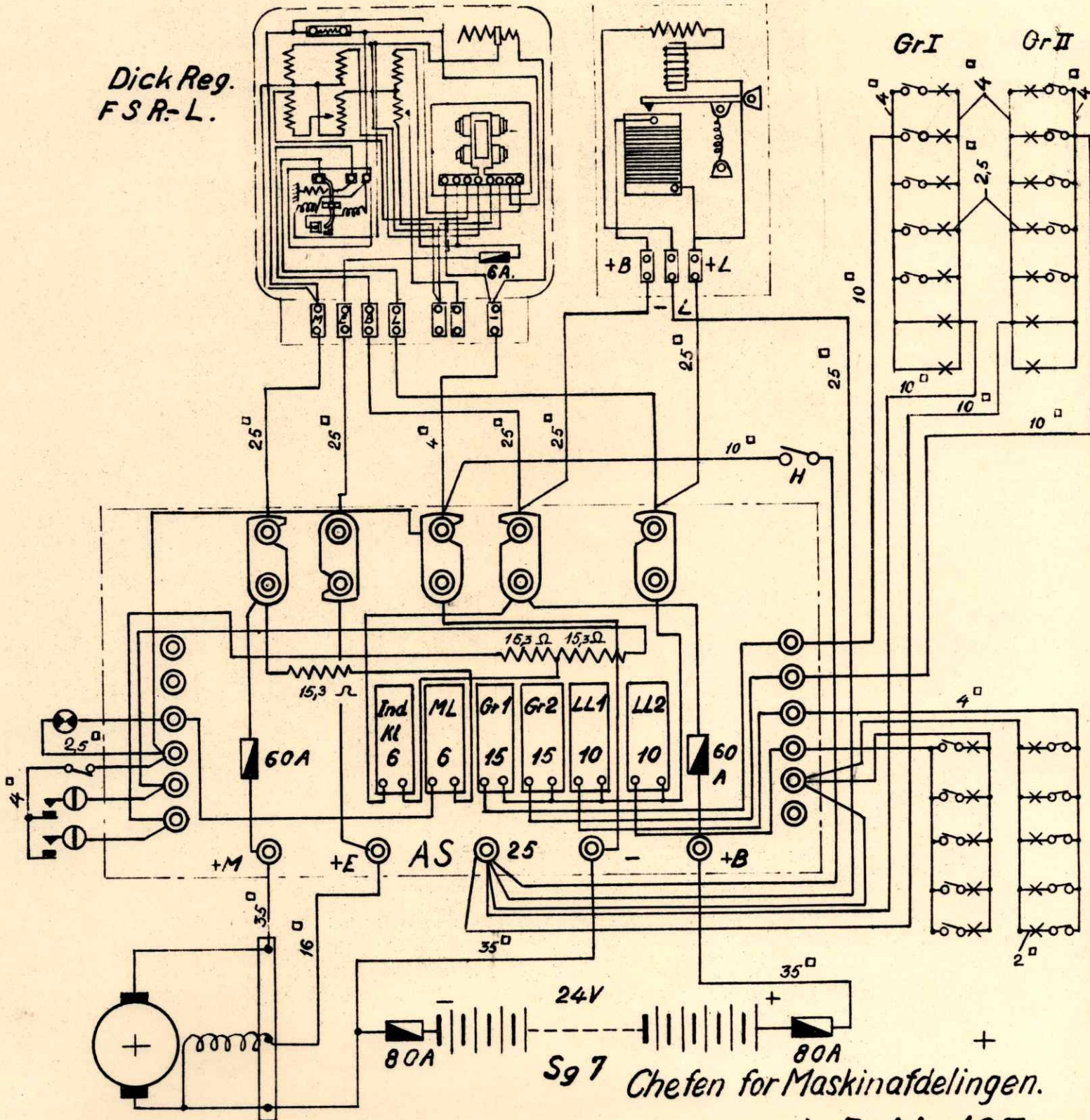

Sg 7 Chefen for Maskinafdelingen.

L D. Nr. 103.

Pintsch-Dynamo

Vogn. ltr. nr _____

54^I WK.

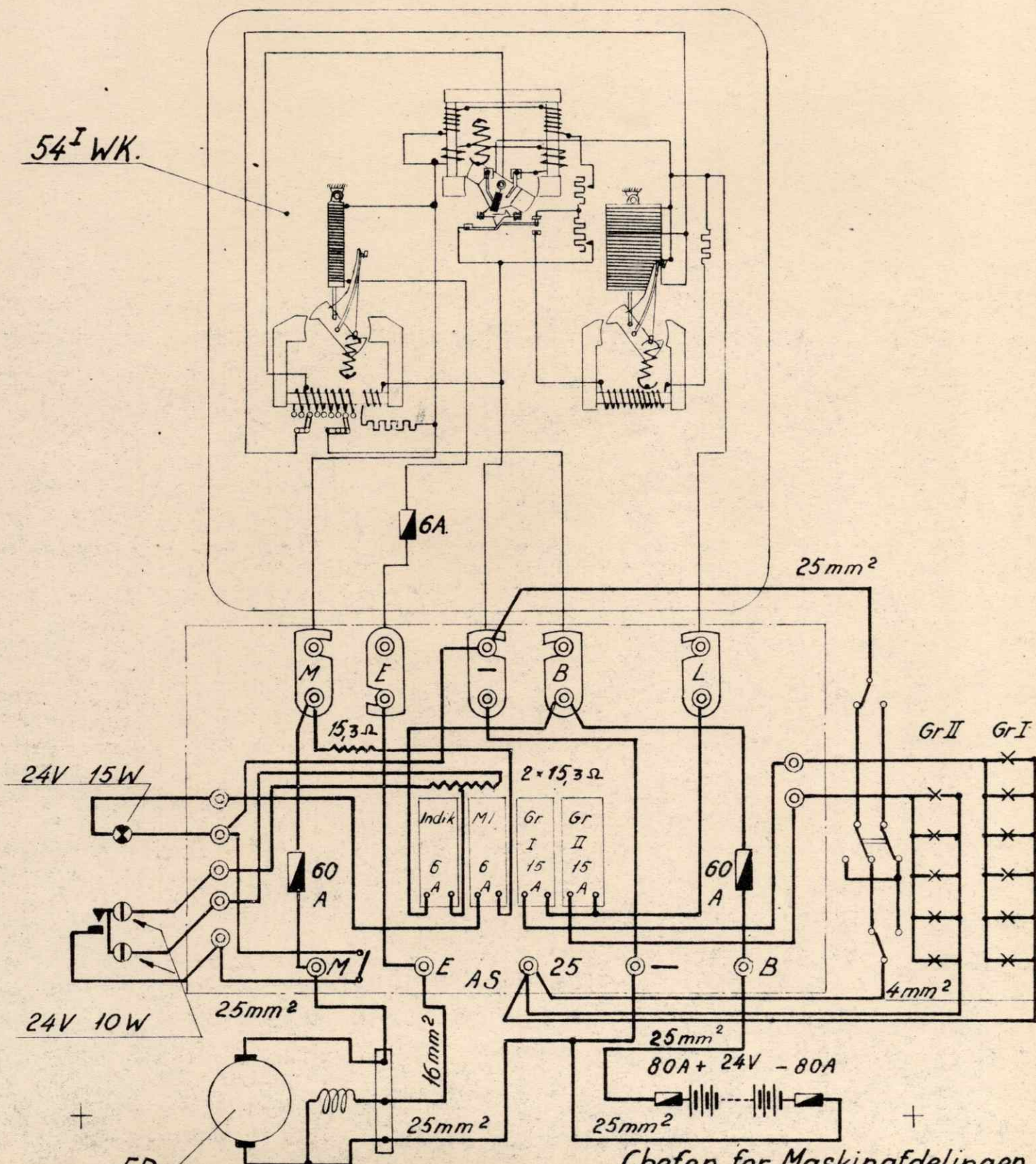

Chefen for Maskinafdelingen.

LD.Nr. 104.

Thrige.-Dick-Dynamoanlæg.

Vogn.Ltr. Nr.

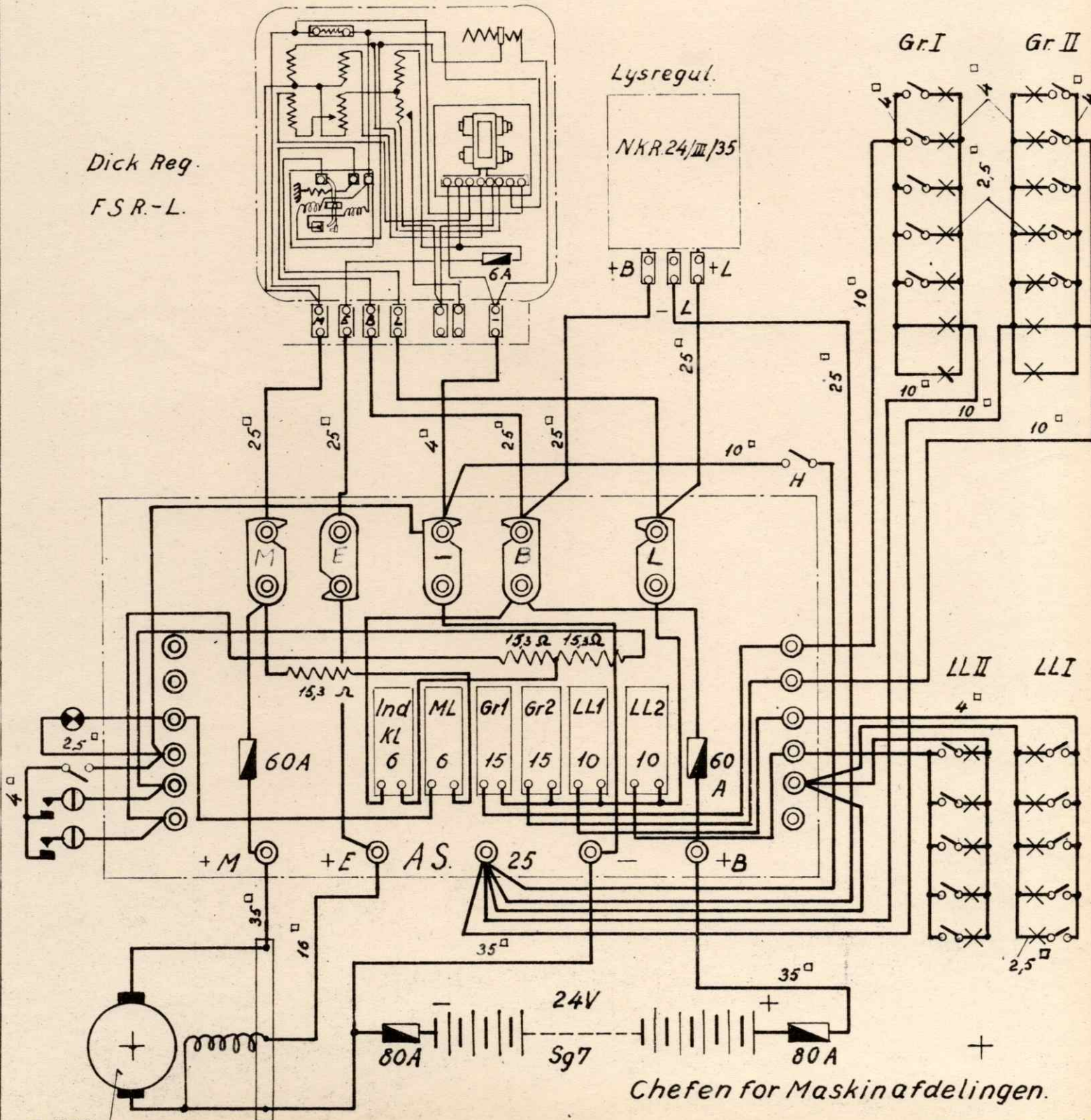

CF.12

Chefen for Maskinafdelingen.

L.D.nr.107.

G. E. Z. Dynamo.

Vogn ltr. nr. _____

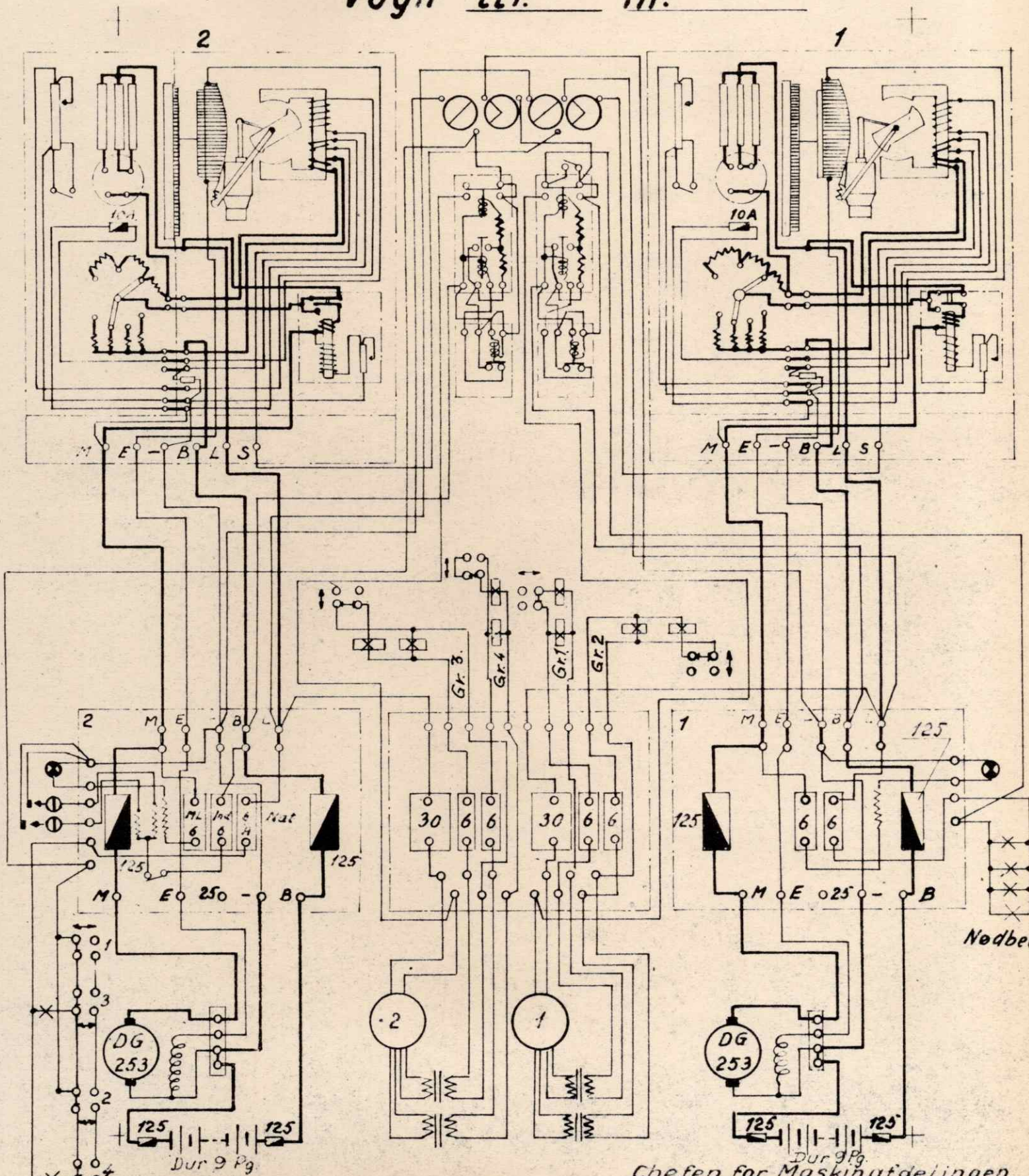

CCIII. 11.200.

Natbel.

Chefen for Maskinafdelingen.

LD. nr. 108.

G. E. Z. Dynamo.

Vogn ltr. nr. _____

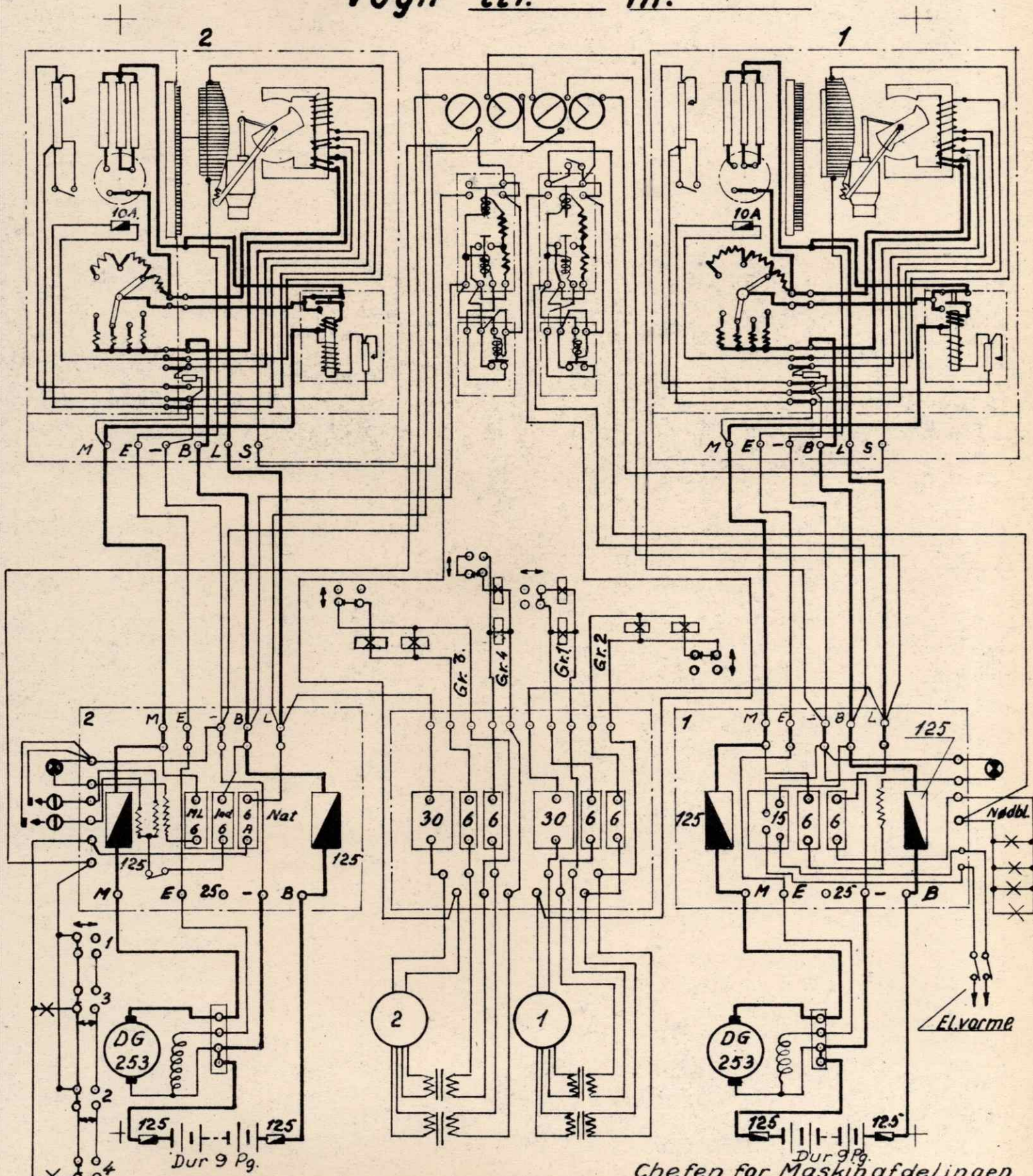

CCIV. 11.200.

Chefen for Maskinafdelingen.

LD. nr. 109.

Pintsch Dynamoanlæg.

Vogn ltr. nr. _____

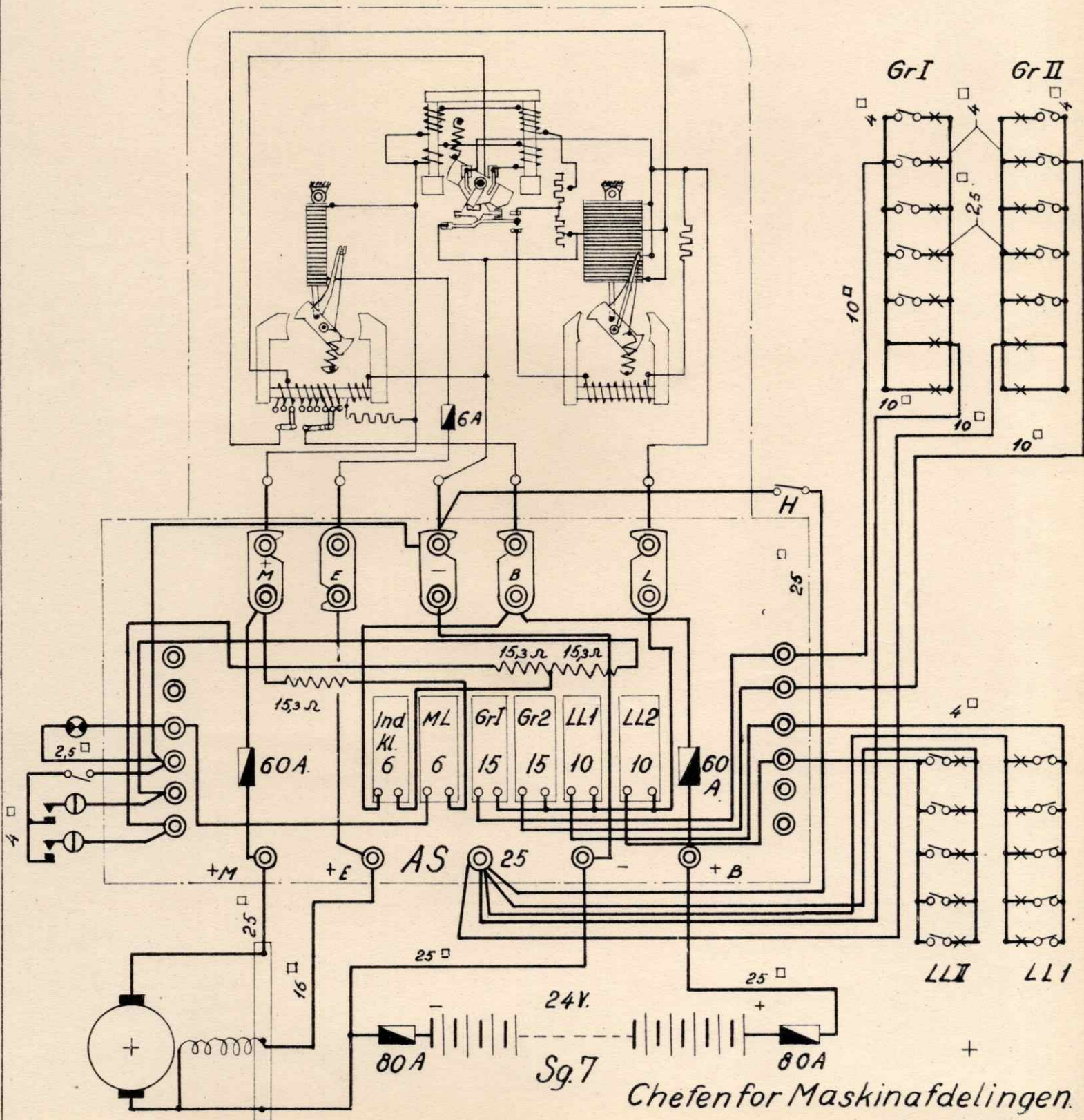

Chefen for Maskinafdelingen.

L D. Nr. 110

Rosenberg Dynamoanlæg.

Vogn Itr. CRS. nr.

Tavle nr.34

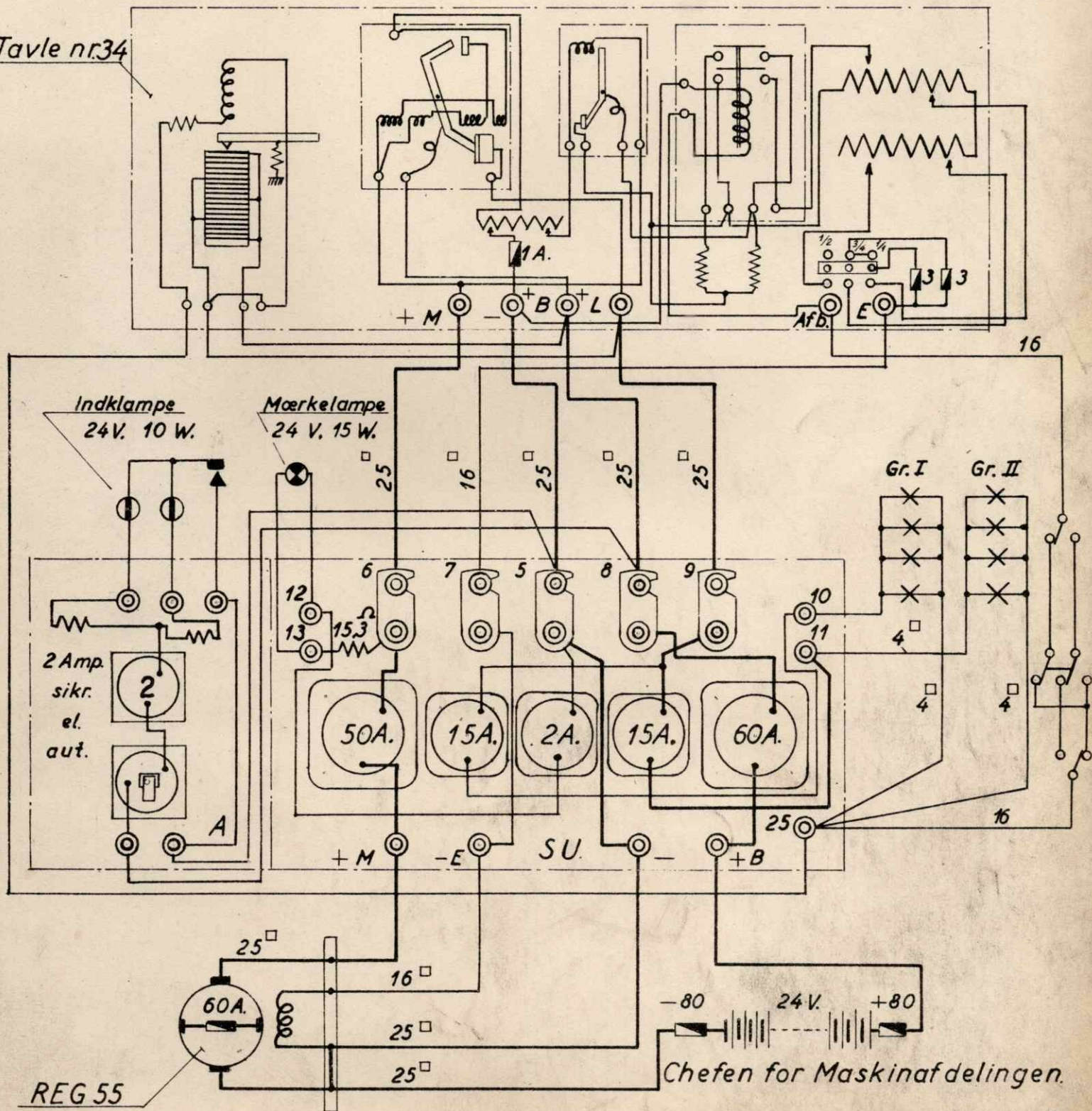

LD.113

Pintsch dynamo.

Vogn ltr. nr. _____

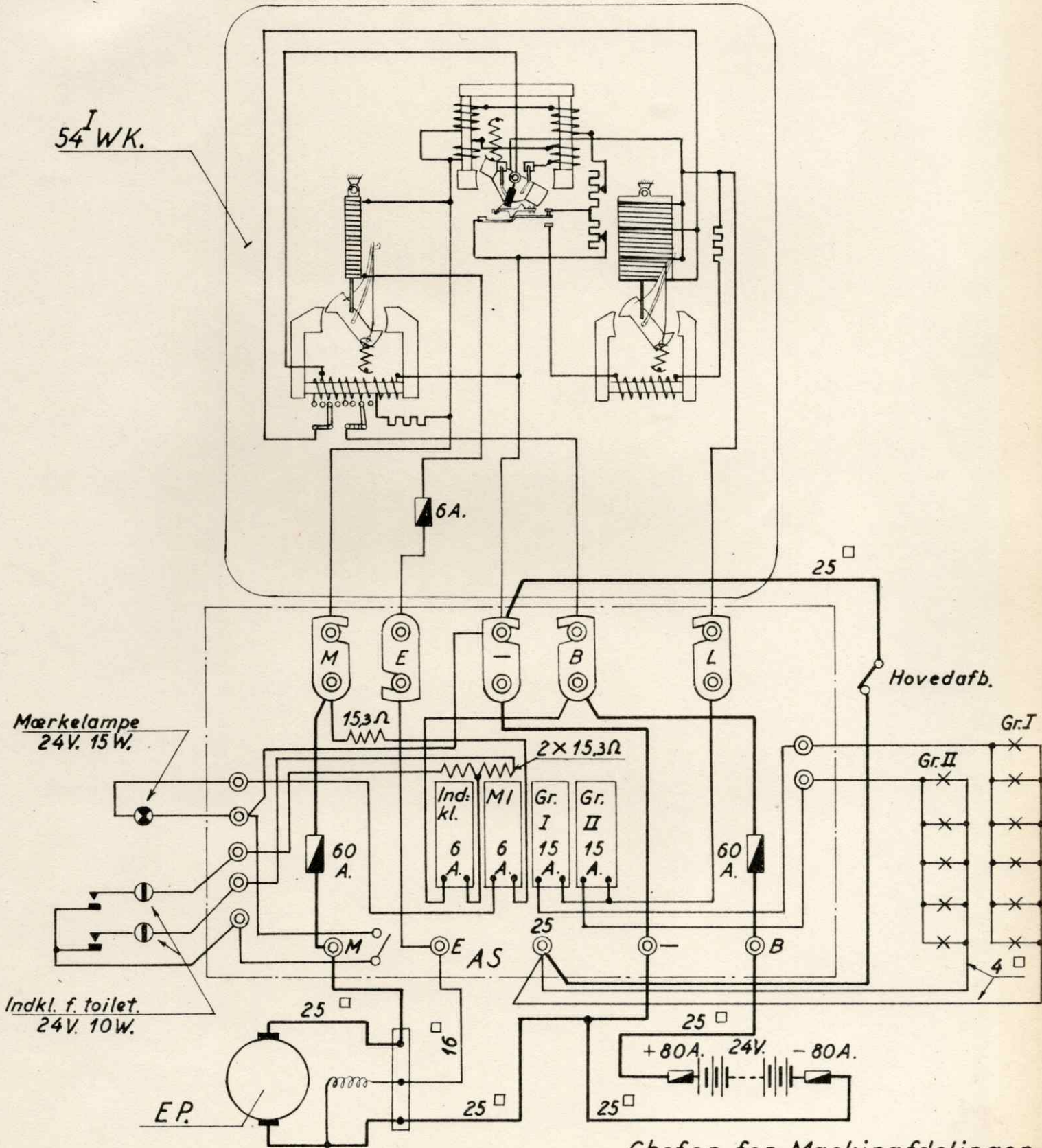

Chefen for Maskinafdelingen.

LD. nr. 114.

2.BP. 11.200-1.

Rev.

Thrige-Dick Dynamoanl eg

Vogn ltr. nr. _____

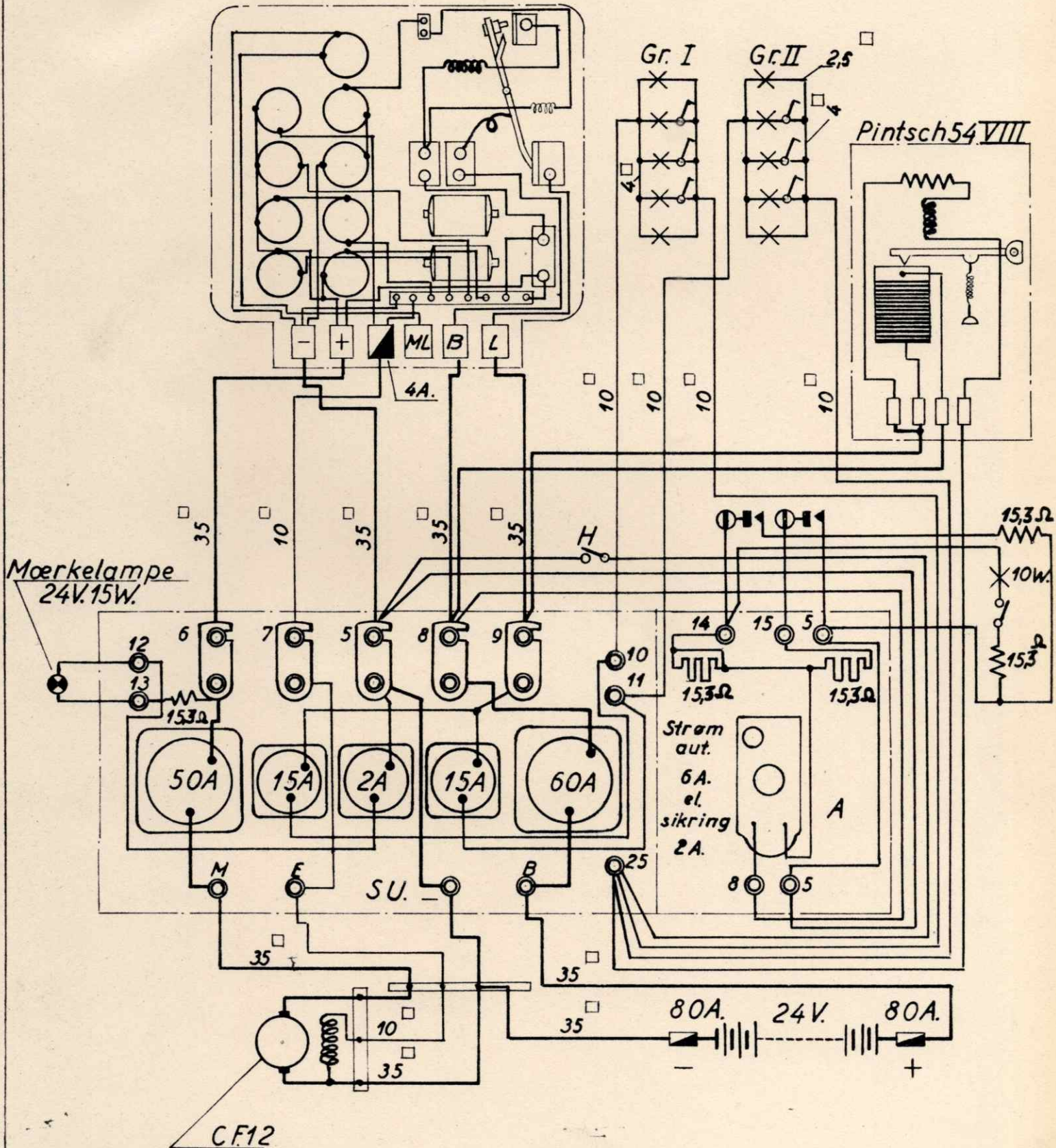

CAE. 11.200

Rev.

Chefen for Maskinafdelingen.

LD. nr.115

Pintsch-dynamo.

Vogn ltr. _____ nr. _____

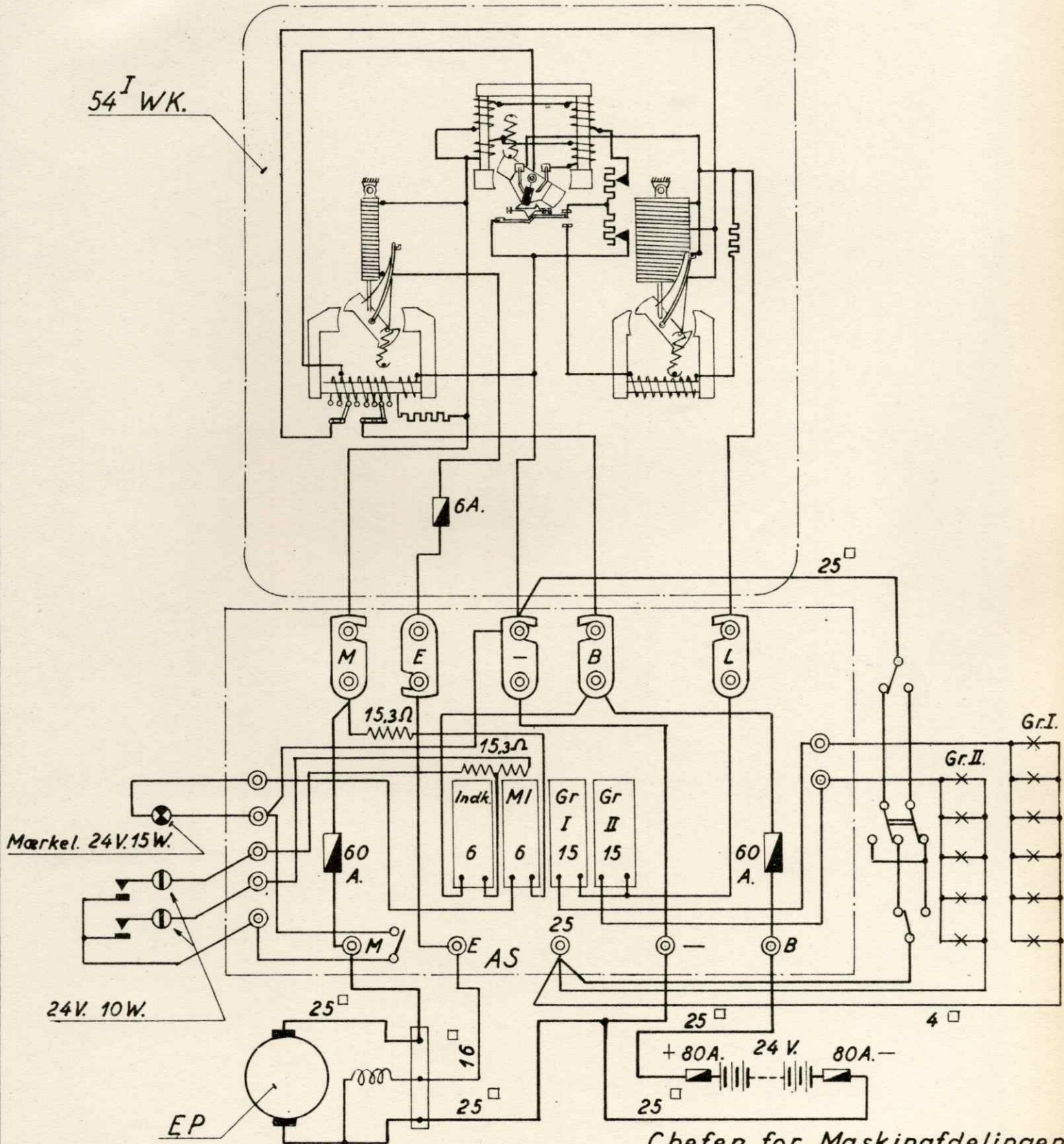

Chefen for Maskinafdelingen.

L.D. nr. 117.

4.Co.11.200-1.

Rev.

Rosenberg Dynamoanlæg.

Vogn ltr. _____ nr. _____

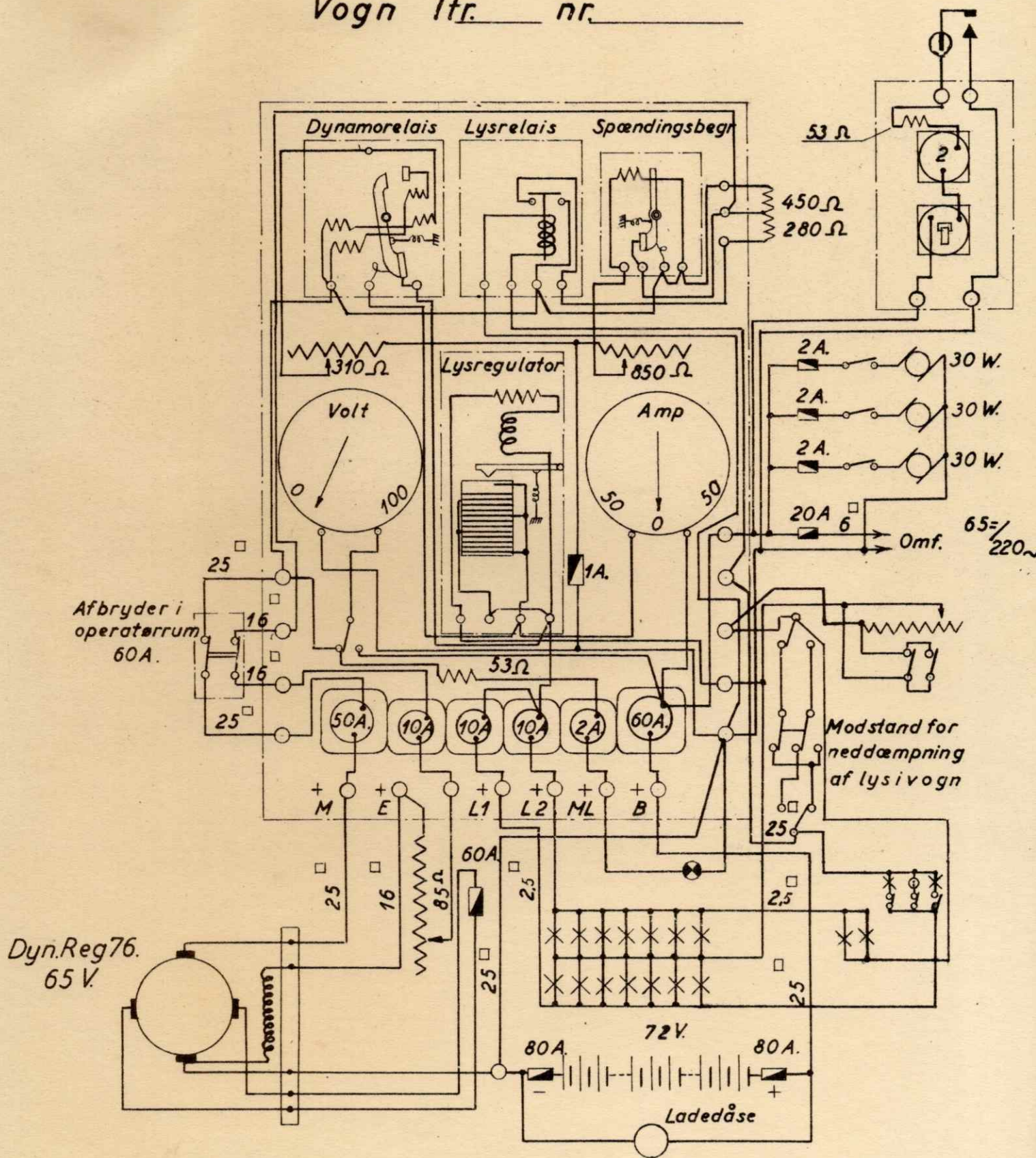

Chefen for Maskinafdelingen.

1.C.L.11.200-1

Rev.

L.D. 118.

Rosenberg-Dynamoanlæg.

Vogn Ltr. Nr.

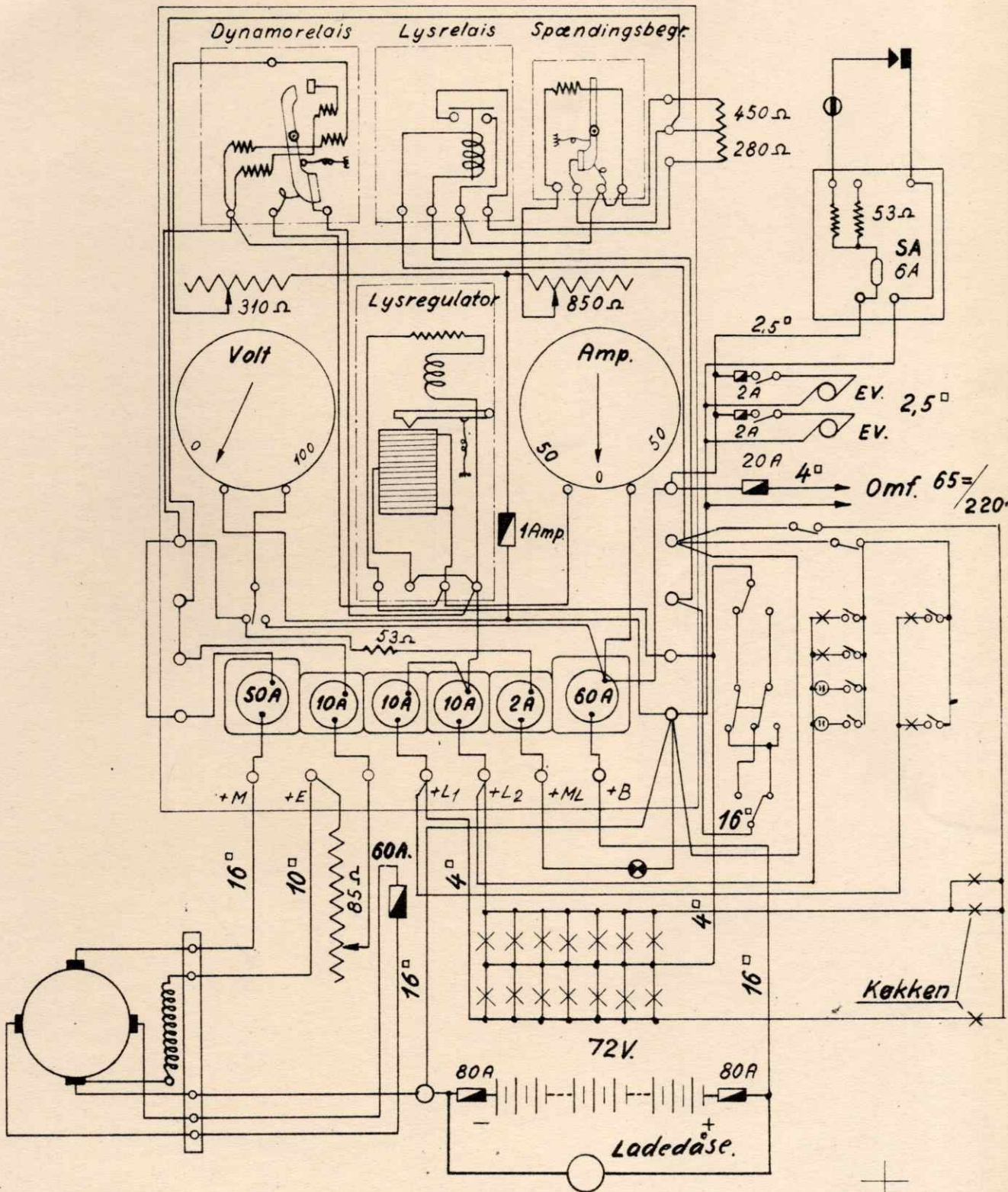

Dyn. Reg 76.
65 Volt.

Chefen for Maskinafdelingen.

LD. Nr. 119.

Max. Belastning: 23 Amp.

2. G.M.R. 11.200.

Rev

Li: 2 (A, E, F).

LA: 2 (C, D).

Pintsch dynamo

Vogn ltr. Av nr.

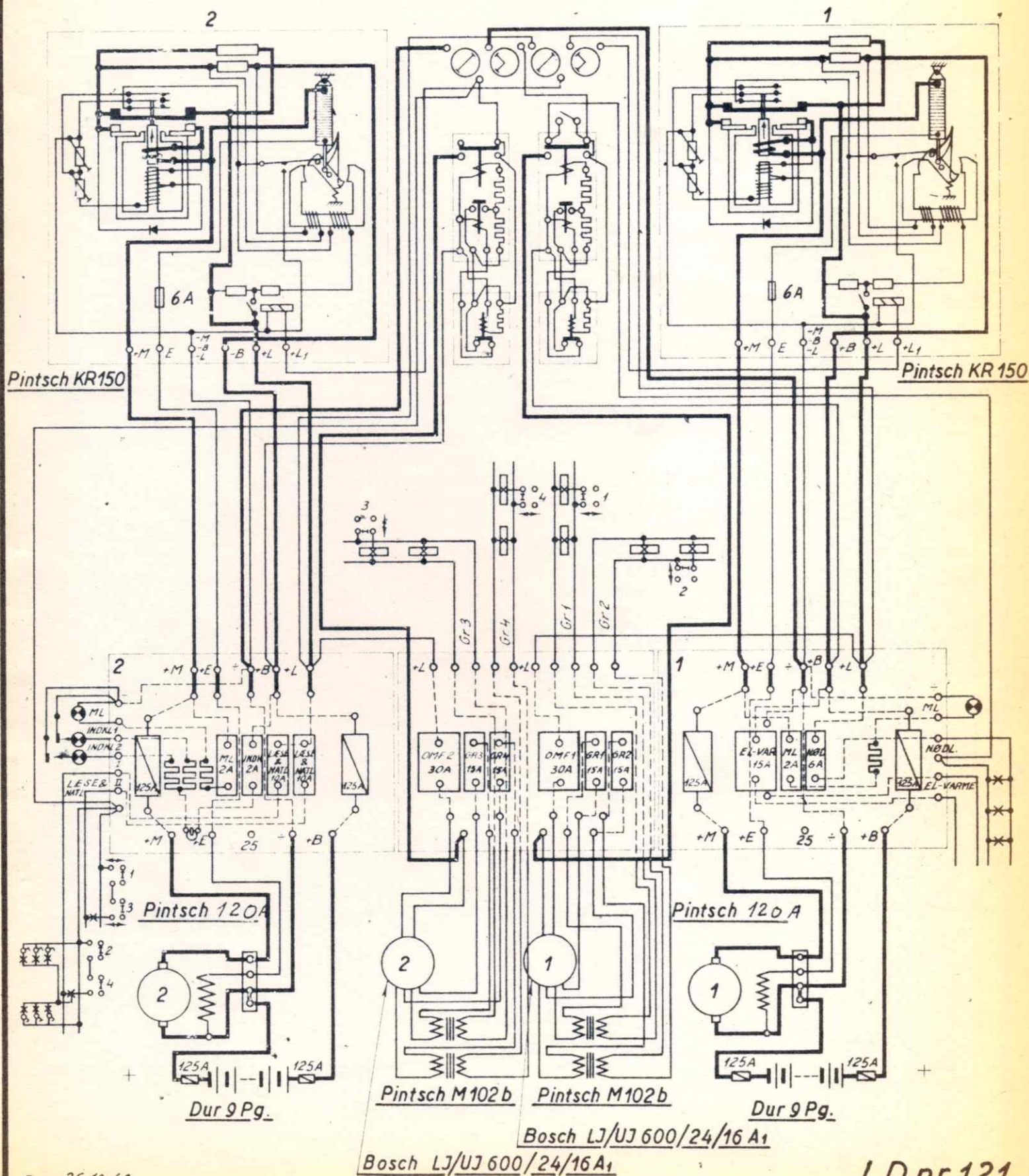

Pintsch KR150

Pintsch KR150

Pintsch 120A

Pintsch 120A

Dur 9 Pg.

Dur 9 Pg.

Pintsch M102b

Pintsch M102b

Bosch LJ/UJ 600/24/16 A1

Bosch LJ/UJ 600/24/16 A1

Rosenberg dynamoanlæg.

Vogn ltr. nr. _____

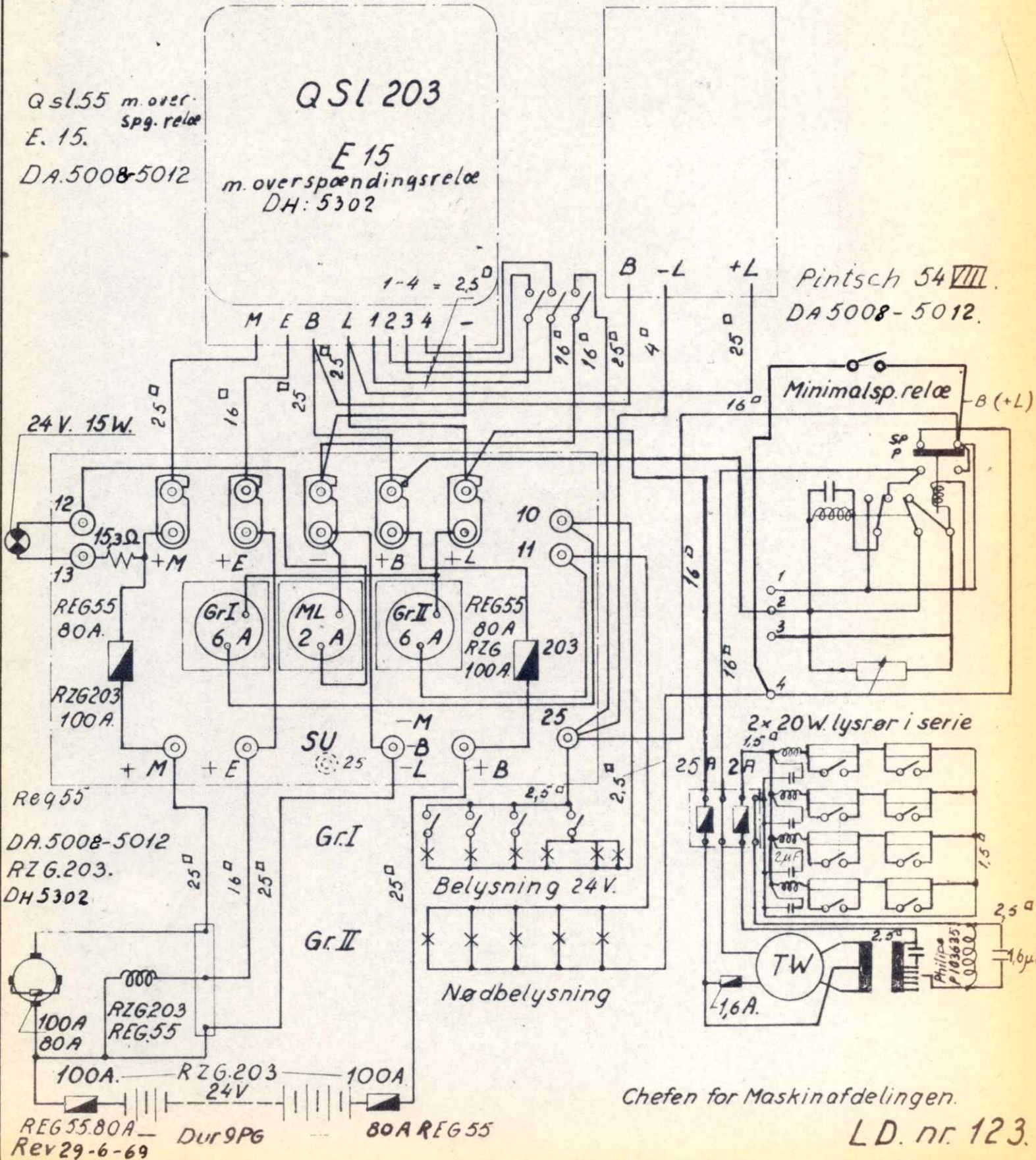

Li: 2 (A, E, F).

La: 1, 2 (A, D)

Pintsch dynamo

Vogn ltr. AL. nr.

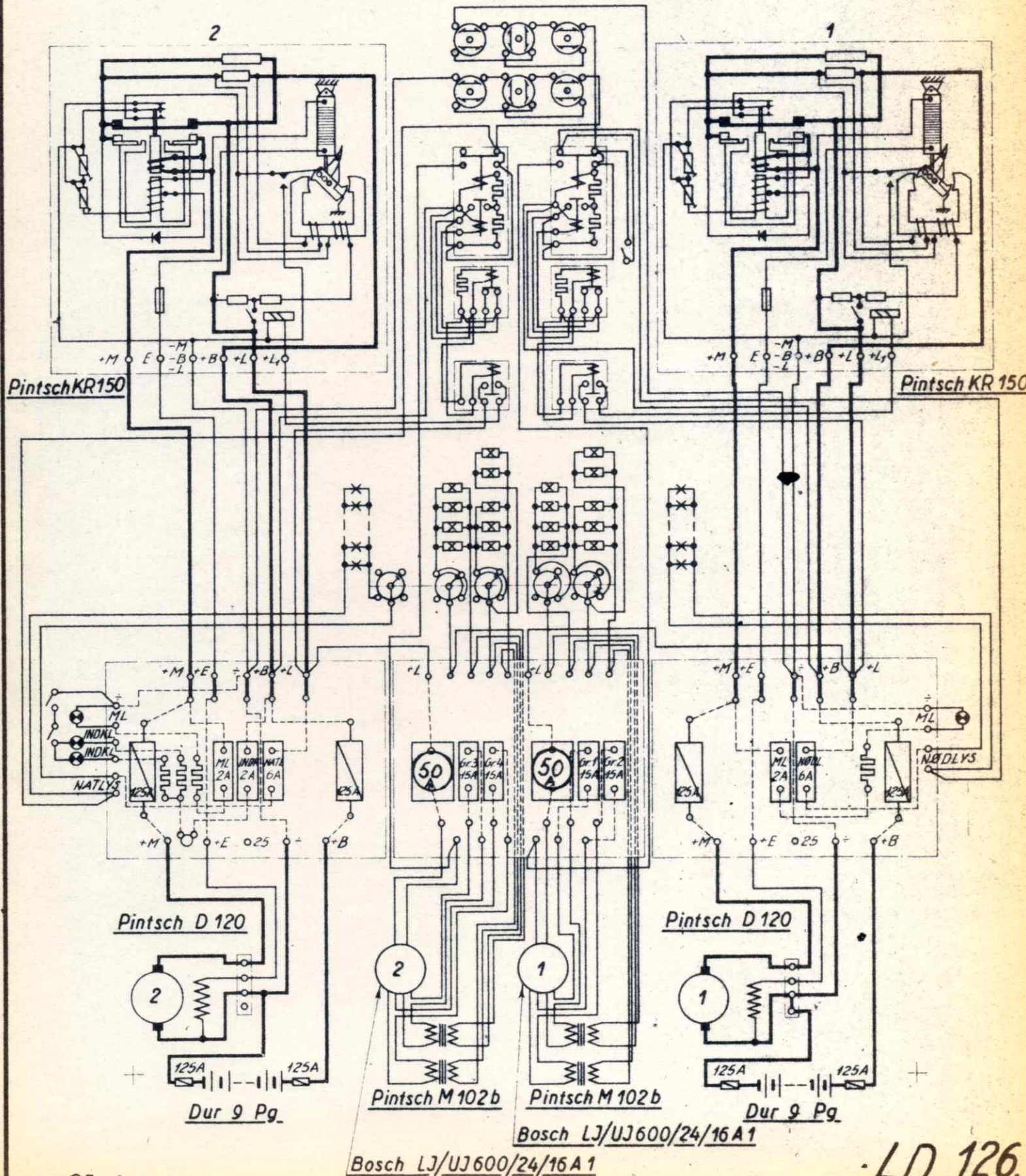

Pintsch Dynamoanlæg

Vogn Ltr. _____ nr. _____

ZR 50s.

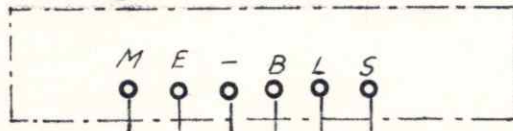

KR 150

Indstilling
(Grøn skole)

Li: 2,5 (A, D, F).

LA: 2,8 (B, D).

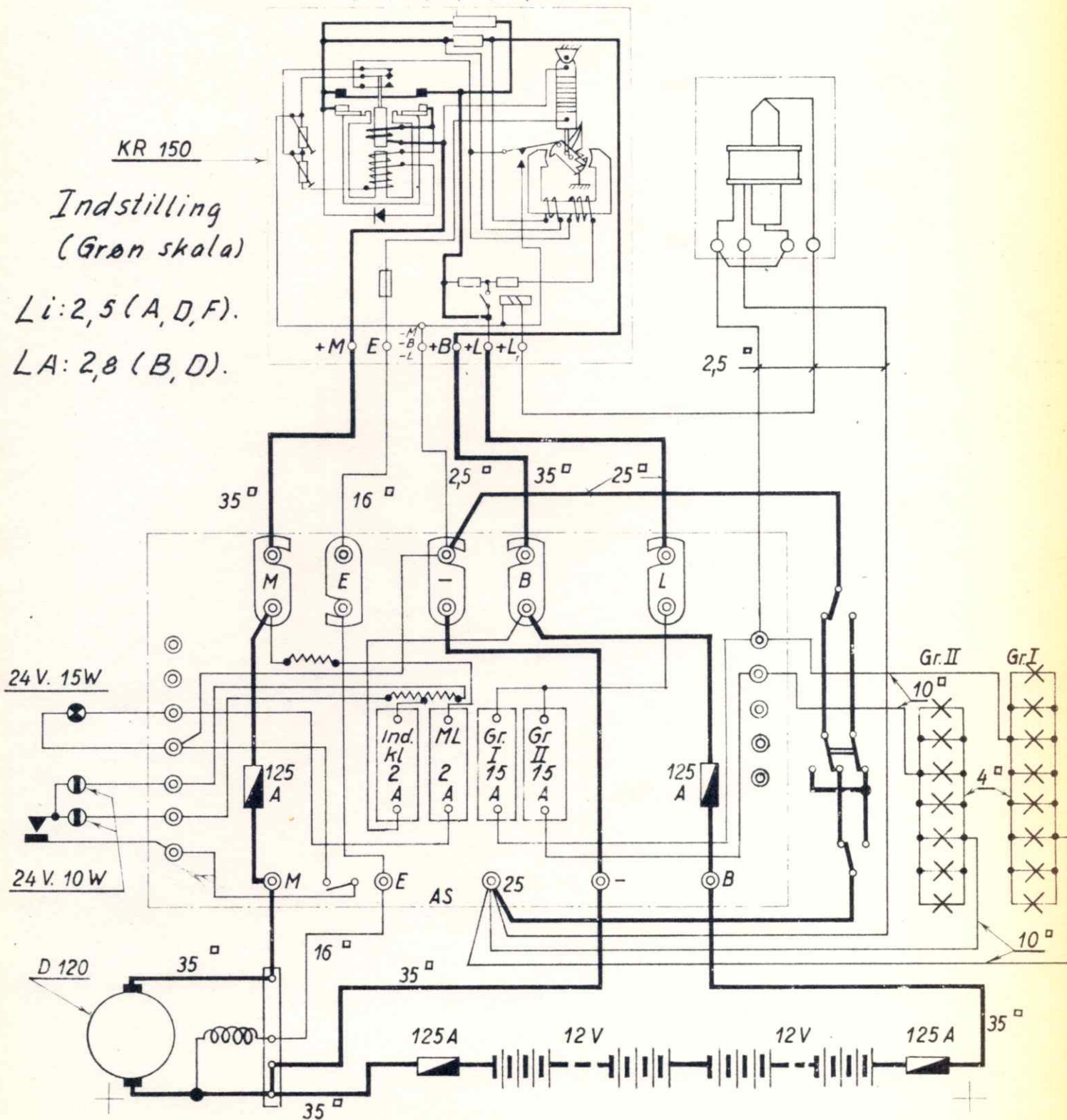

Chefen for Maskinafdelingen

LD. nr. 128.

Pintsch Dynamoanlæg

Vogn ltr. _____ nr. _____

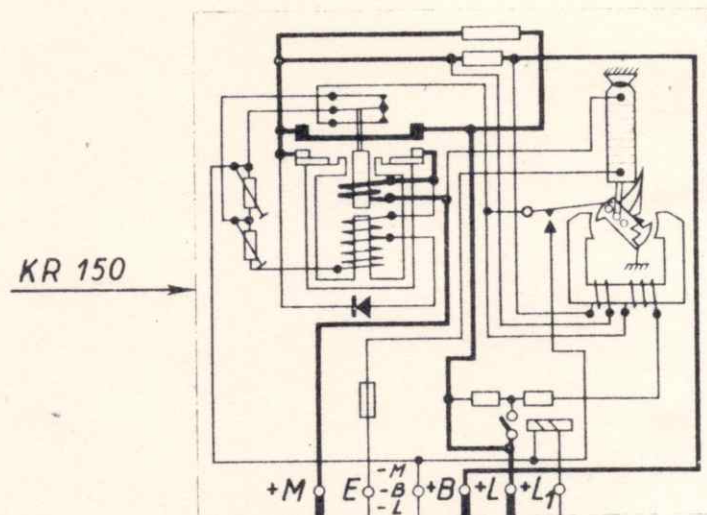

Indstilling (grøn skala),

LI: 2,5

LA: 2,8

Ved regul. skab GEZ: ZR 50 S
forbindes ledning L1 til klemme S.

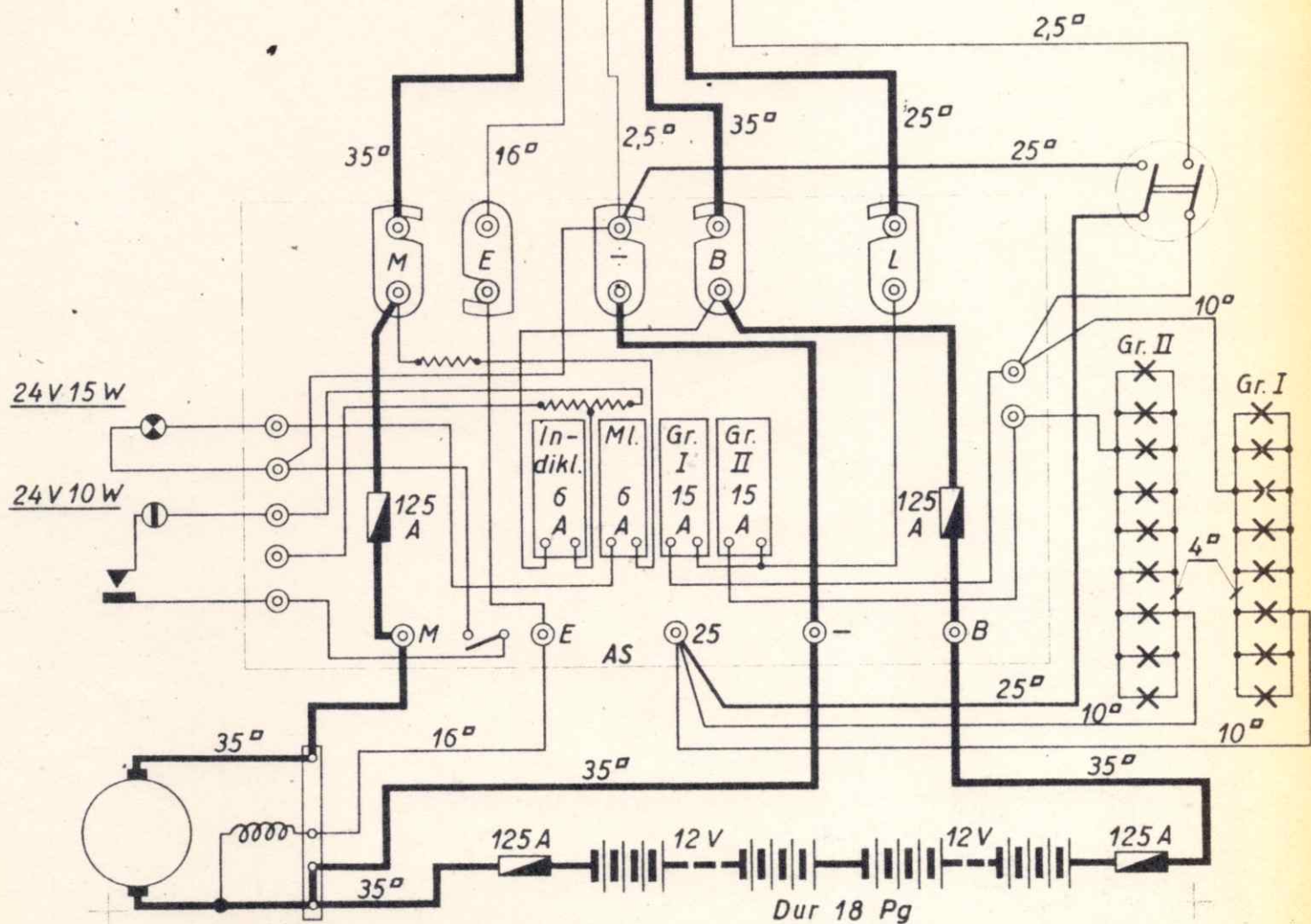

Chefen for maskinafdelingen

LD. nr. 129.

GEZ dynamo
Vogn ltr. Cc. nr.

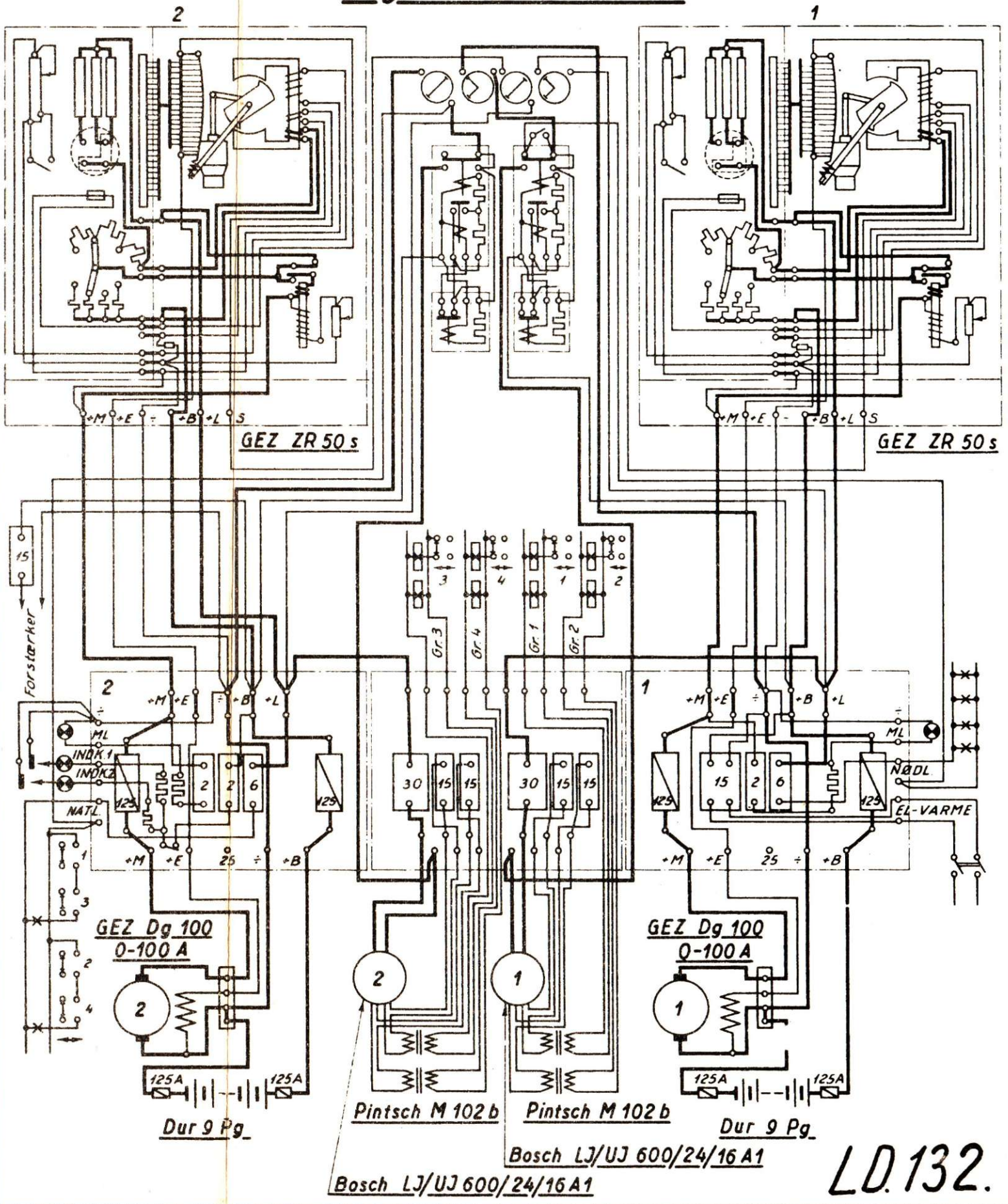

LD.132.

Li: 2 (A, E, F).
 LA: 2 (C, D).

Pintsch dynamo
Vogn ltr. Av nr.

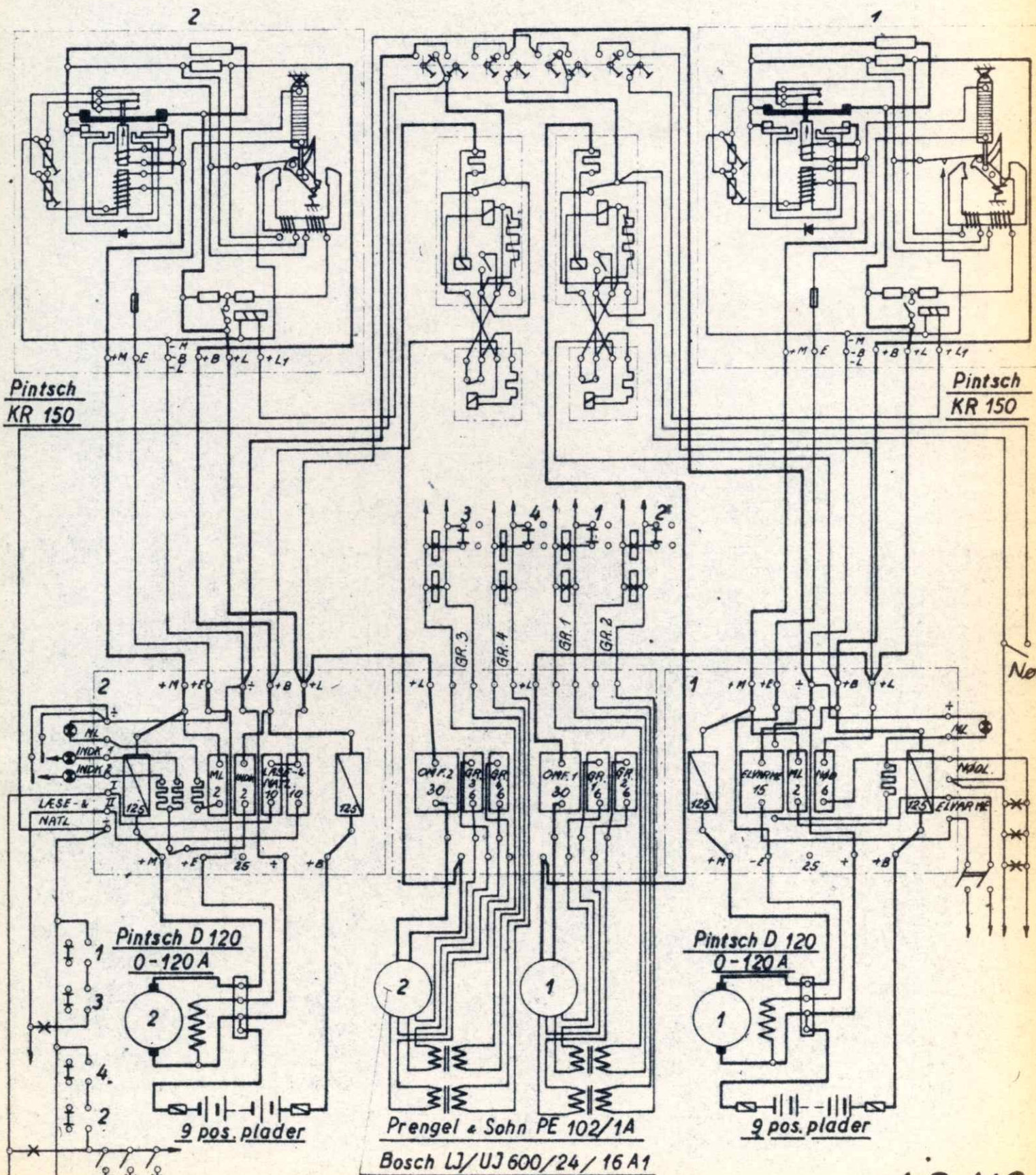

Nedb

100 Amp. dynamoanlæg m. lysrør.

Vogn ltr. _____ nr. _____

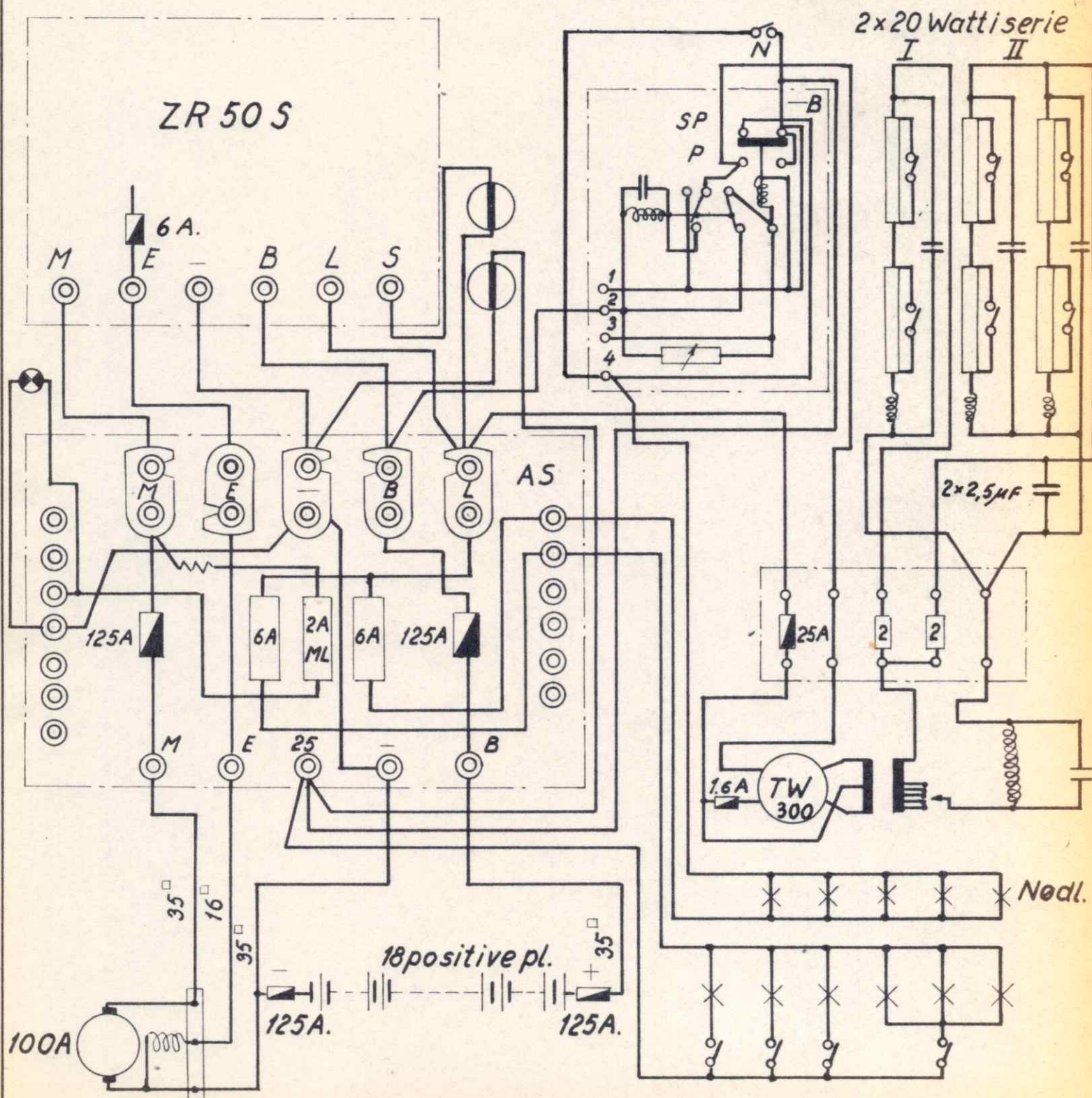

4 DK 11.200

Dynamoanlæg 120 A. m. lysrør Vognltr. nr. _____

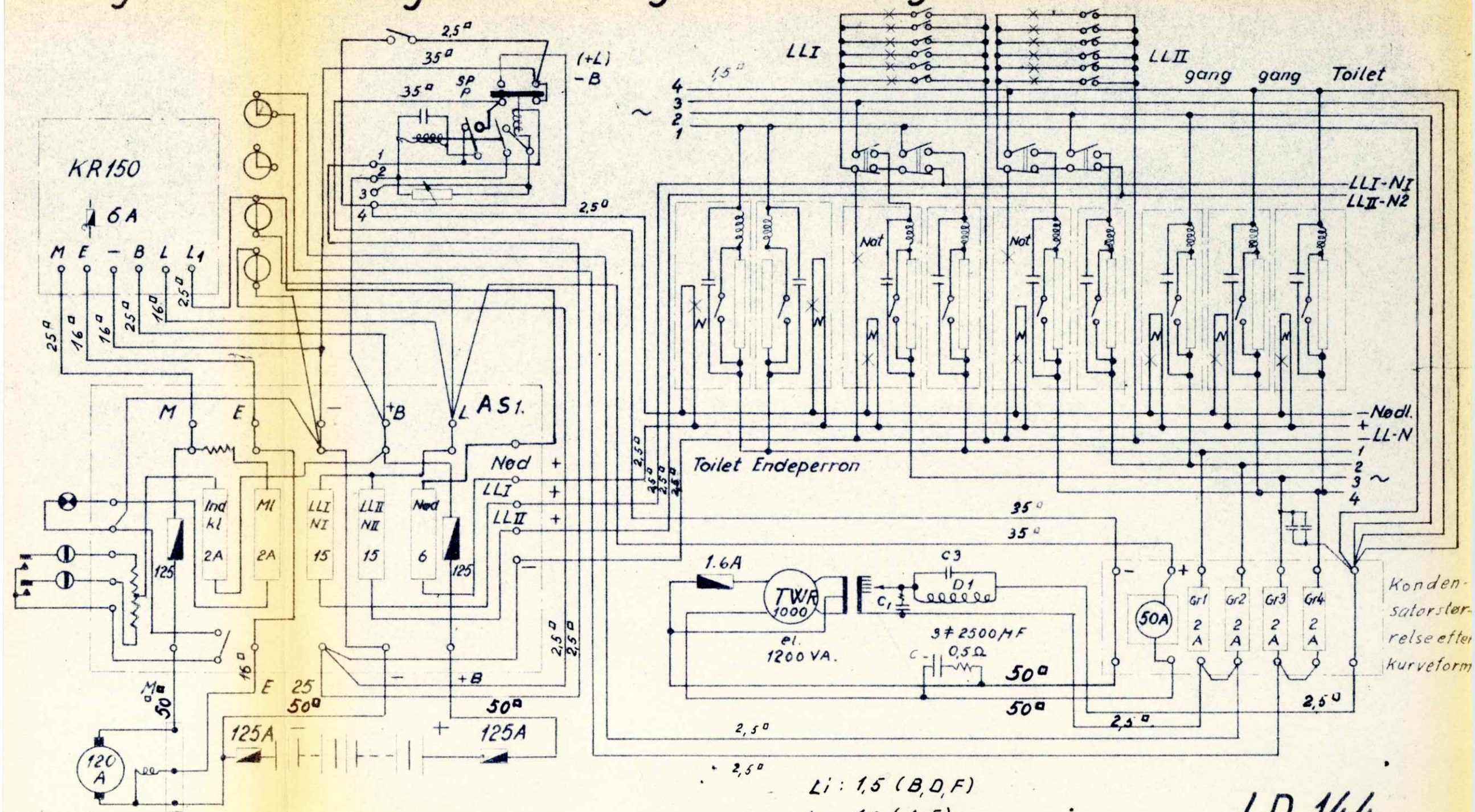

Rev 25/10-68

Li: 1,5 (B,D,F)
 LA: 1,6 (A,F)

LD. 144.

Konden-
 satorstør-
 relse efter
 kurveform

Dynamoanlæg 120 A. m. lysrør. Vognltr. nr.

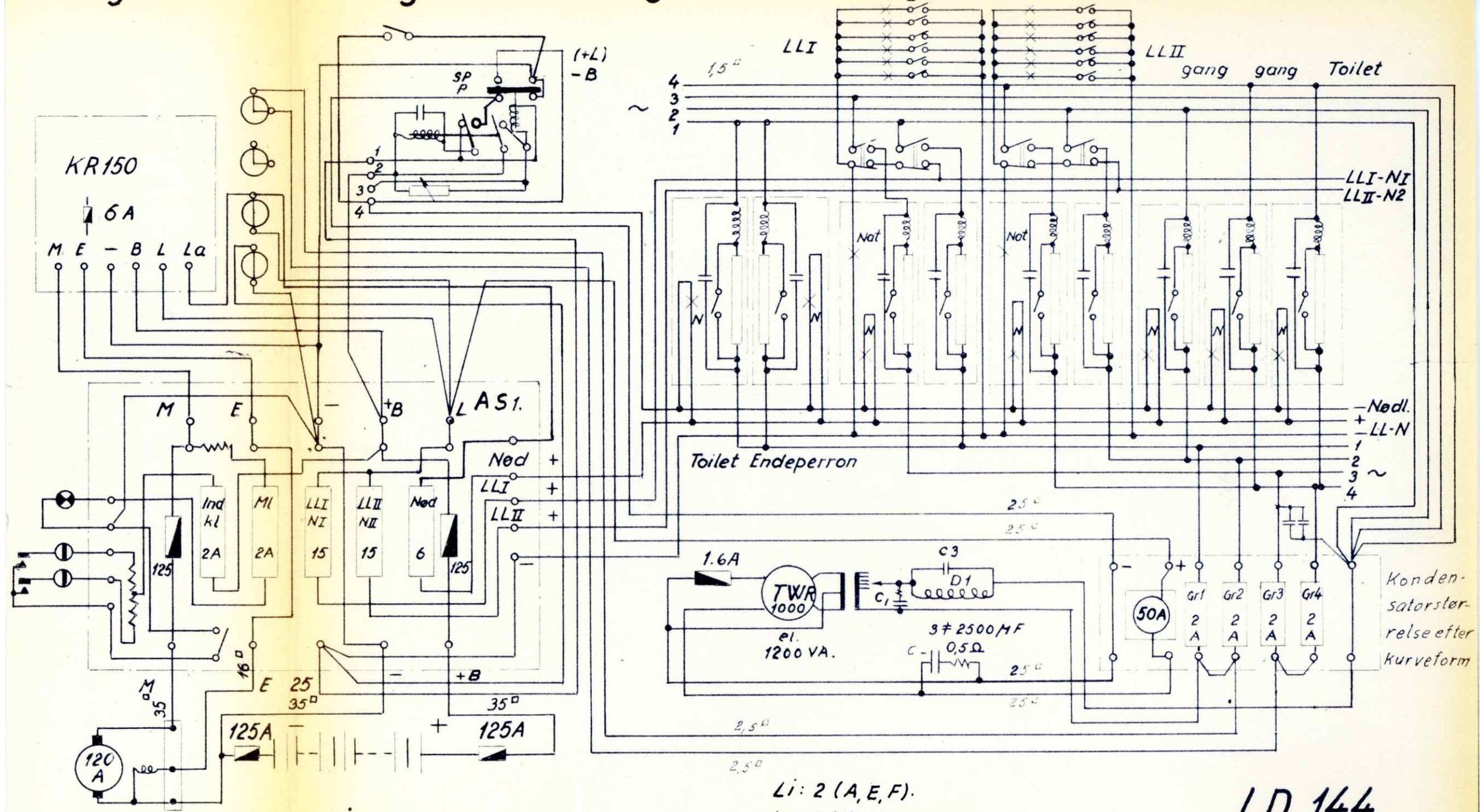

Li: 2 (A, E, F).
 LA: 2 (C, D).

LD. 144.

Li: 2 (A, E, F) }
 LA: 2 (C, D) } Av, AVL: 293-312.
 Li: 1,5 (B, D, F) }
 LA: 1,6 (A, F) } AVL: 241-255.

Pintsch dynamo

Vogn ltr. Av nr.

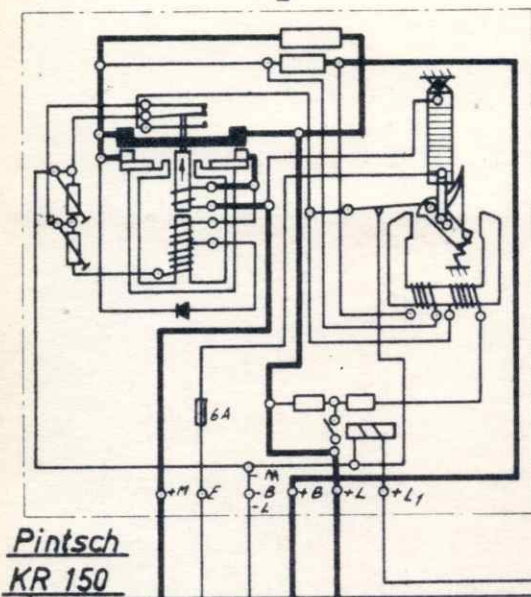

Pintsch KR 150

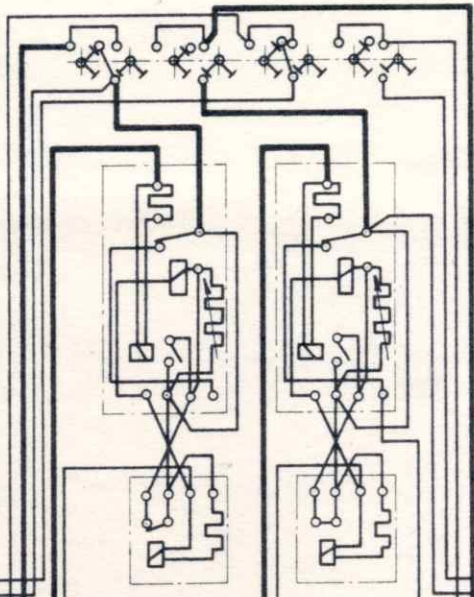

Pintsch KR 150

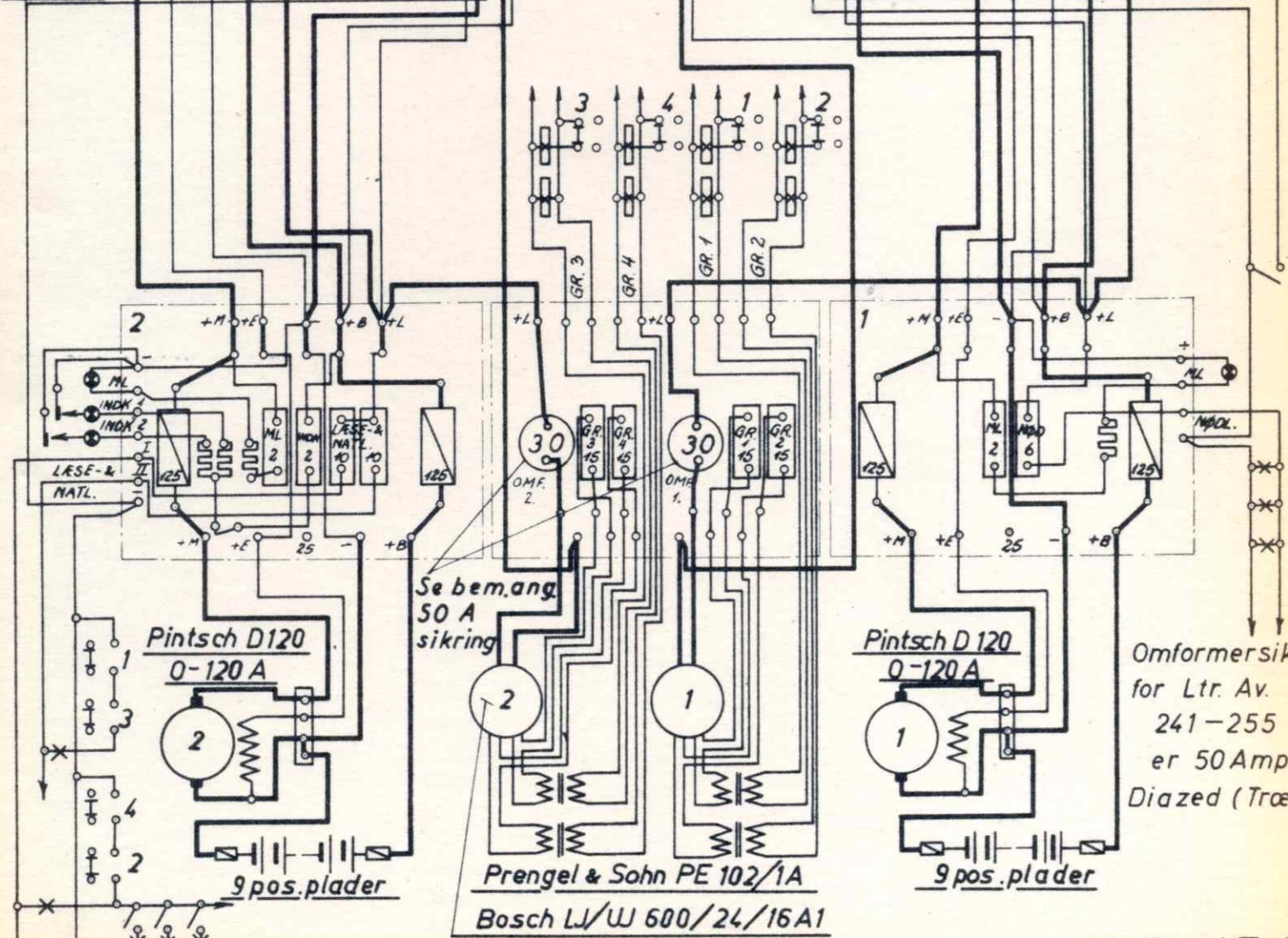
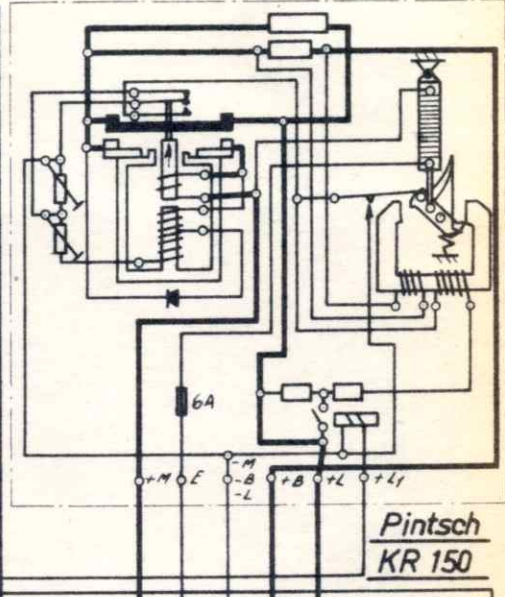

Pintsch D120 0-120 A

Pintsch D120 0-120 A

Se bemang 50 A sikring

Pregel & Sohn PE 102/1A
Bosch LJ/W 600/24/16A1

Omformersikring for Ltr. Av. 241-255 er 50 Amp. Diazed (Træg)

Dynamoanlæg 120 A. m. Lysrør.

Vognltr.

Nr.

Kupeer I Kl.

Kupe: I Kl.

Kupe: I Kl.

Sidegang og toiletter.

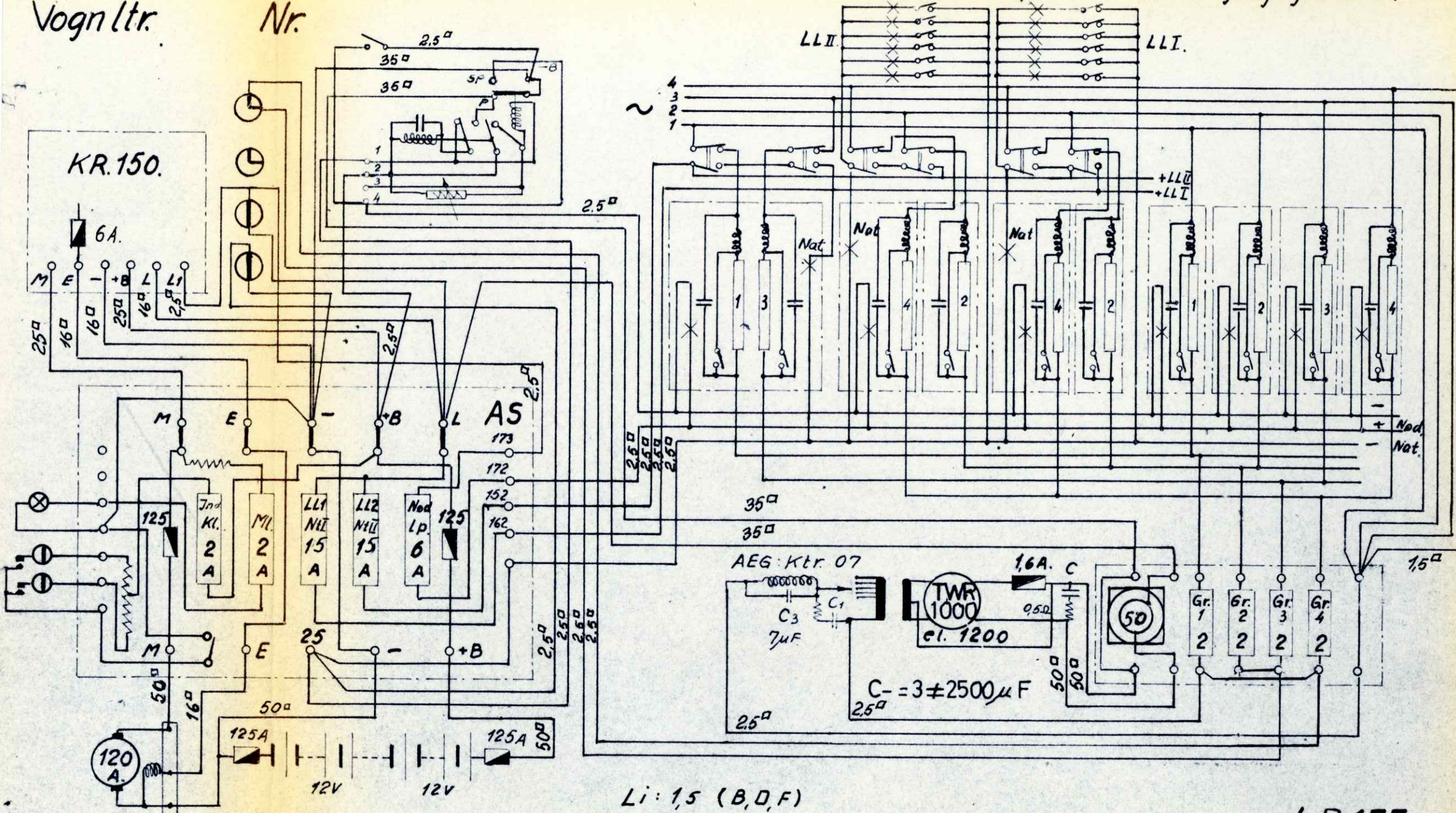

Li: 1,5 (B, D, F)

LA: 1,6 (A, F).

LD.155.

Dynamoanlæg 120 A. m. Lysrør.

Vognltr. Ax. Nr. _____

Kupeer I Kl. Kupe: I Kl. Kupe: I Kl. Sidegang og toiletter.

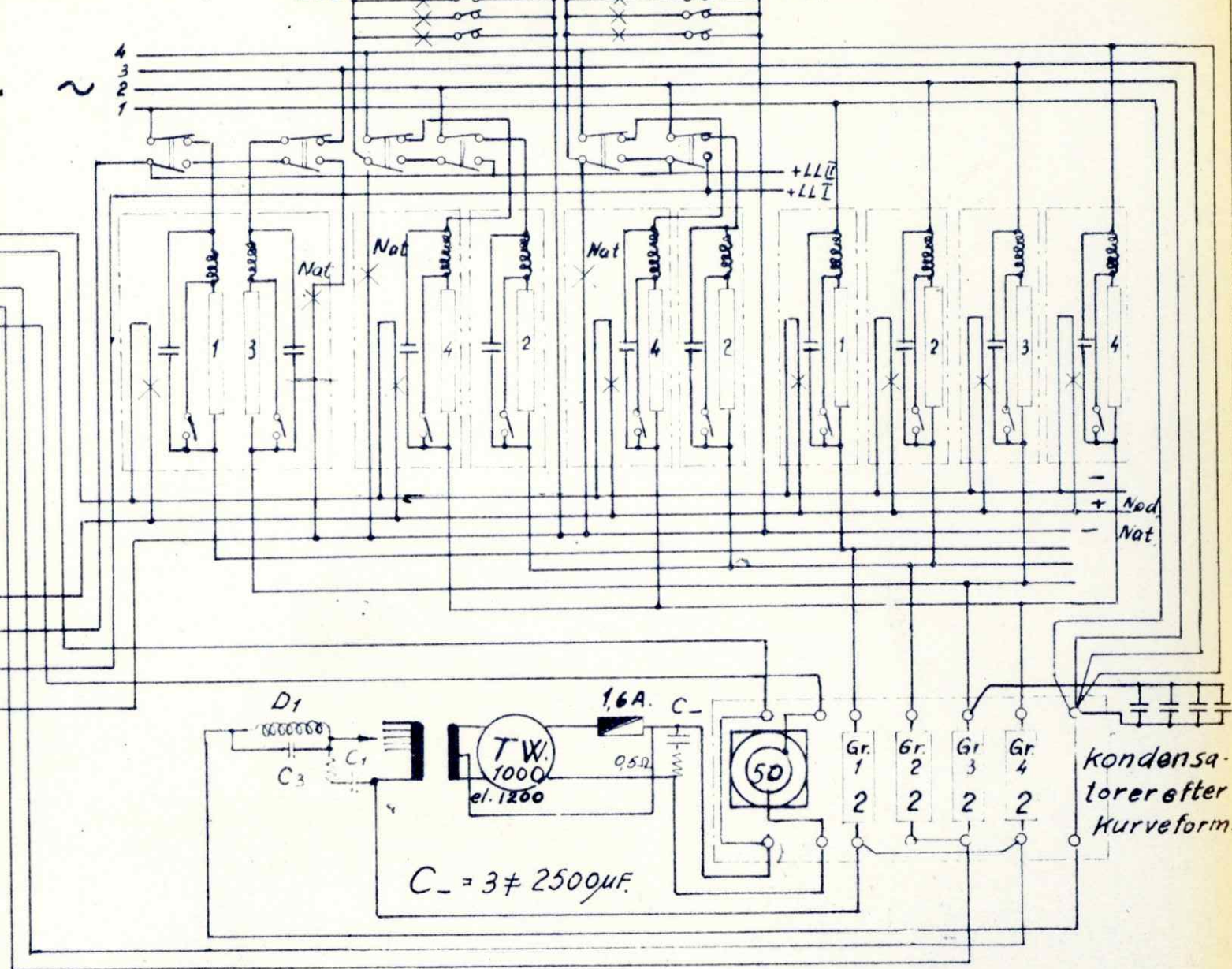
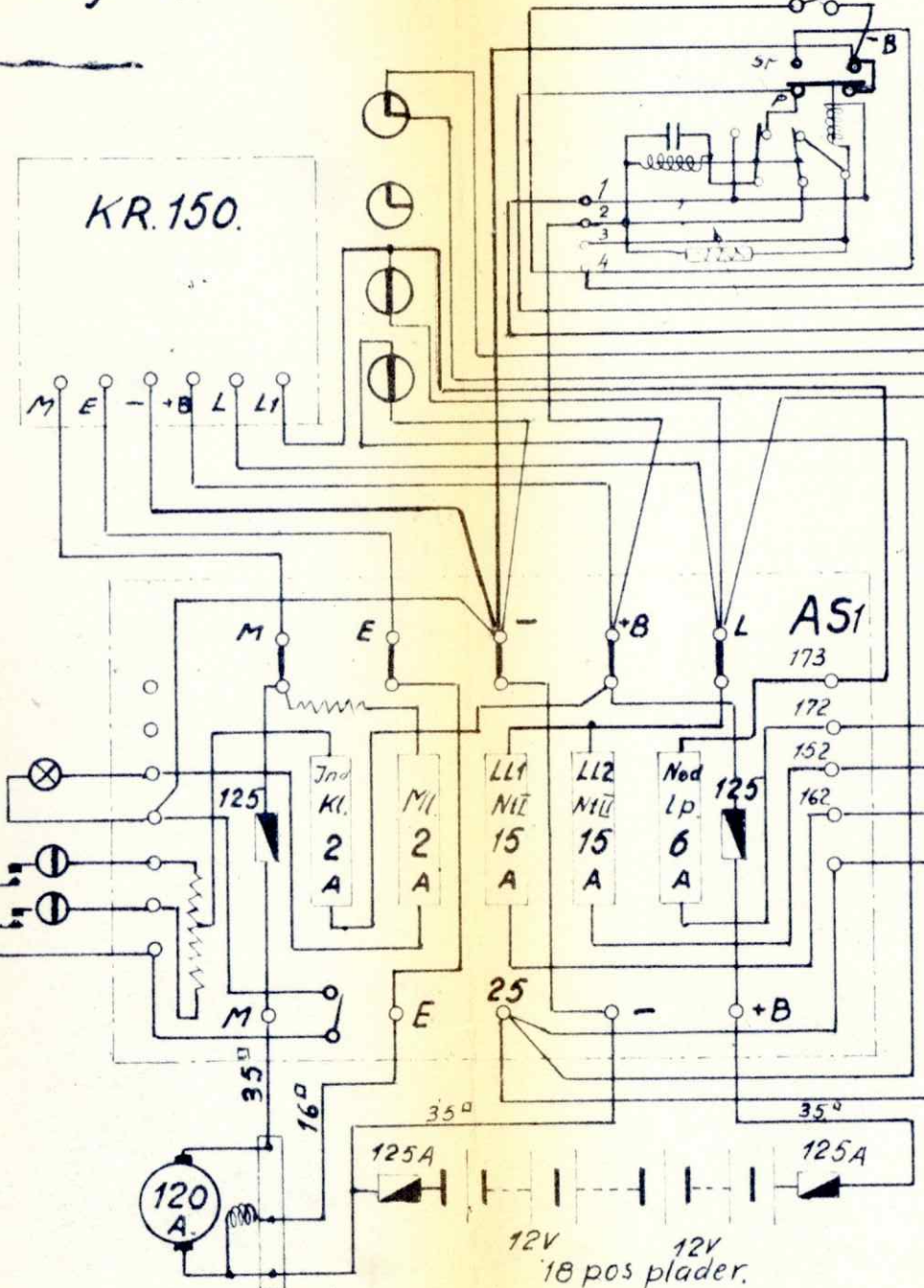

Li: 2 (A,E,F) } Ax: 391, 392, 396, 397. Li: 1,5 (B,D,F) } Ax: 393, 394. LD. 157.
 LA: 2 (C,D)

Li: 2,5 (A, D, F). KR. 150.
 LA: 12 (A, D)

Pintsch dynamo

Vogn ltr. Cle nr.

Pintsch KR 150

Ved regul. skab GEZ: ZR 50 S forbindes ledning L1 til klemme 5.

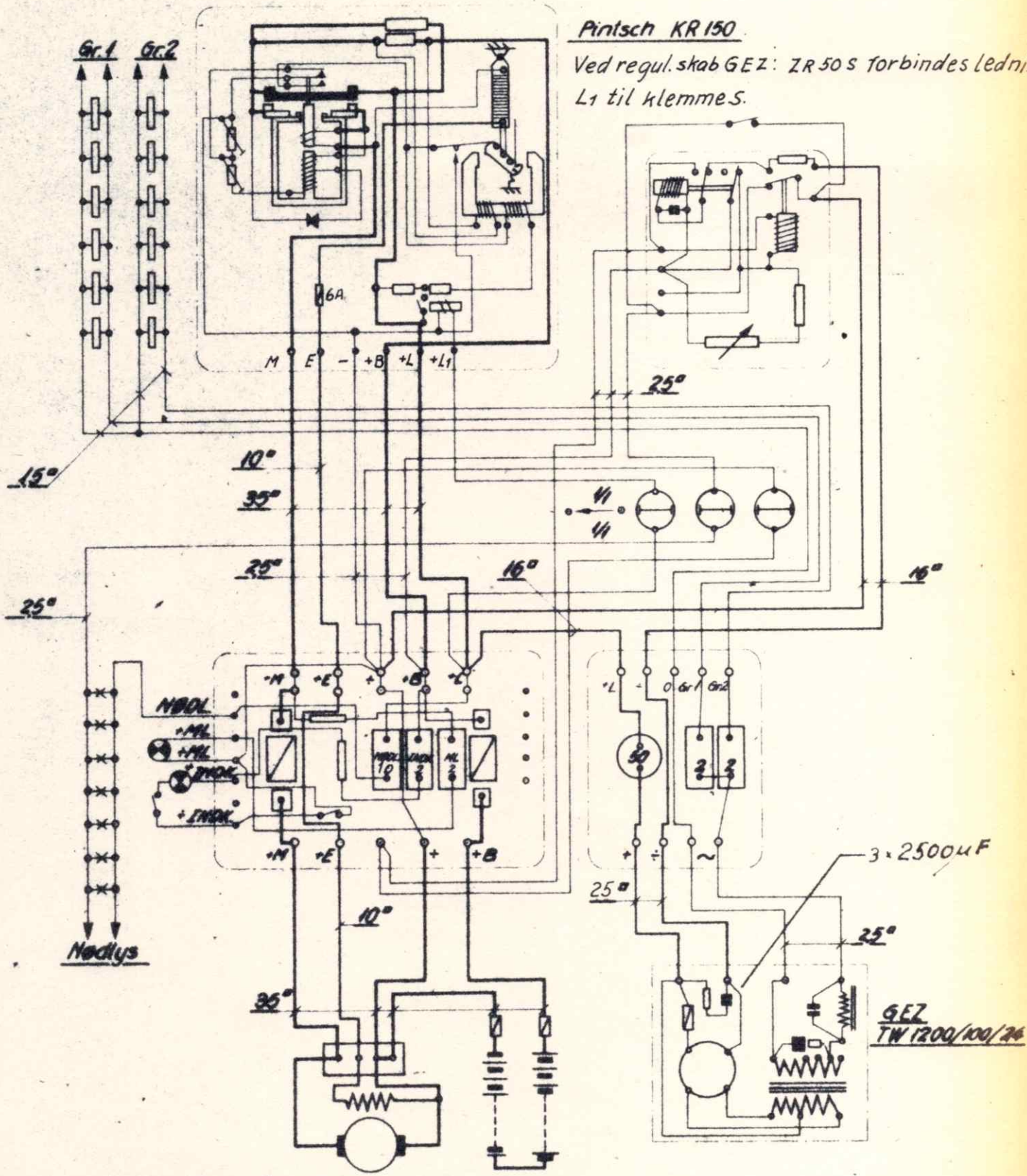

Pintsch D-120

10 pos. plader

LD.161.

Krupp generator

Vogn ltr. B nr.

Krupp SPB 475

Krupp LR73ZD79KSI

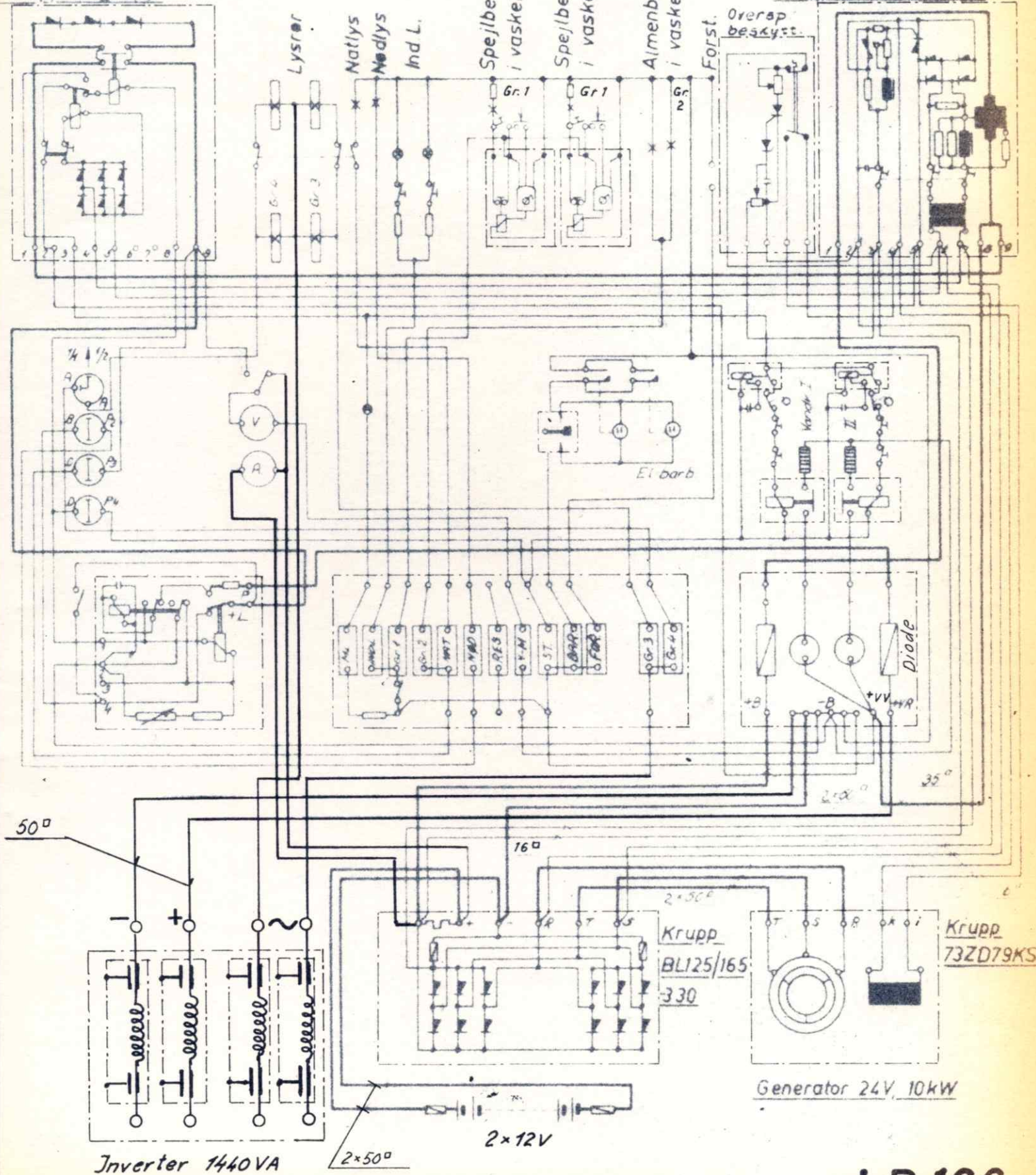

50[□]

16[□]

35[□]

Inverter 1440VA

2x12V

Generator 24V, 10kW

Krupp
BL125/165
330

Krupp
73ZD79KS

Krupp generator Vogn ltr. B nr.

Krupp SPB 475

Krupp LR73ZD79KSt

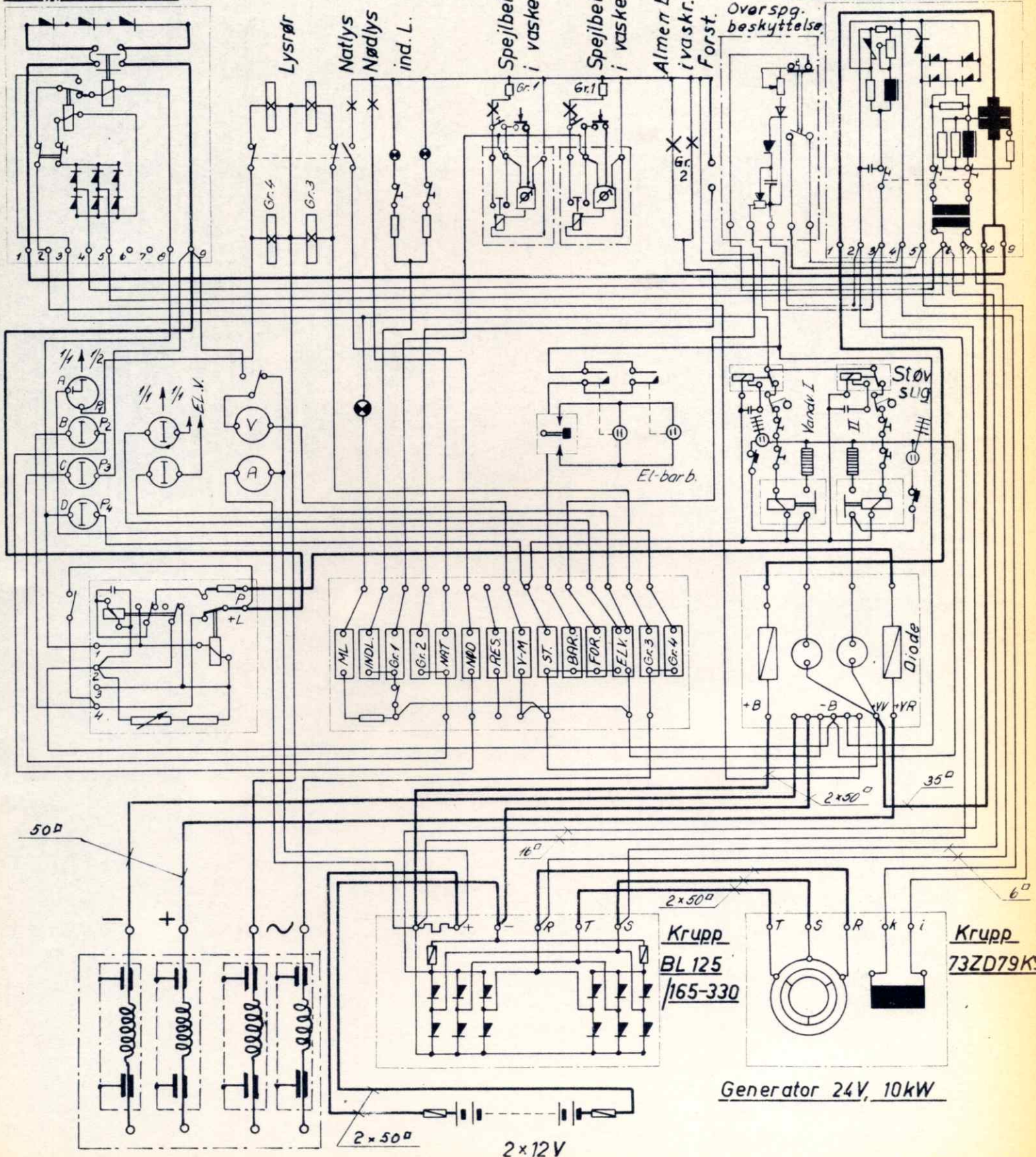

Inverter 1440 VA

Generator 24V, 10kW

LD.167.

Dynamoanlæg 120 Amp. m. Lysrør. Vogn Ltr. Nr.

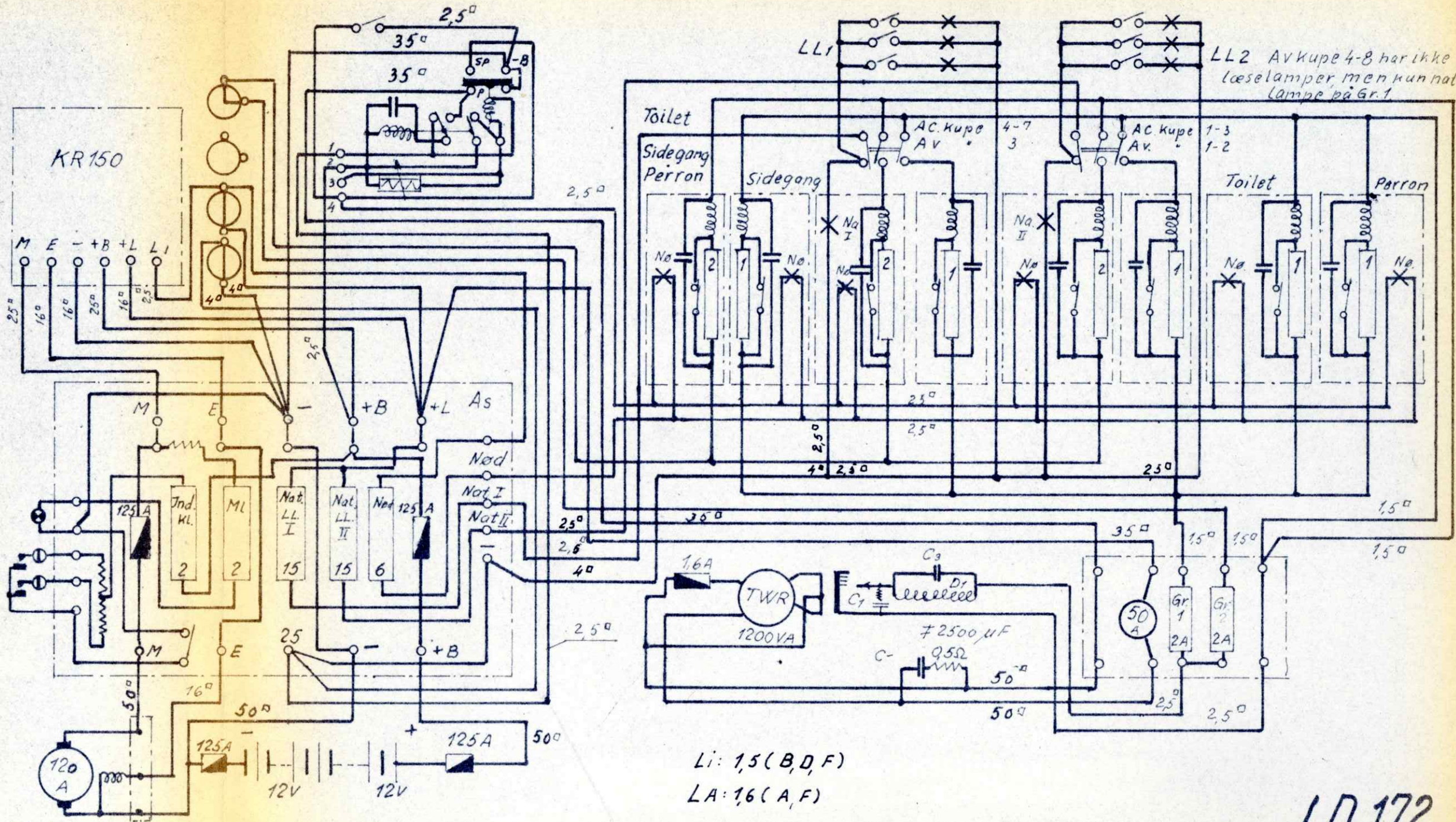

LD.172.

Dynamoanlæg 120Amp m. lysrør Vognltr. Nr.

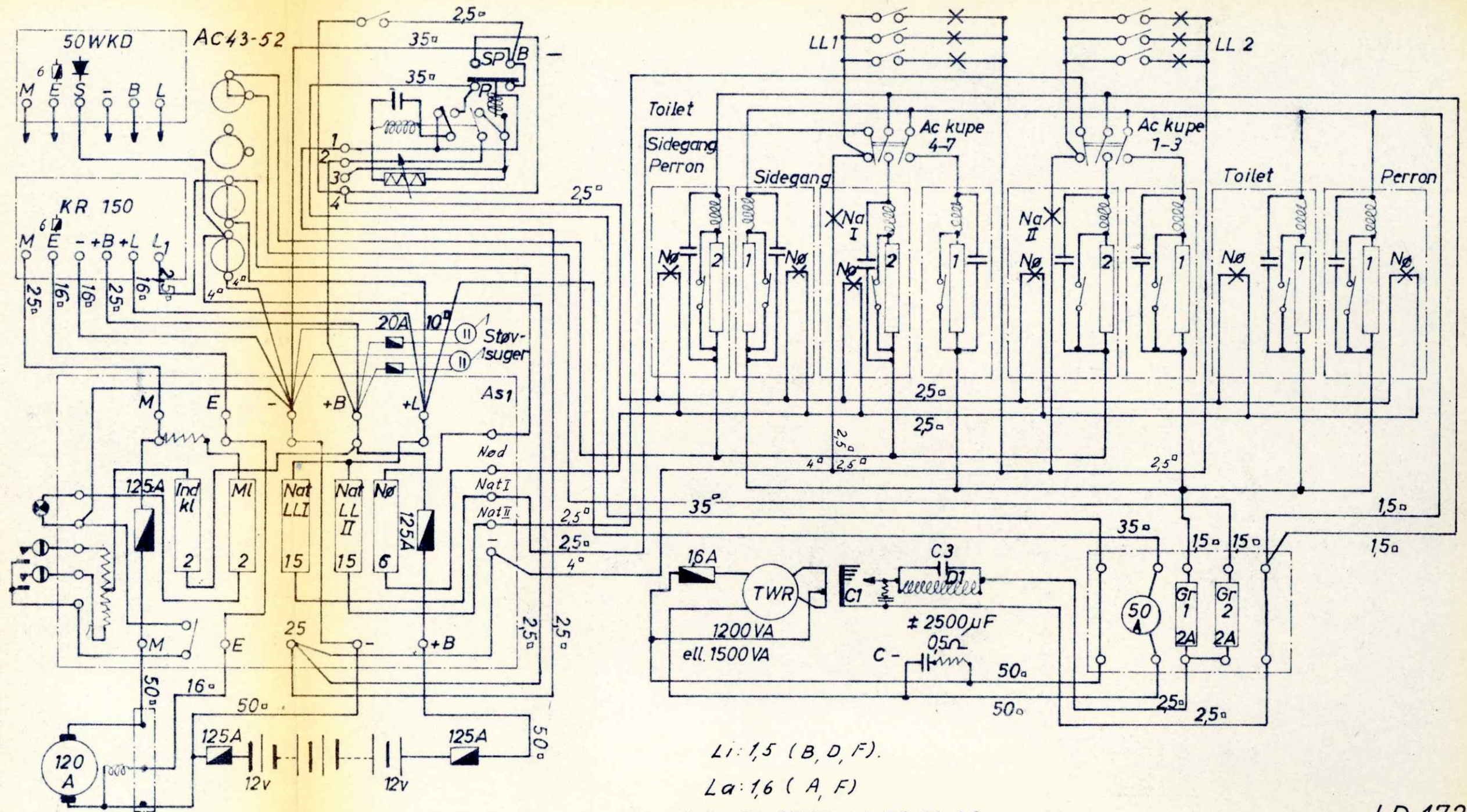

Krupp generator Vogn ltr. A nr.

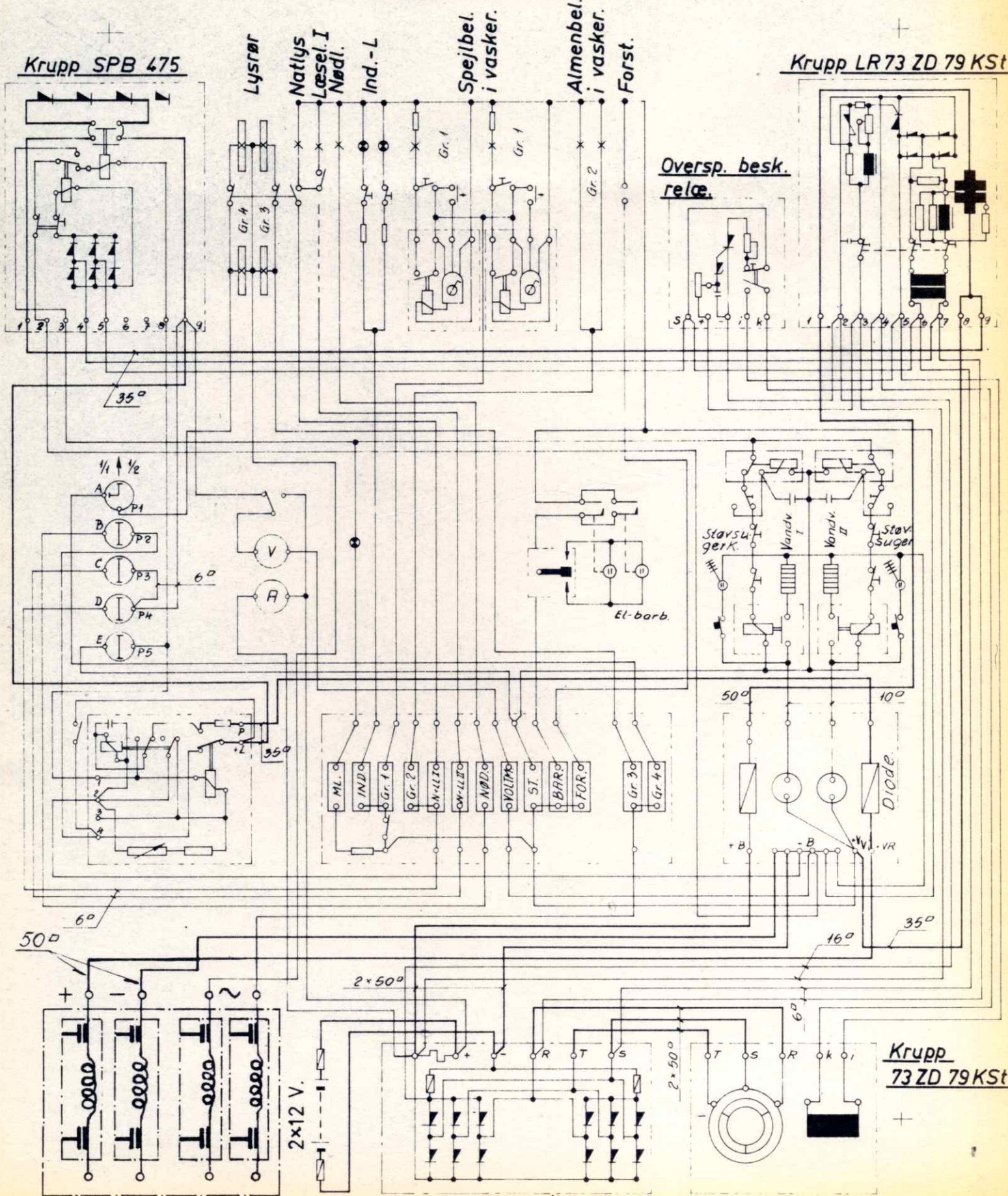

Krupp SPB 475

Krupp LR73 ZD 79 KST

Over-sp. besk. relæ.

Inverter 1440 VA

Krupp BL 125/165-330

Krupp 73 ZD 79 KST

Rev 24-2-69

Pintsch Dynamo. Vogn Ltr. C.D.Nr.

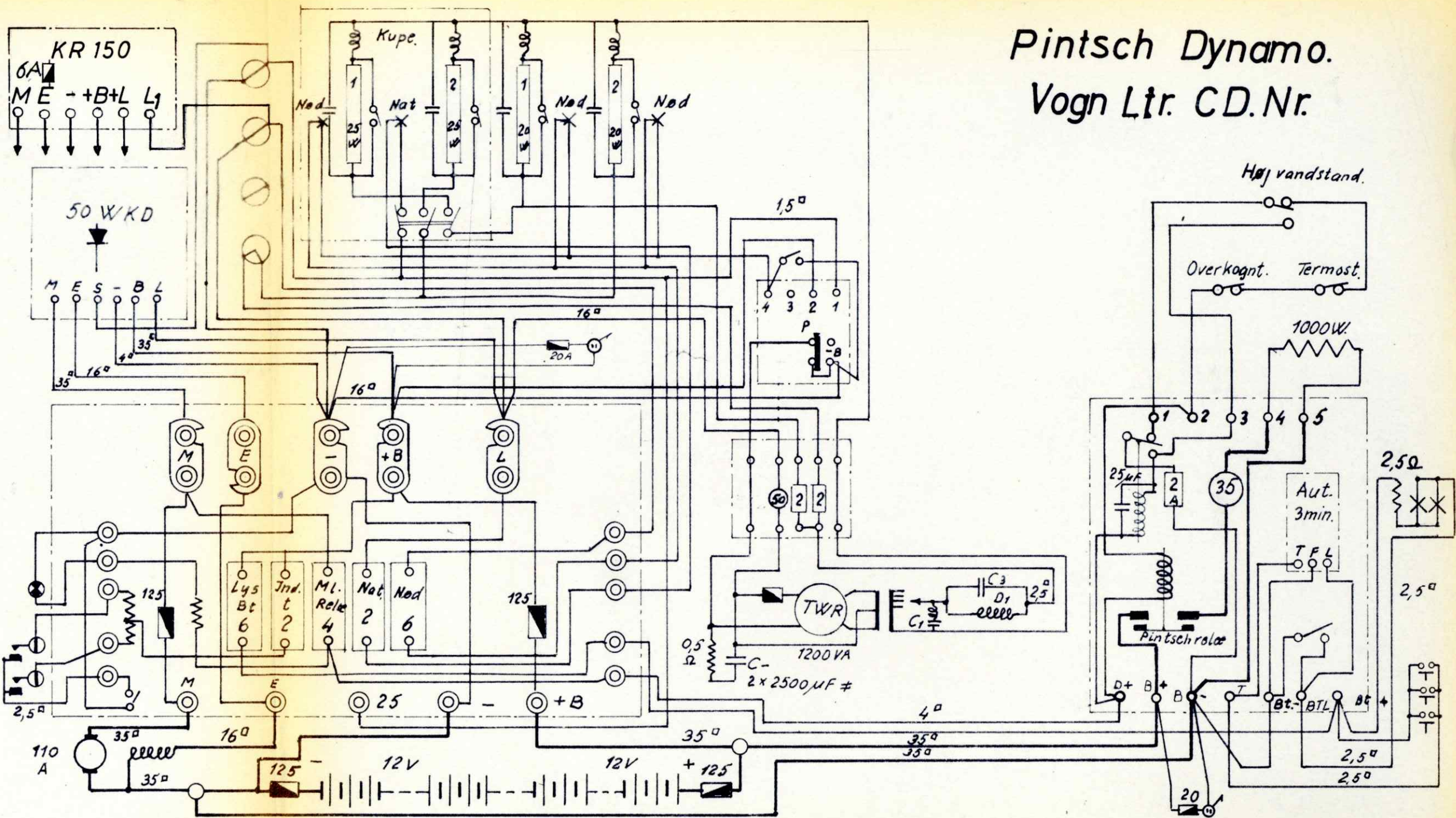

Dynamo anlæg 120 amp. m. lysrør. vogn ltr. nr.

KR.150.
 Li: 1,5 (B,D,F).
 LA: 1,6 (A,F)

M E - +B +L L1

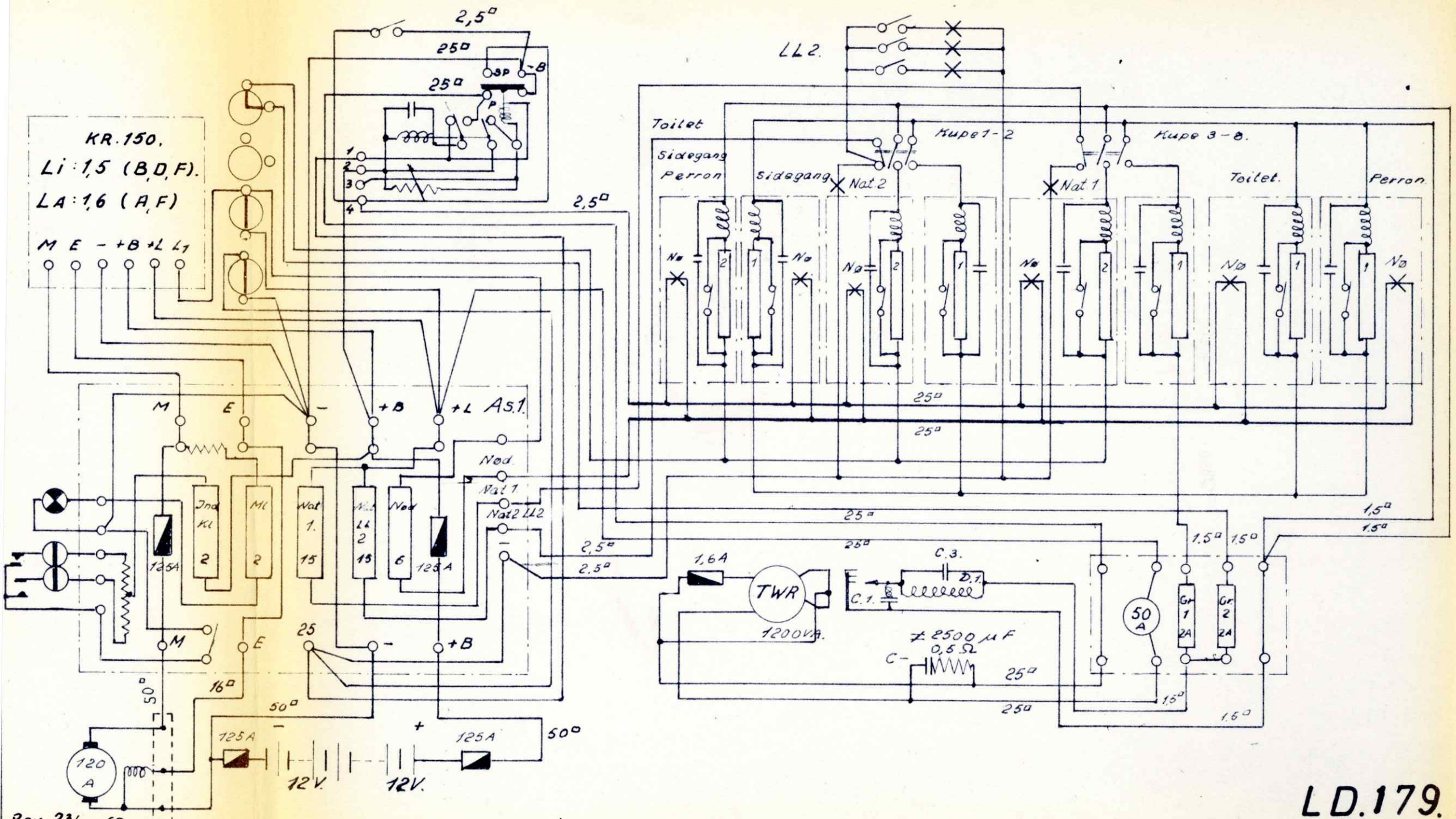

KRUPP GENERATOR

VOGN ltr. DM nr.

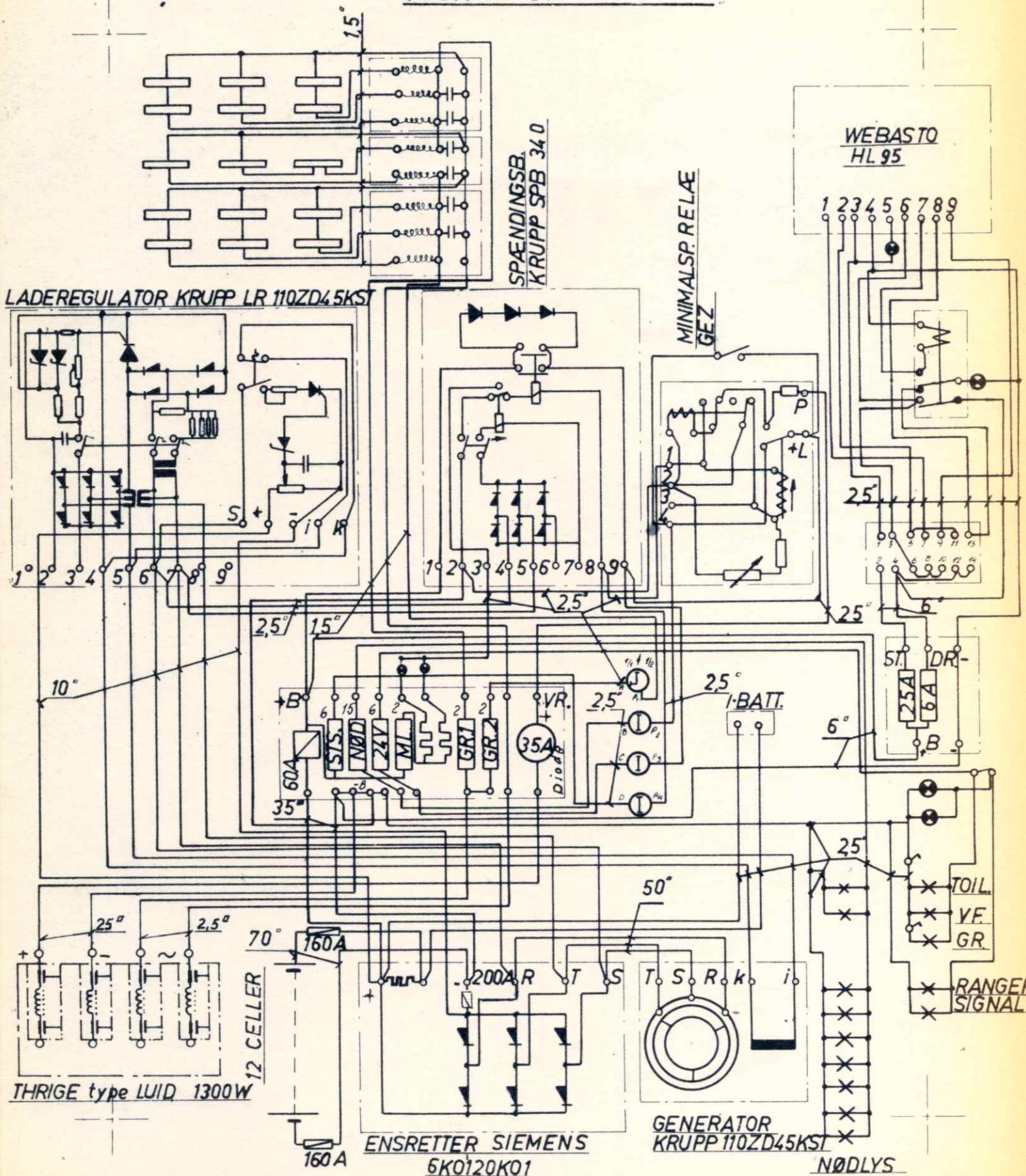

Krupp generator

Vogn ltr. BD nr.

Krupp SPB 475

Krupp LR 73 ZD 79 KSt

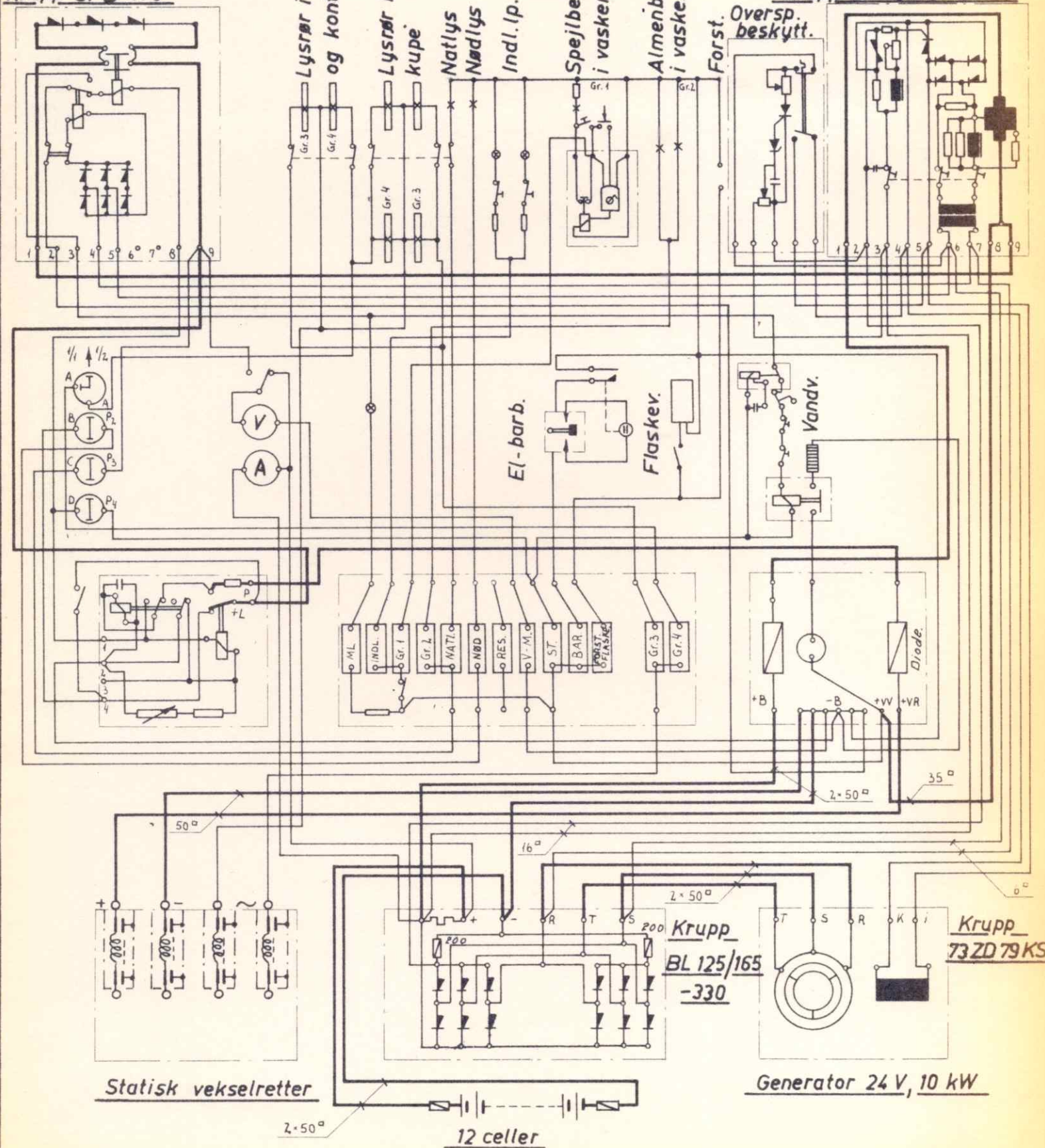

KRUPP GENERATOR

Vogn ltr. P nr. _____

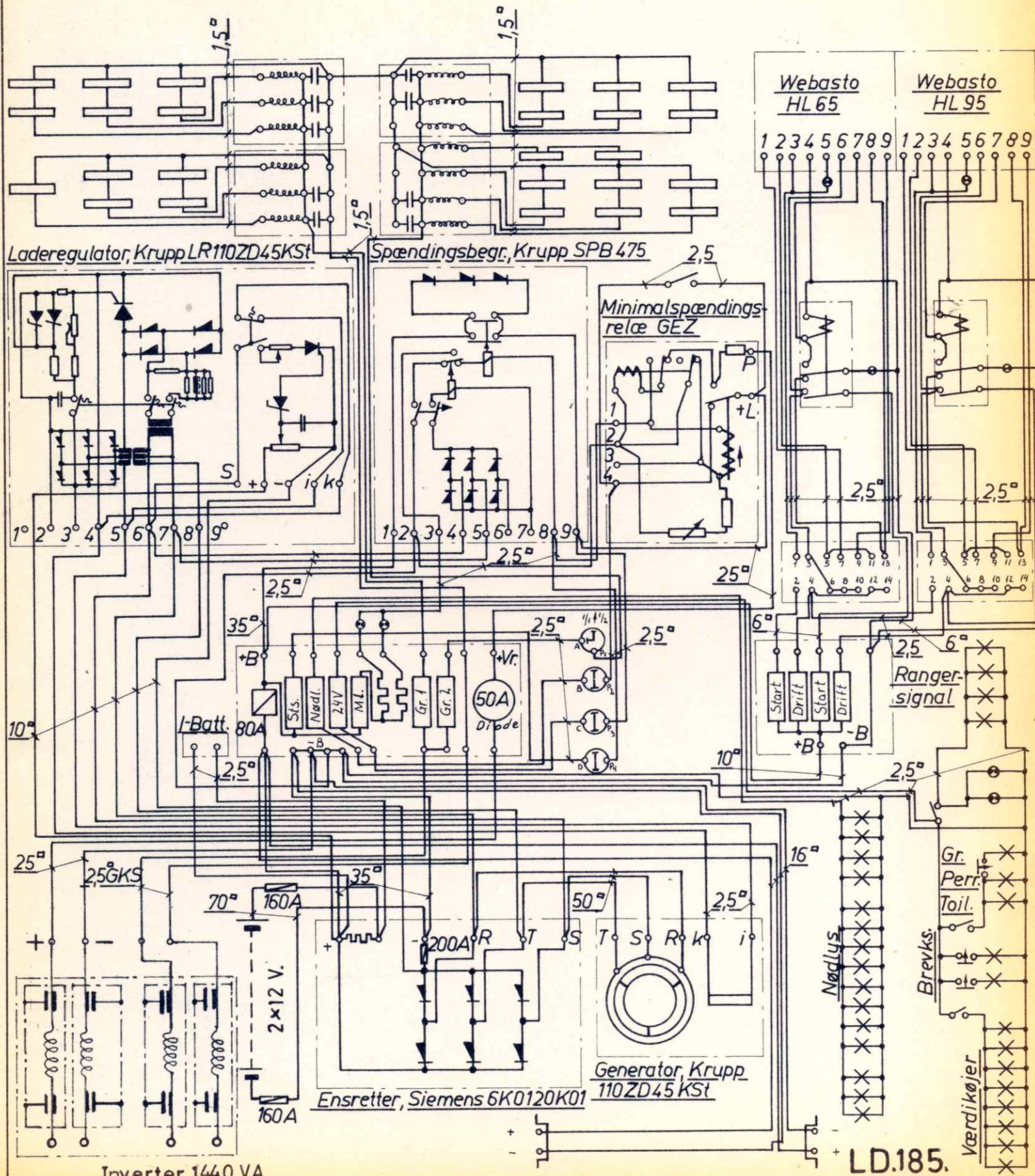

KRUPP GENERATOR.

VOGN Ltr. Pf.

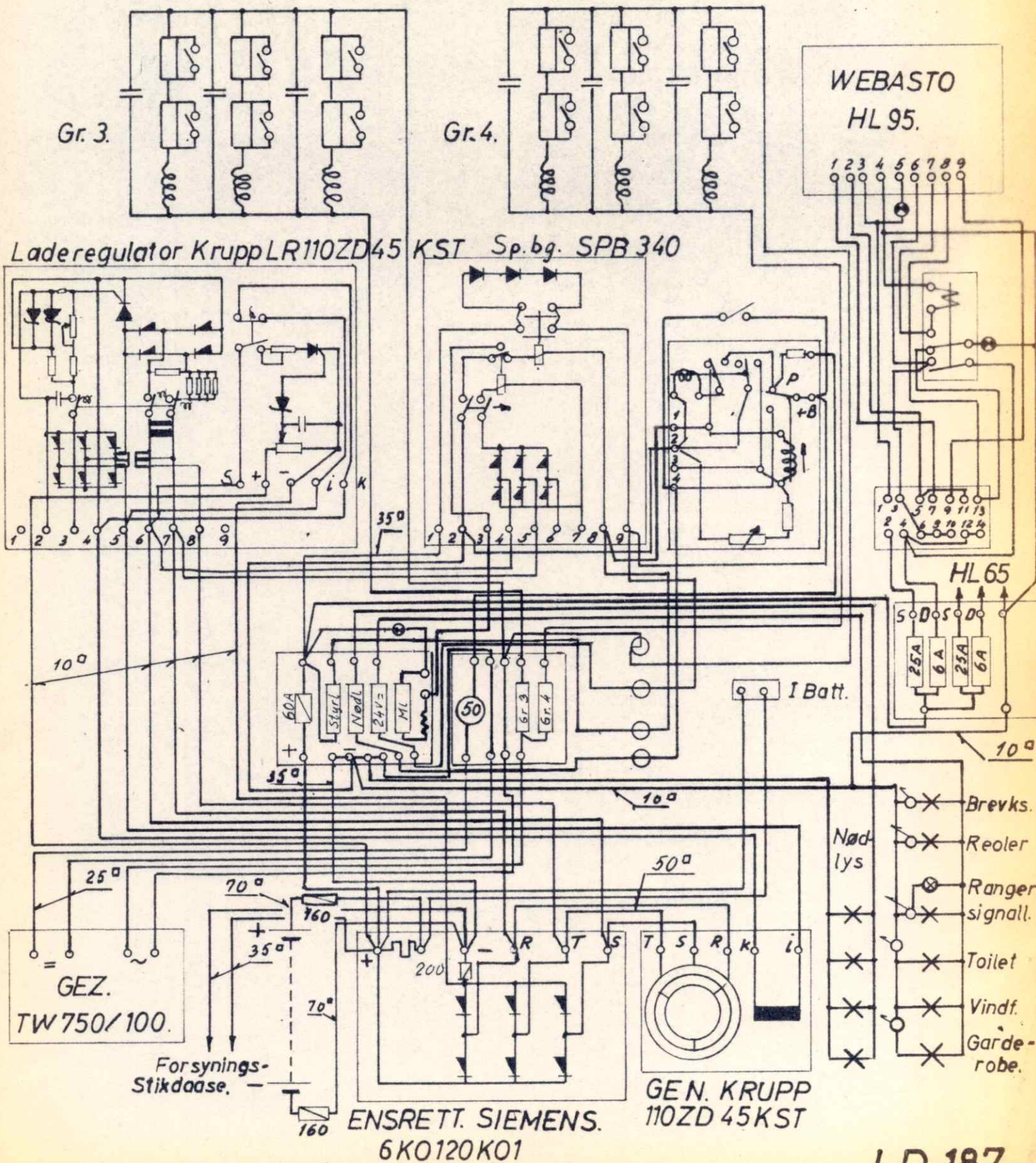

Dynamoanlæg 100 Amp. med Lysrør Vogn Ltr. B.G.C. Nr.

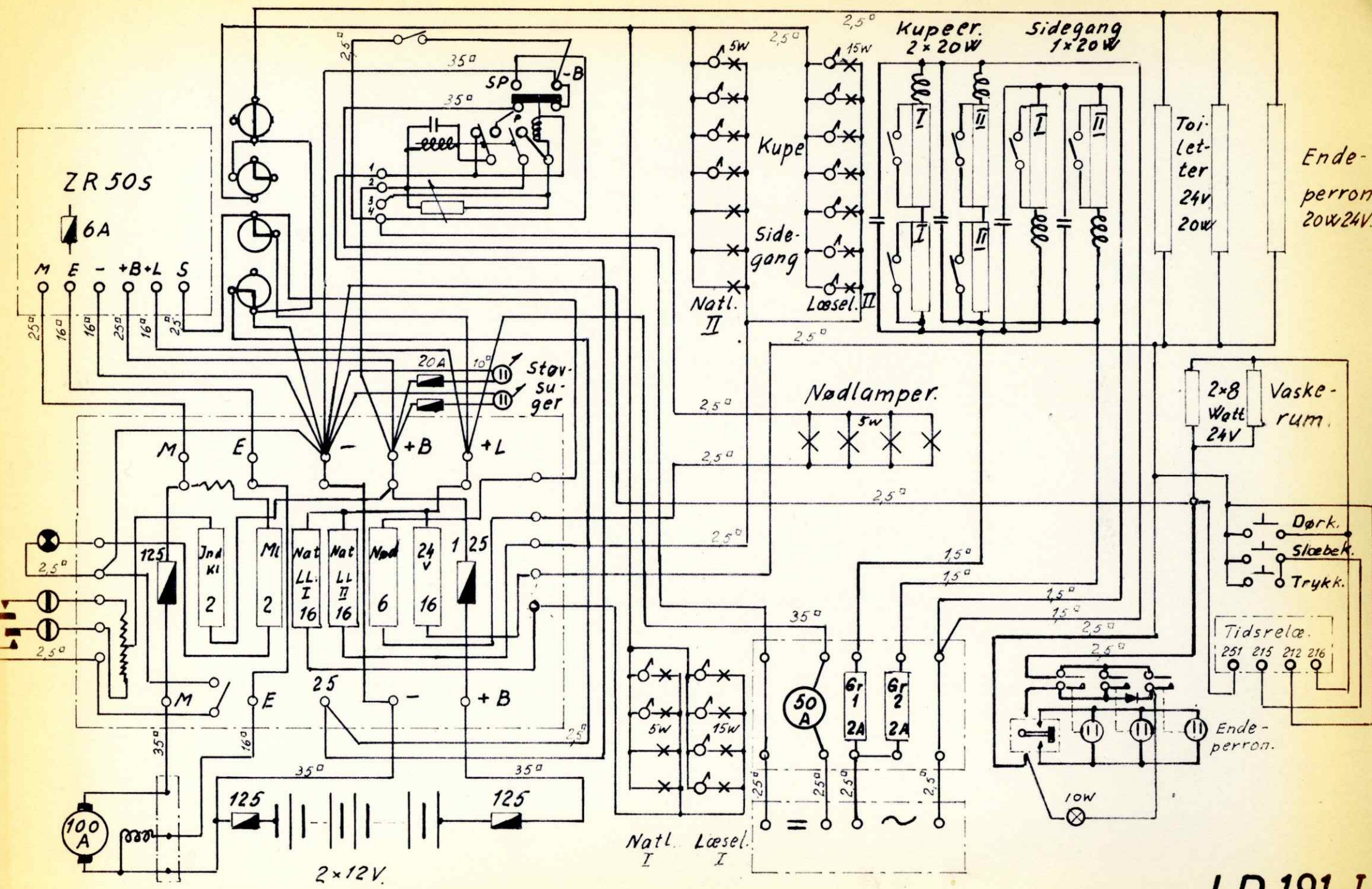

LD.191-I.

Dynamoanlæg 120Amp m. lysrør Vognltr.

Nr.

Li : 1,5 (B,D,F).
La : 1,6 (A,F).

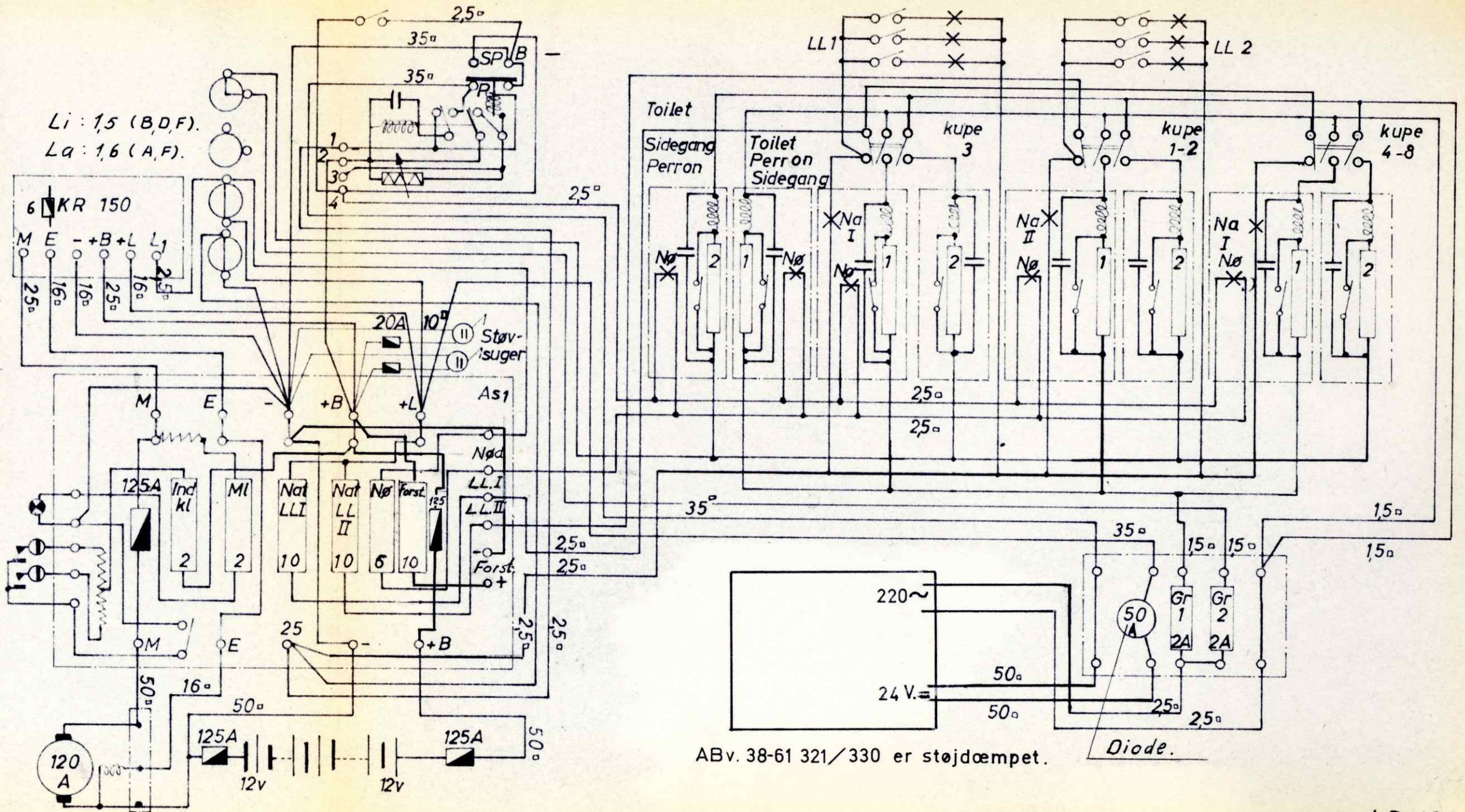

ABv. 38-61 321/330 er støjdæmpet.

Diode.

Dynamoanlæg 100 Amp. m. Lysrør. VognLtr. Nr.

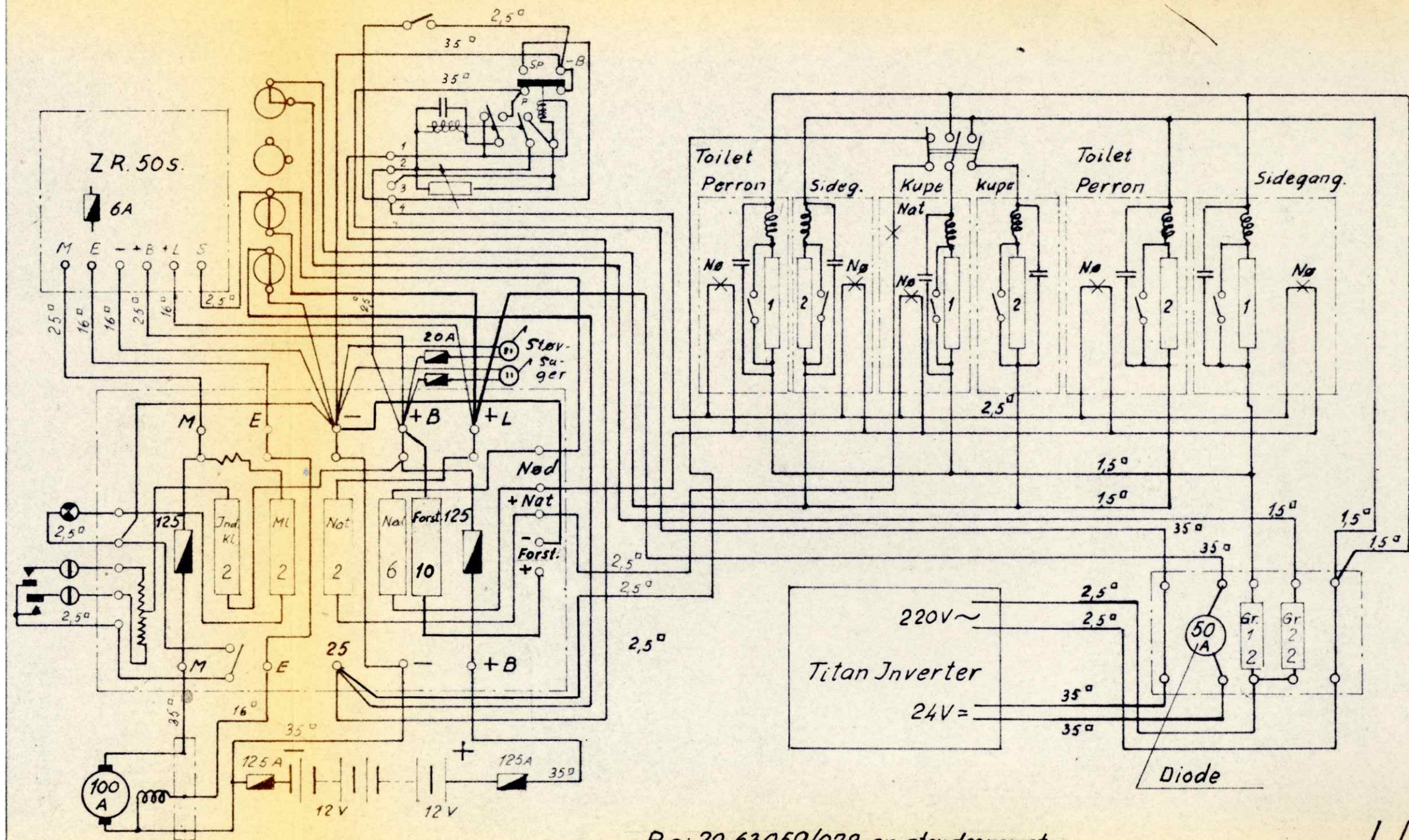

Bg: 29-63059/078 er støjdæmpet.

LD. 194