

B. Kruse

11

JERNBANESKOLEN.

Januar 1959.

MAGNETISME og ELEKTRICITET.

---

---

TEGNINGER.

---

---

---oooOooo---



1. Magnetisme (Opmindelen) (Kampas)
2. Elektricitet og elek. maaleenheder
3. Stømmens varmevirkning del a. svingning
4. Stømmens magnetiske virkning
5. Induktion.
6. Dynamo
7. Motoren
8. Hoveddele i el. mask.
9. el. Maaleinstrumenter
10. Akkumulator



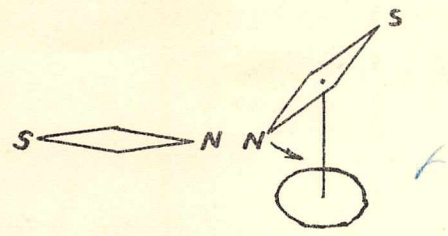

Fig. 1

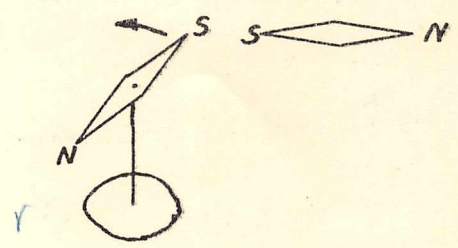

Fig. 2

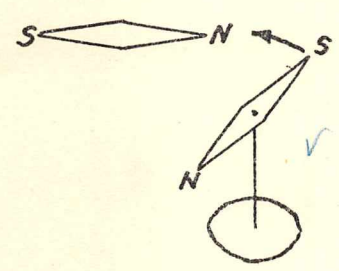

Fig. 3

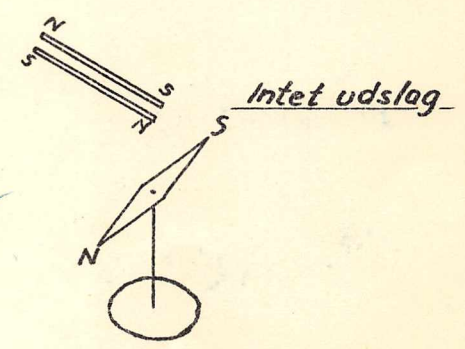

Fig. 4

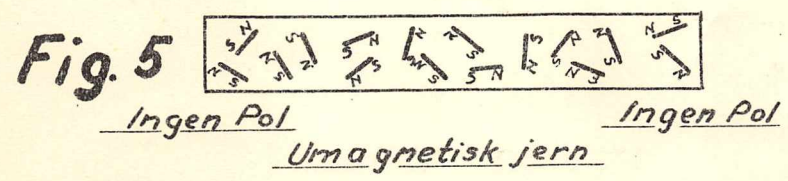

Fig. 5

Ingen Pol Ungagnetisk jern Ingen Pol

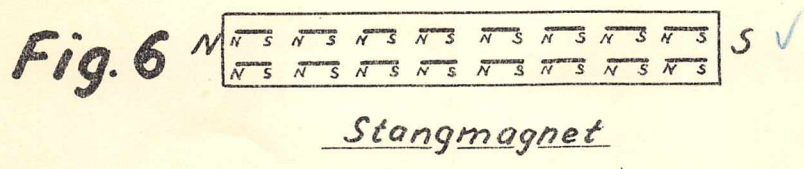

Fig. 6

Stangmagnet

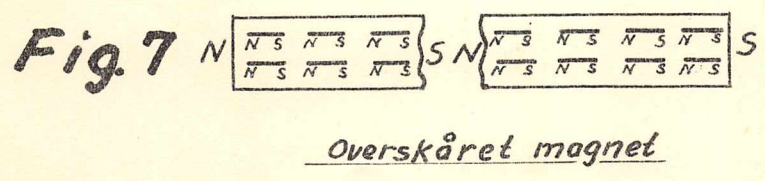
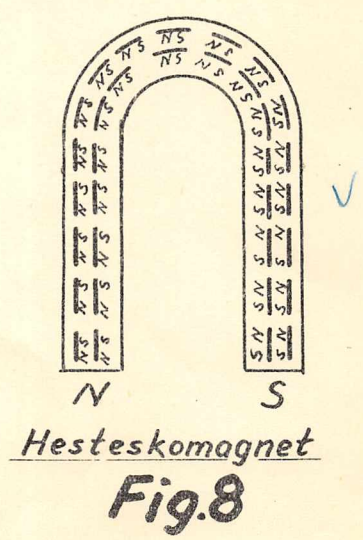

Fig. 7

Overskåret magnet



Hesteskomagnet

Fig. 8

Magnetisme og elektricitet.



I

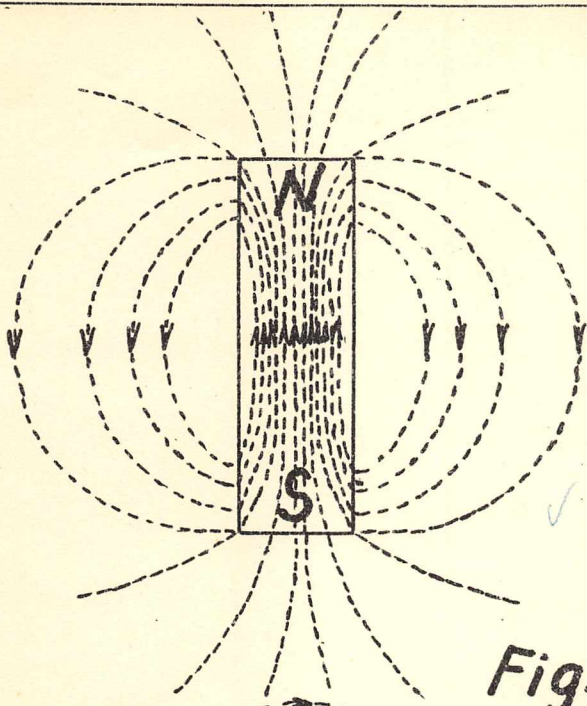

Fig. 9

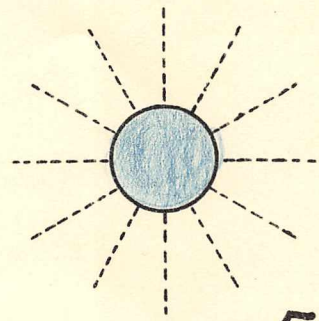

Fig 10

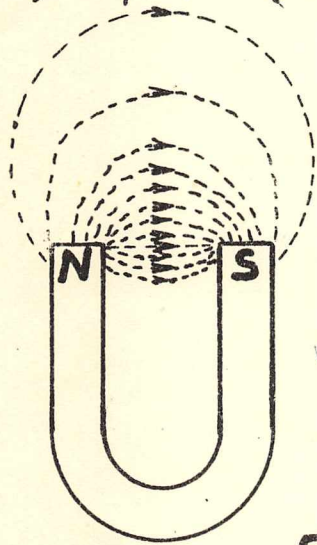

Fig. 11

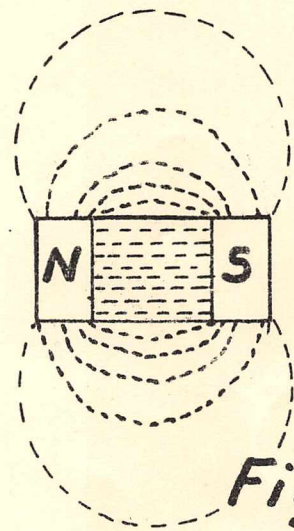

Fig. 12

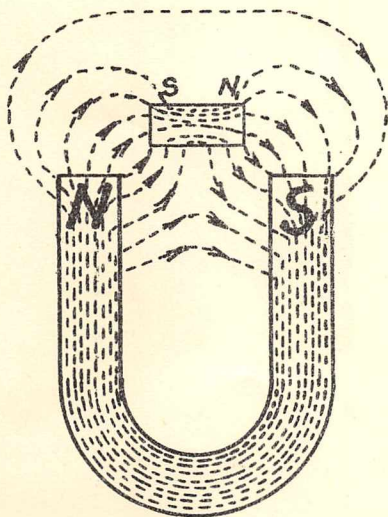

Fig. 13

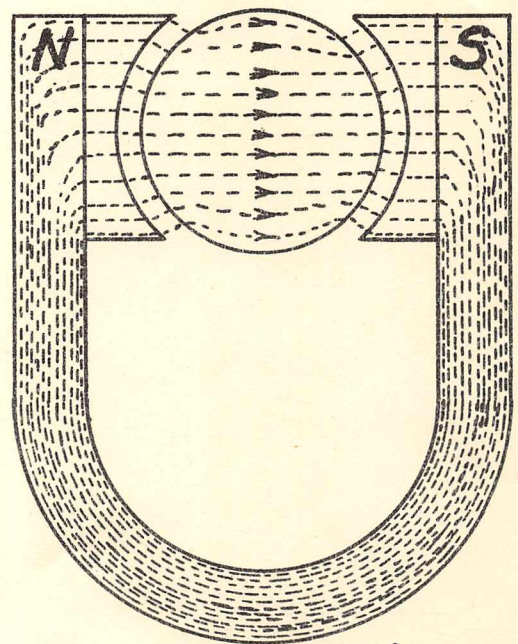

Fig. 14



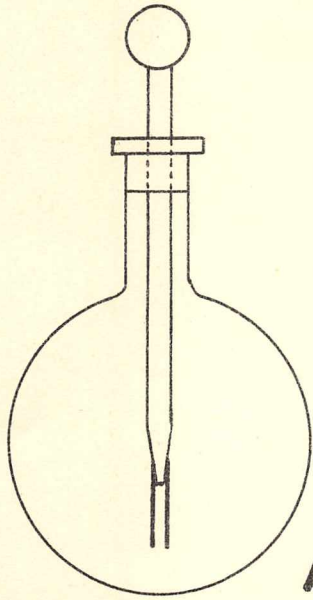

Fig. 15

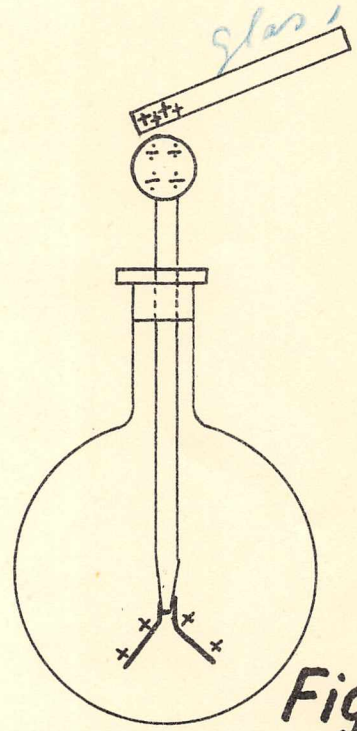

Fig. 16

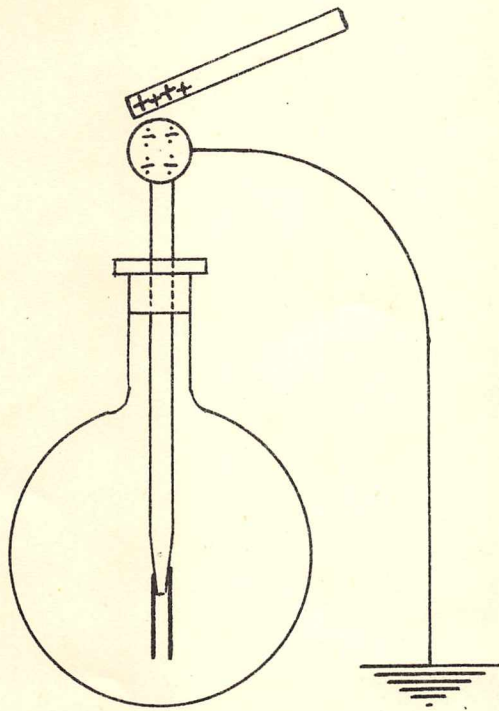

Fig. 17

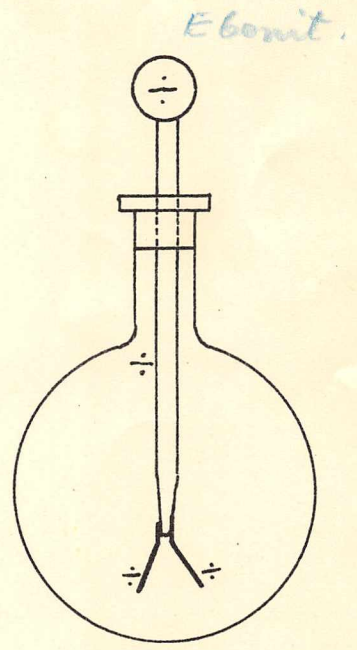

Fig. 18

Magnetisme og elektricitet.



II  
III

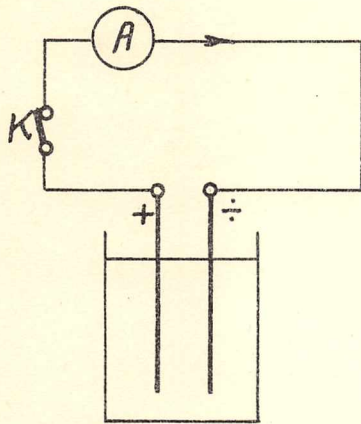

Fig. 19

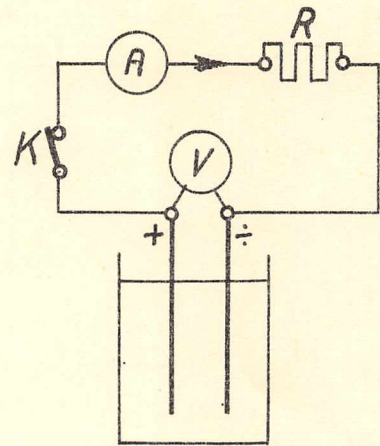

Fig. 20

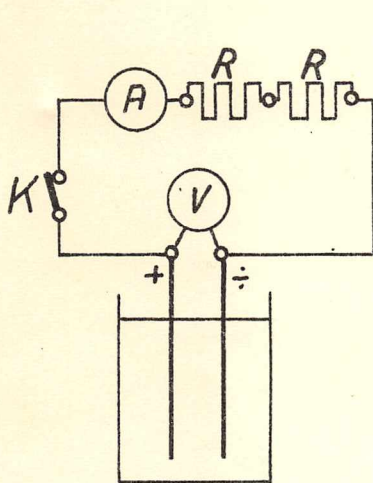

Fig. 21

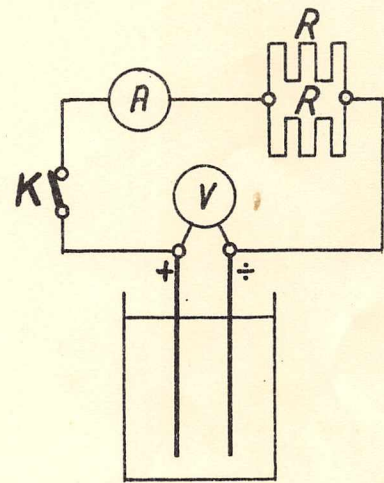

Fig. 22

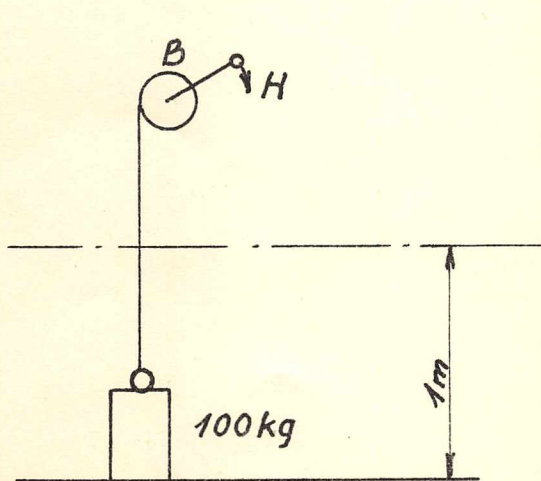

Fig. 23

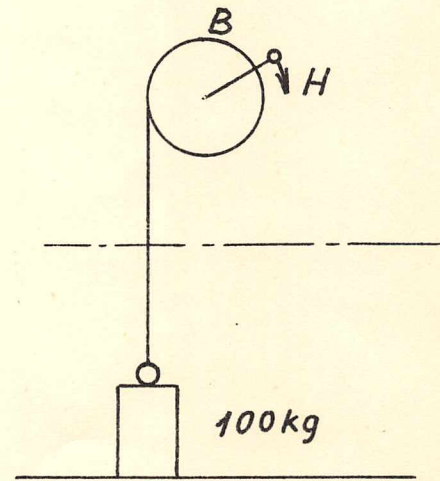

Fig. 24

Magnetisme og elektricitet.



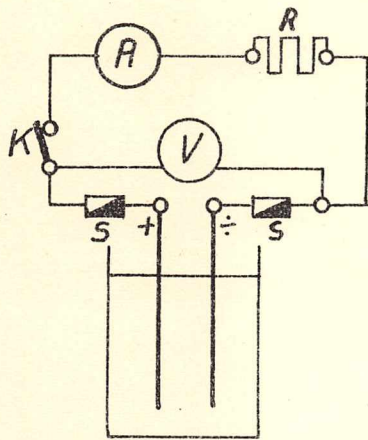
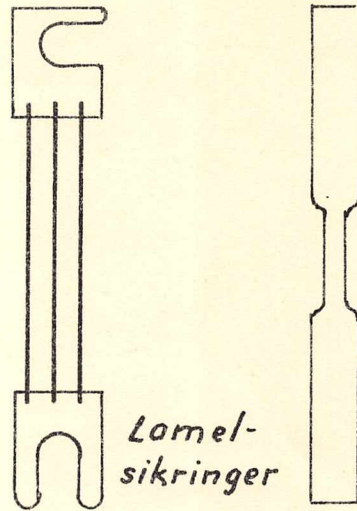

Fig. 25



Lamel-sikringer

Fig. 26

Fig. 27

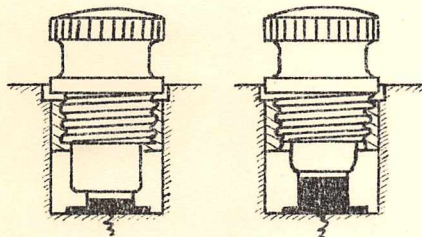

6 Ampere 15 Ampere  
Propsikringer

Fig. 28

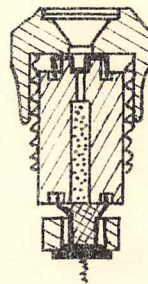

Diazedsikring

Fig 29

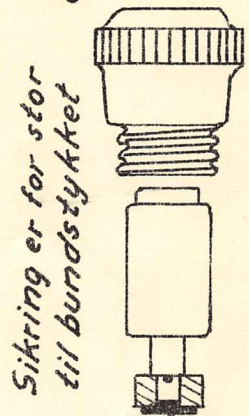

Sikring er for stor  
til bundstykket

Fig. 30

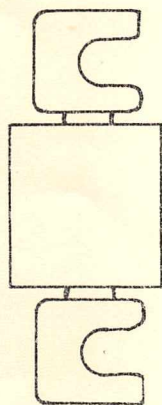

Patronsikring

Fig. 31

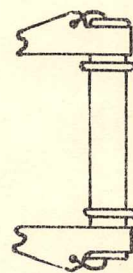

Rørsikring

Fig. 32

Magnetisme og elektricitet.



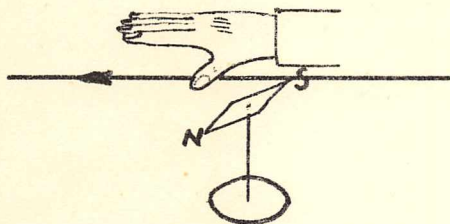

Fig. 33

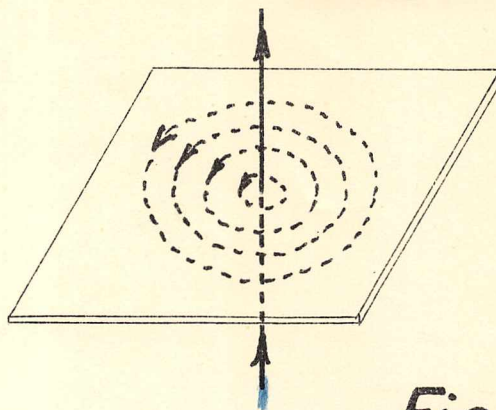

Fig. 34

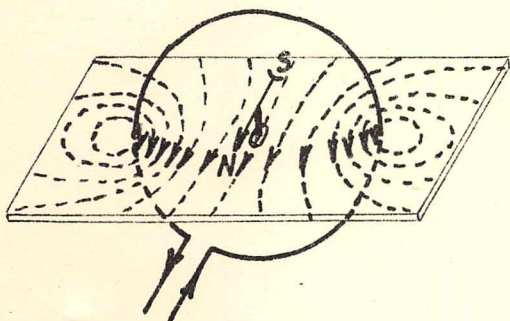

Fig. 35

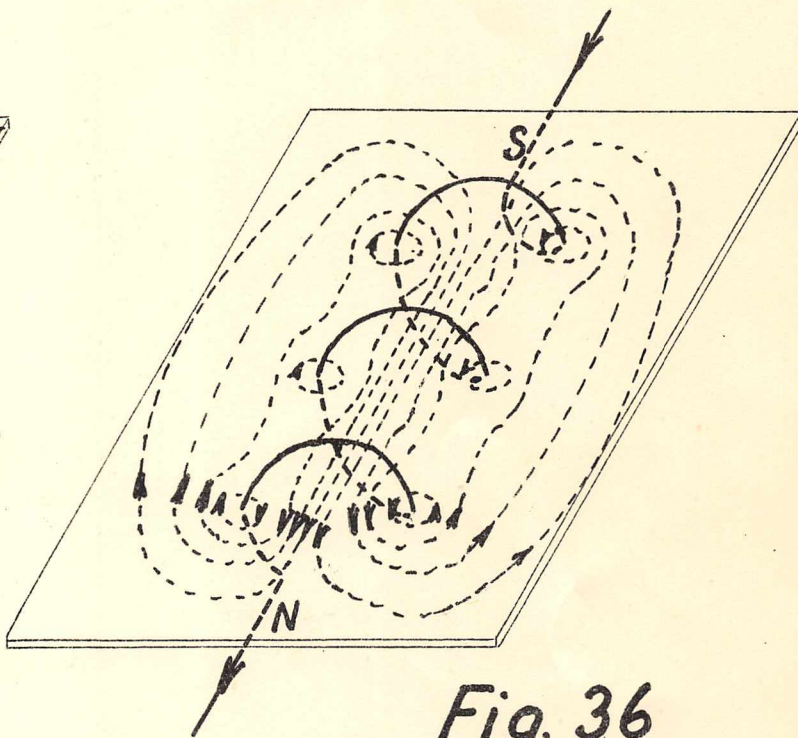

Fig. 36

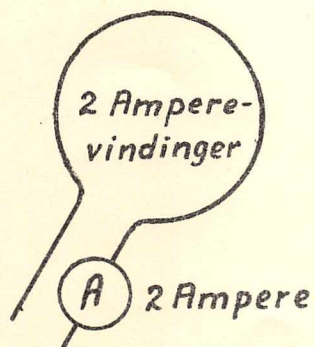

Fig. 37

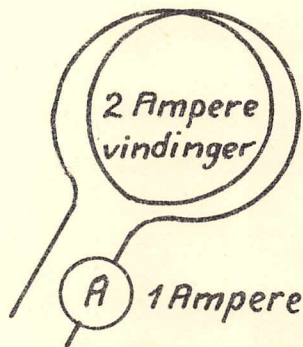

Fig. 38

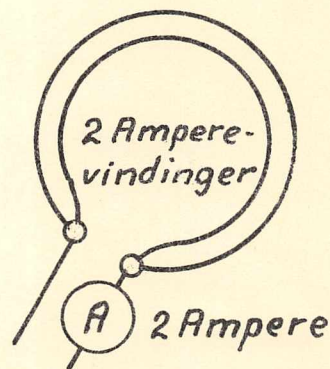

Fig. 39



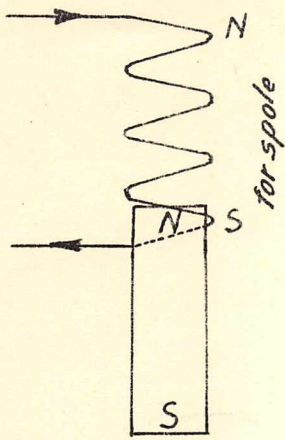

Fig. 40A

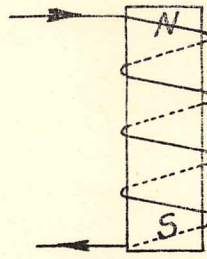

Fig. 40B

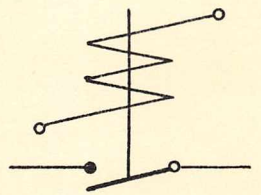

Fig. 41

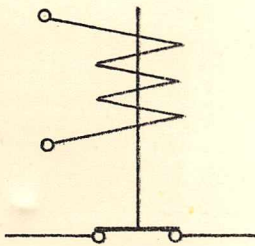

Fig. 42

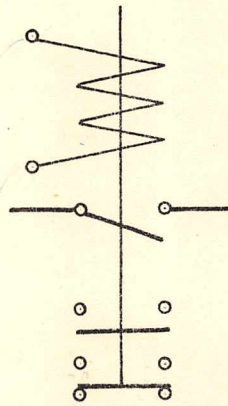

Fig. 43

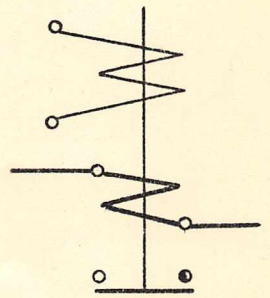

Fig. 44

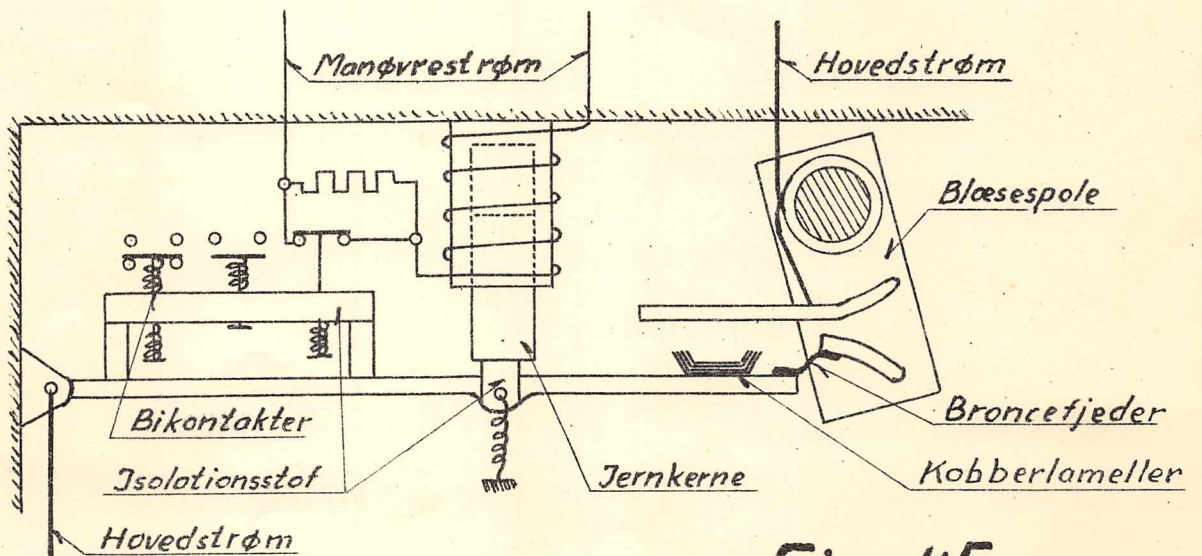

Fig. 45

Magnetisme og elektricitet.



Gnistens bevægelsesretning

V

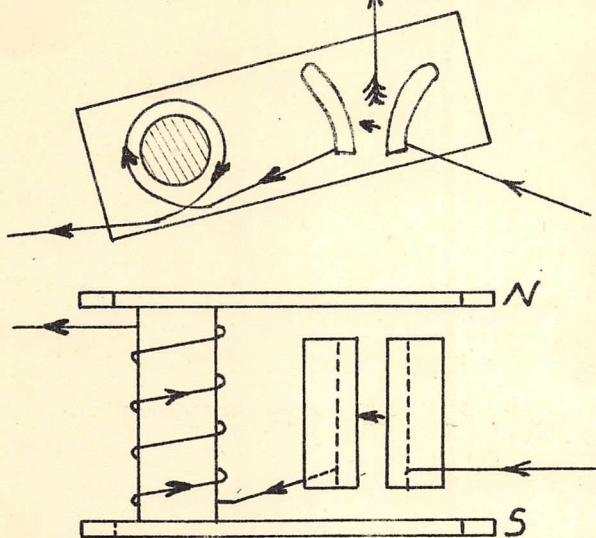

Fig 46

Millivoltmeter

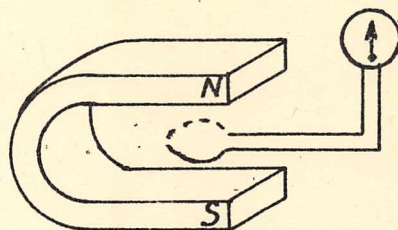

Fig. 47

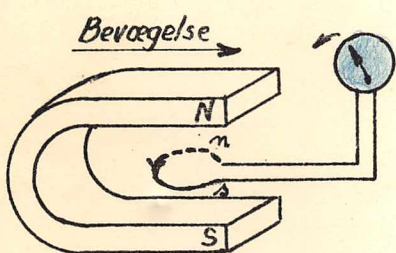

Fig. 48

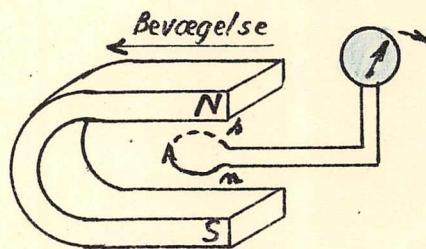

Fig. 49

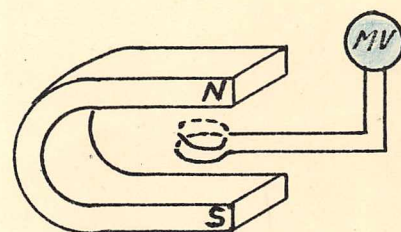

Fig. 50

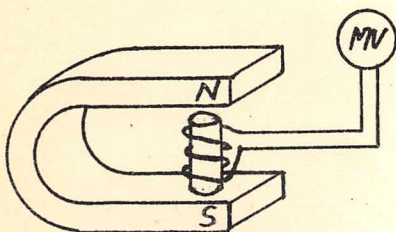

Fig. 51

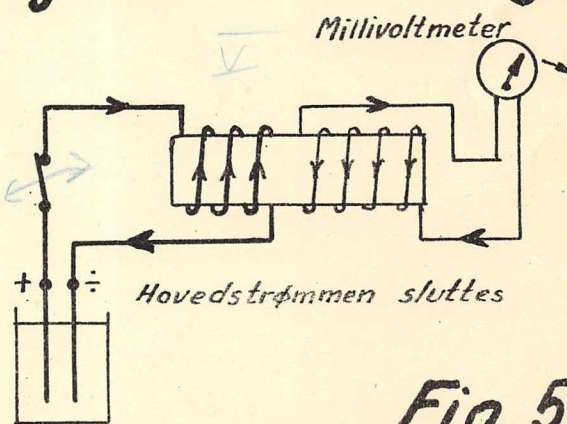

Fig. 52 a

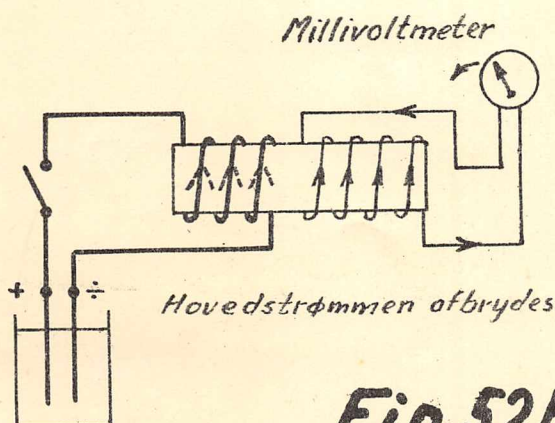

Fig. 52 b

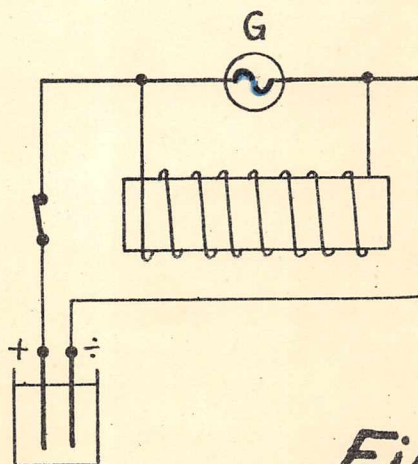

Fig. 52 c

selvinduktion

Magnetisme og elektricitet.



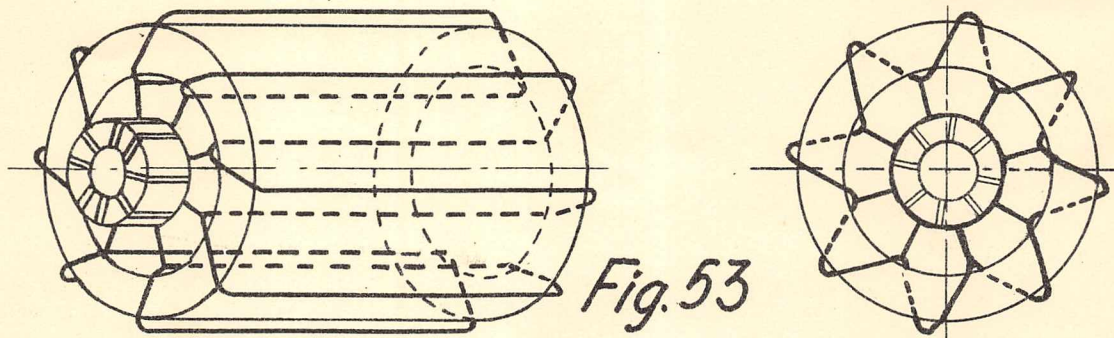

Fig. 53

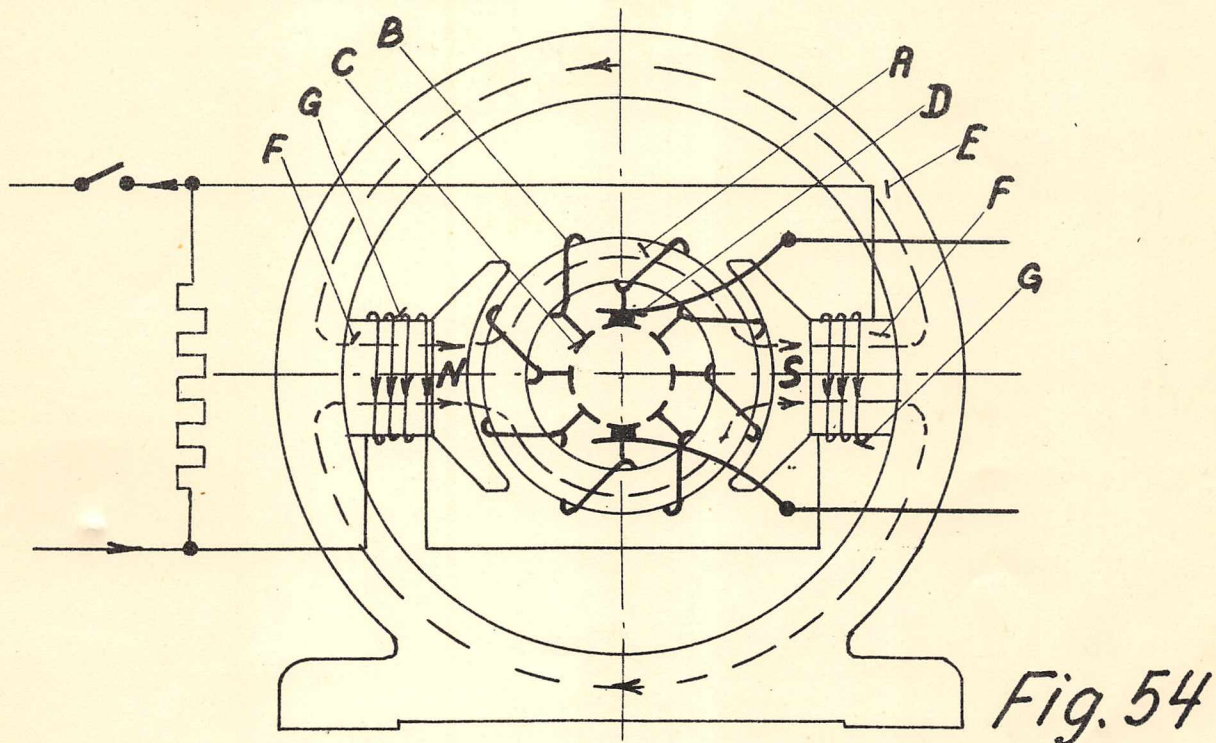
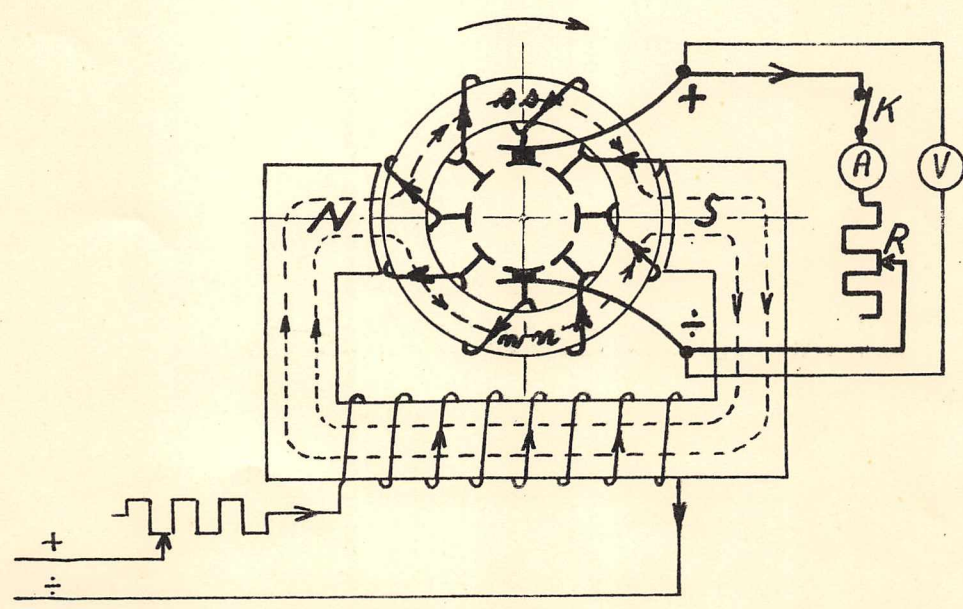

Fig. 54



Fremmedmagnetiseret dynamo.

Fig. 55

Magnetisme og elektricitet.



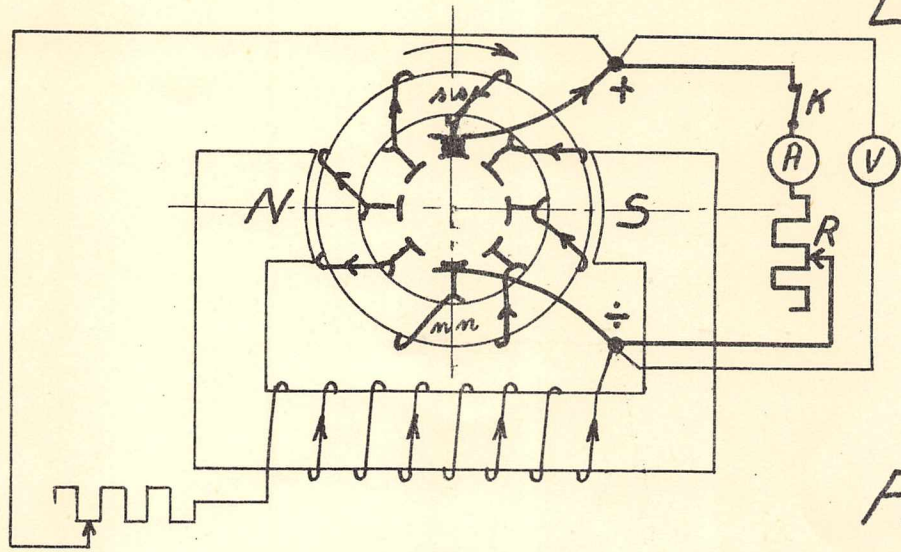

Shunt dynamo.

Fig. 56

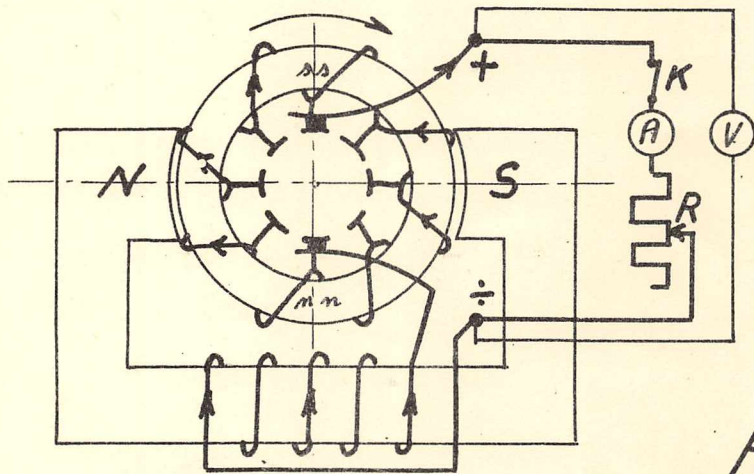

Series dynamo.

Fig. 57

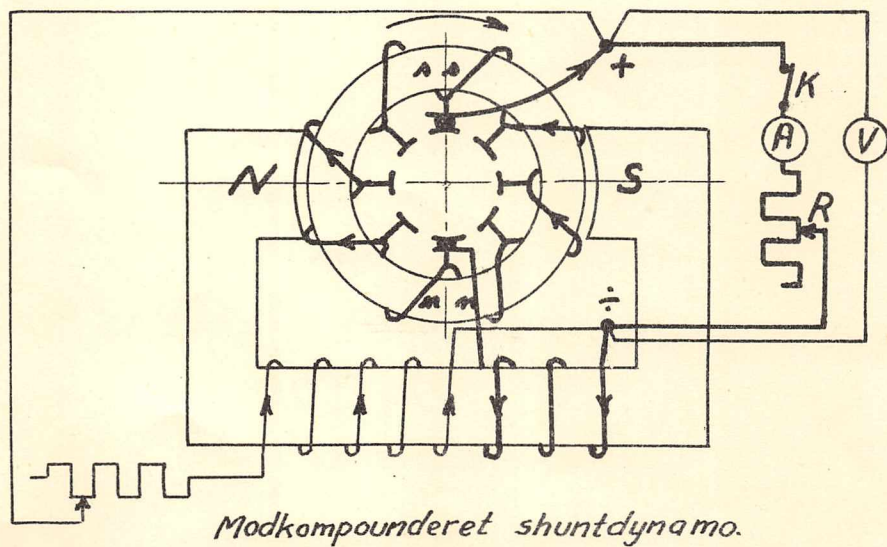

Modkomponderet shunt dynamo.

Fig. 58

Magnetisme og elektricitet.



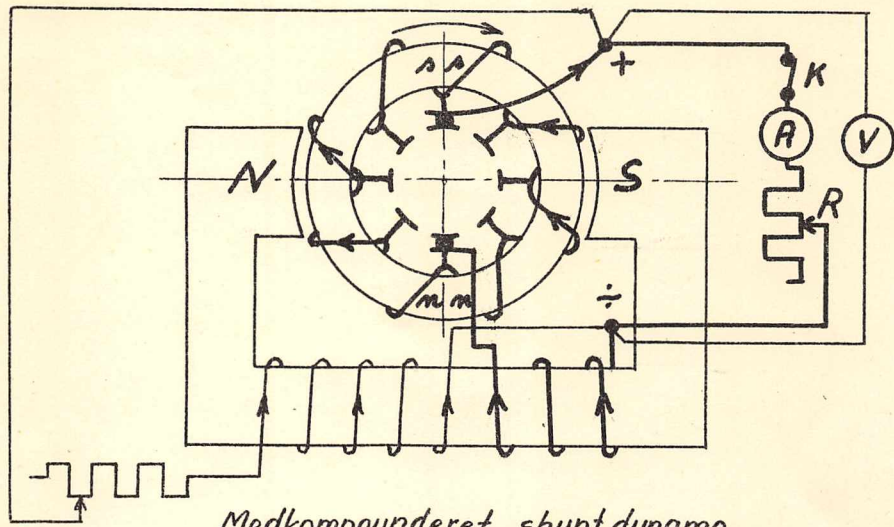

Medkomponderet shunt dynamo.

Fig. 59

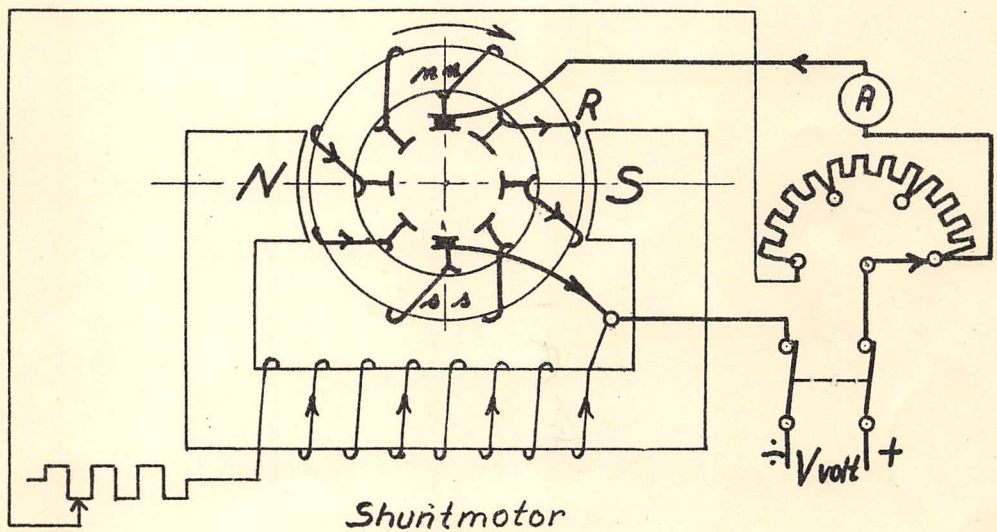

Shuntmotor

Fig. 60

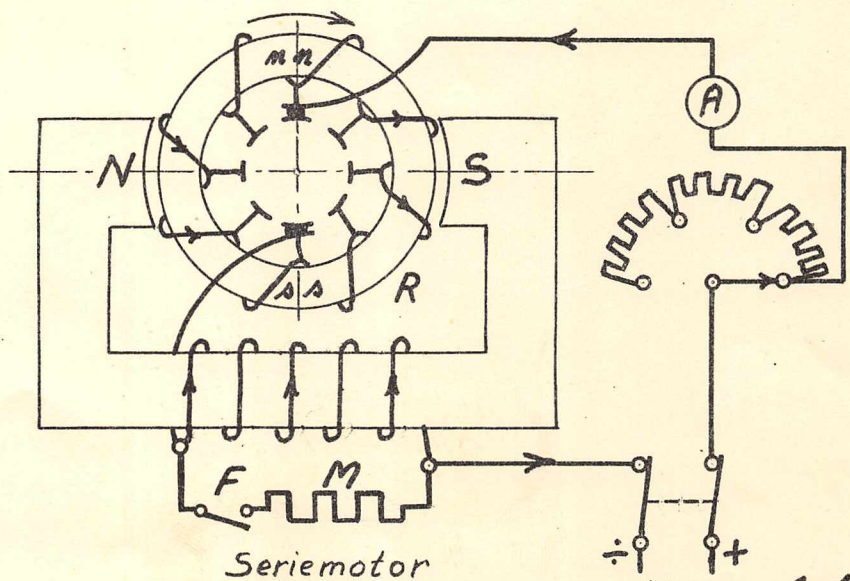

Seriemotor

Fig. 61

Magnetisme og elektricitet.



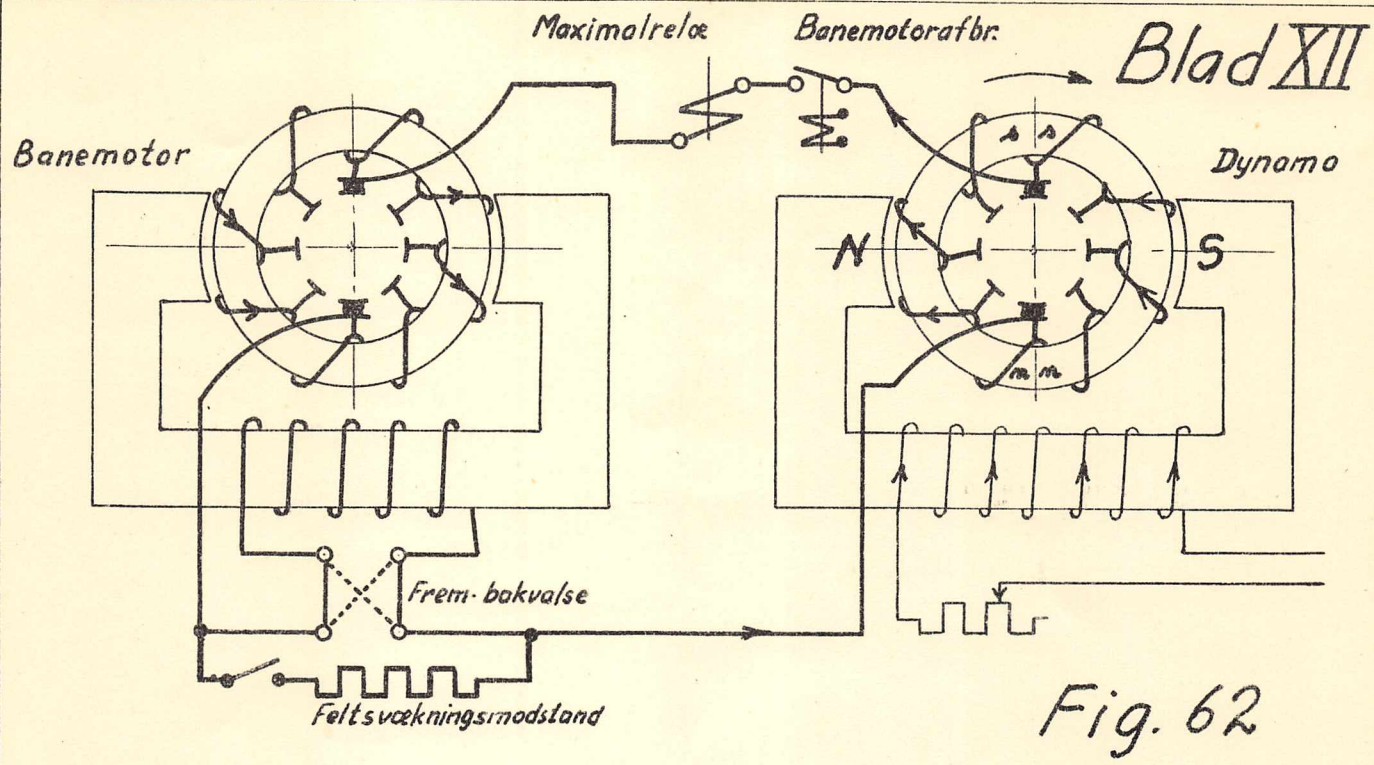

Fig. 62

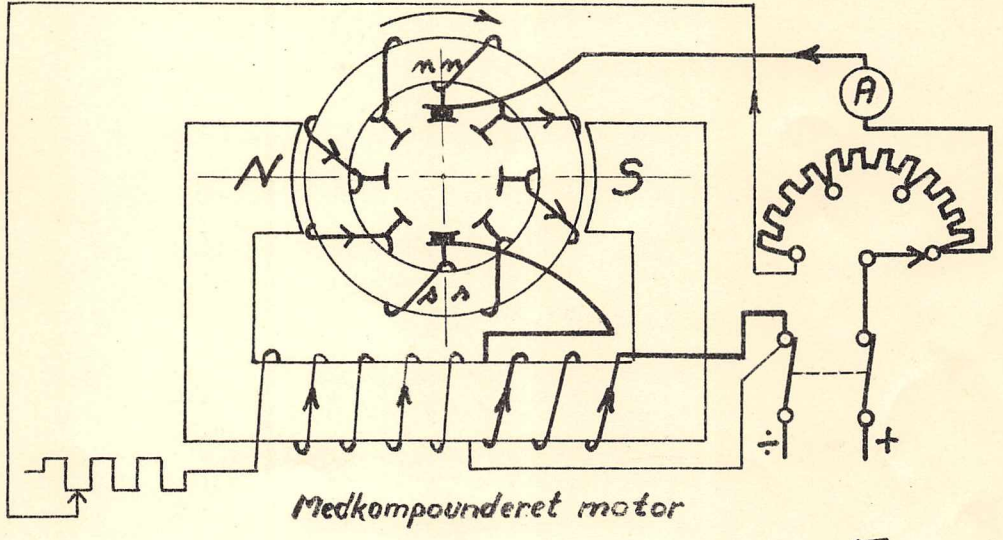

Fig. 63

ML strømskema

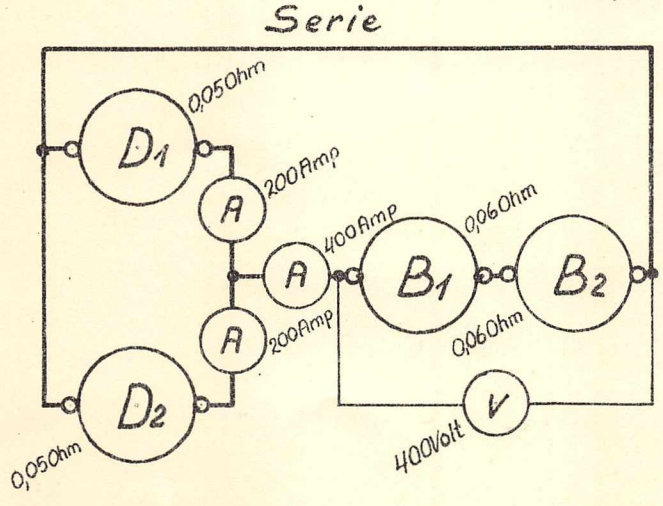

Fig. 64a

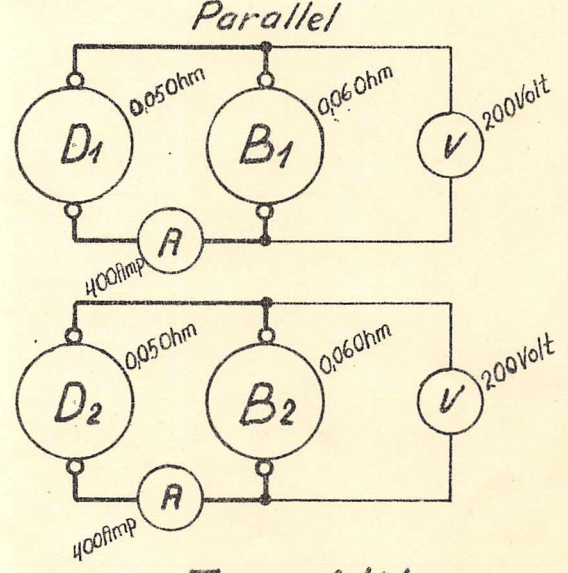
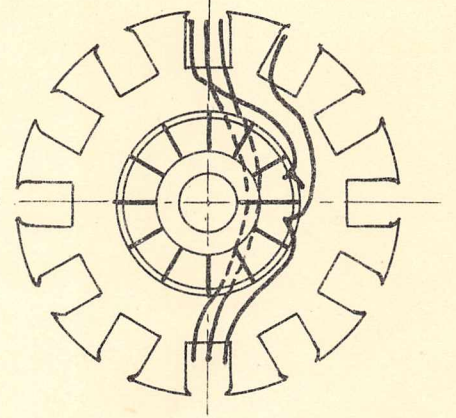
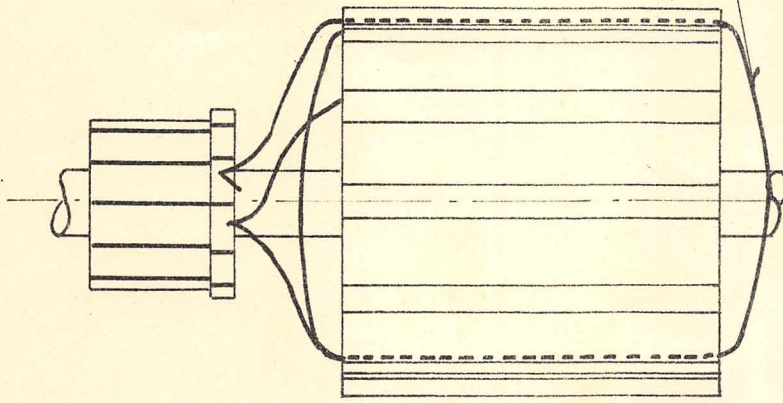

Fig. 64b



Spolehoved



Tromleanker  
Fig. 65

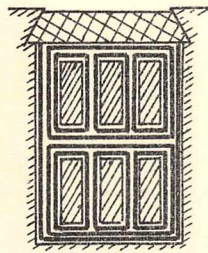

Not med spolesider  
Fig. 66

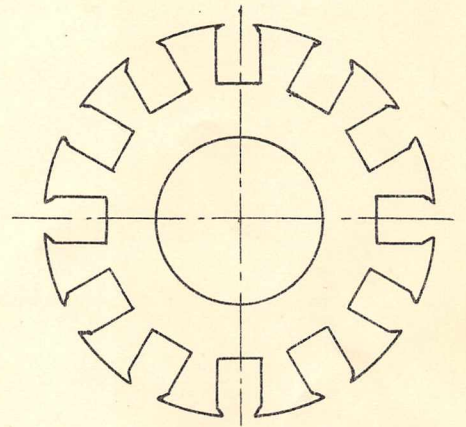

Ankerblikplade med noter  
Fig. 67

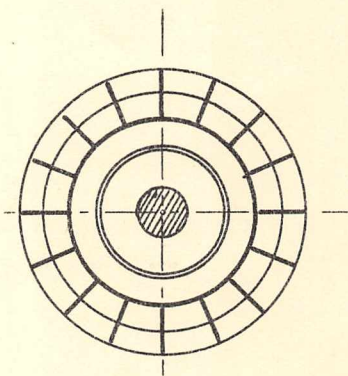
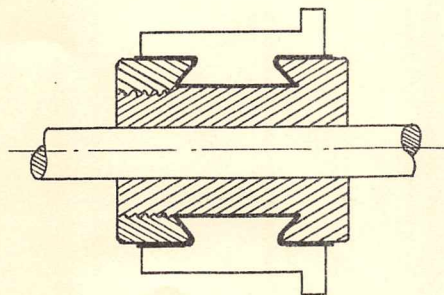

Kommutator

Fig. 68

Magnetisme og elektricitet.



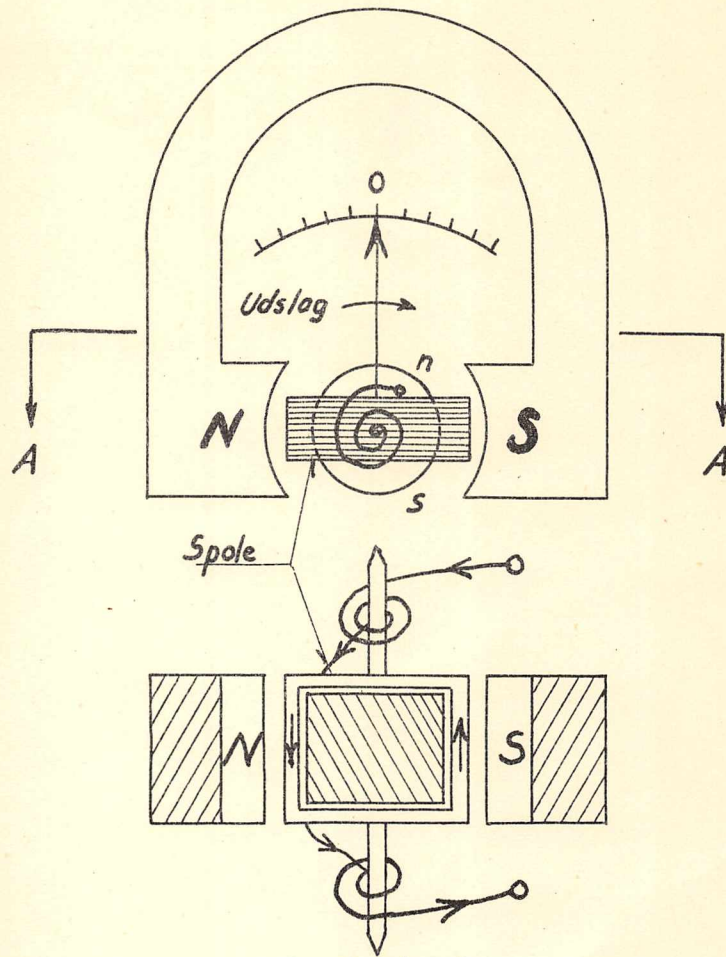

Snit A-A.  
Drejespoleinstrument

Fig. 69

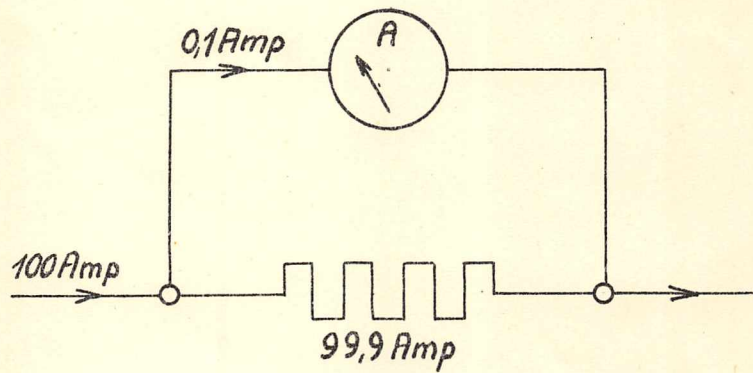

Fig. 70

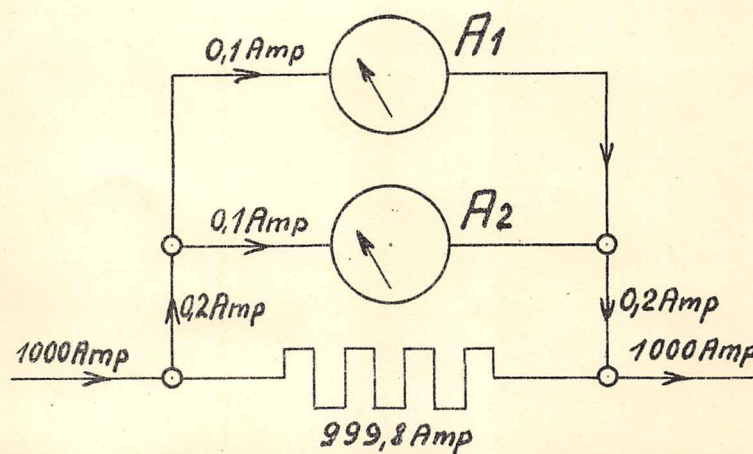

Fig. 71

Magnetisme og elektricitet.



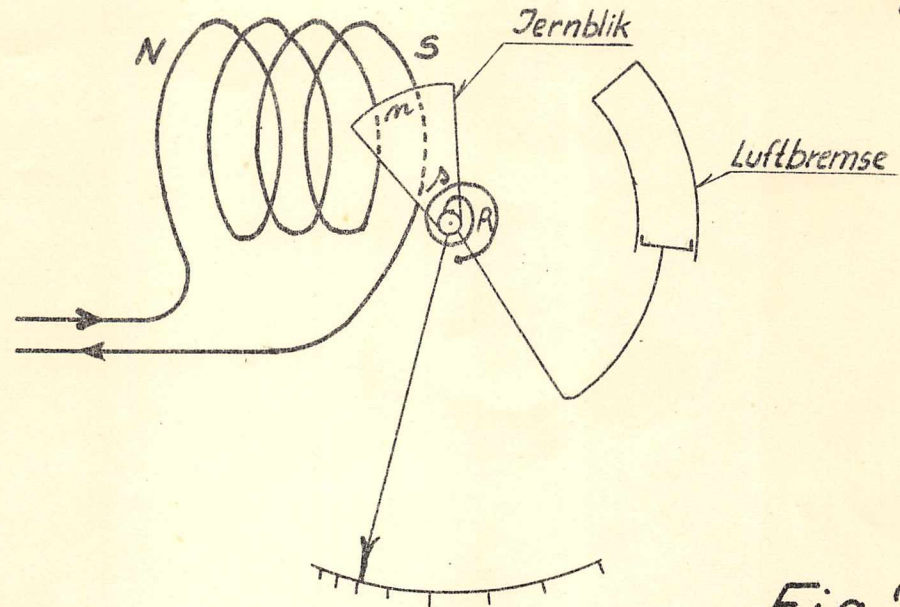

Fig. 72

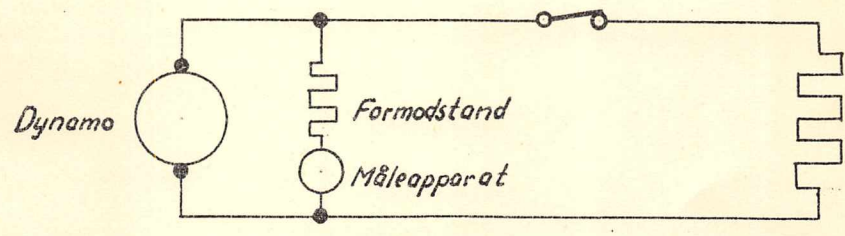

Fig. 73

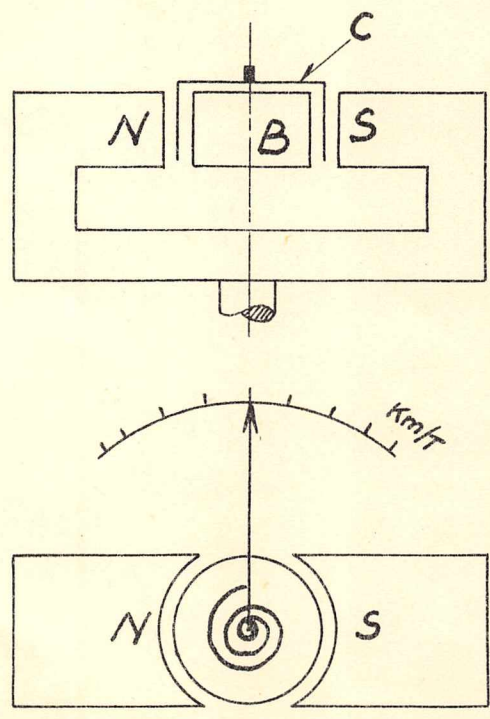

Fig. 74

Magnetisme og elektricitet.



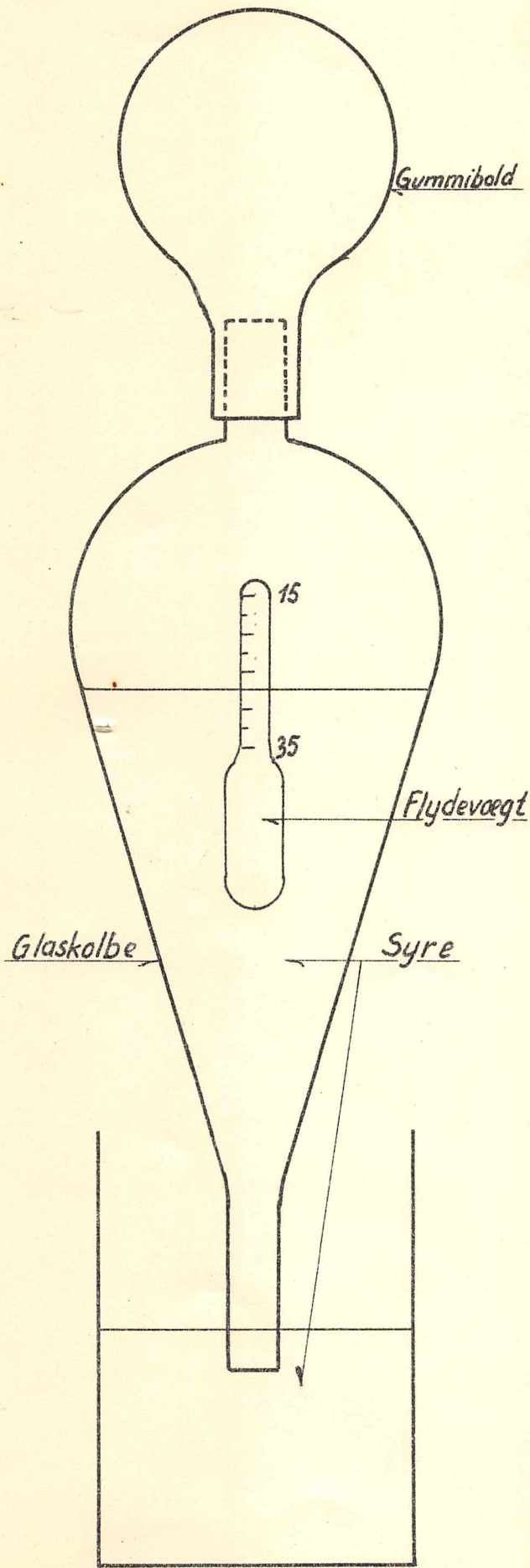
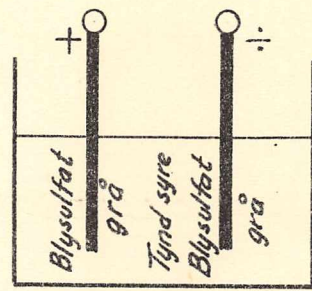
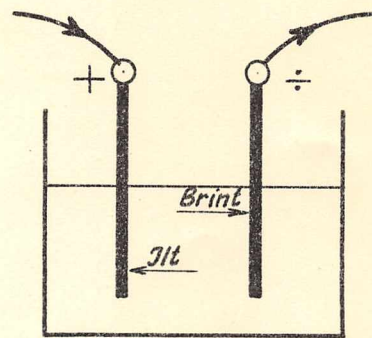

Fig. 75



Afladet celle

Fig. 76a



Celle under opladning

Fig. 76b

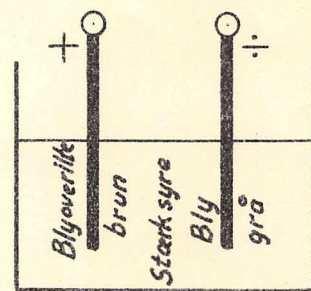

Opladet celle

Fig. 76c

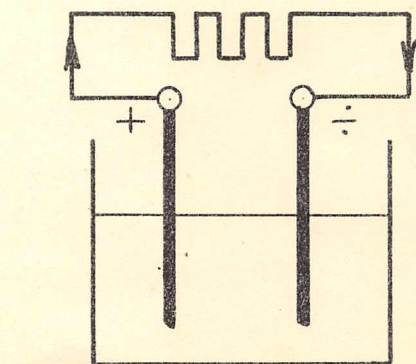

Celle under afladning

Fig. 76d

Magnetisme og elektricitet.



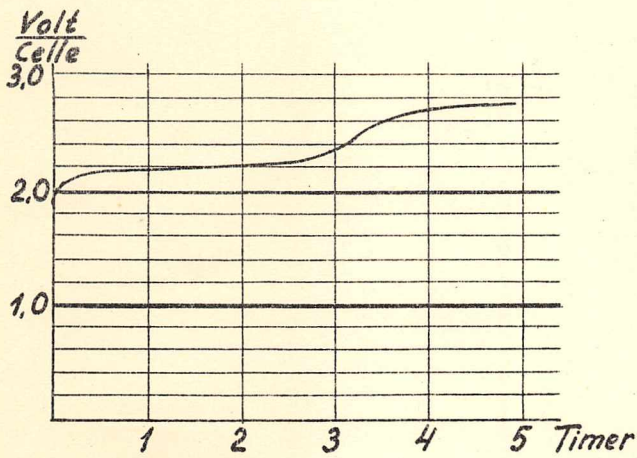

Fig. 77a

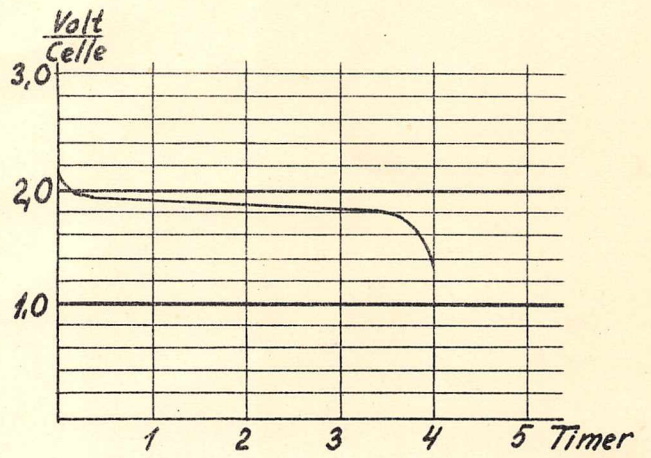

Fig. 77b

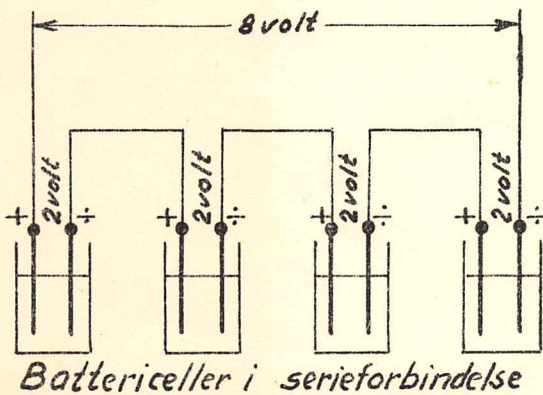

Fig. 78

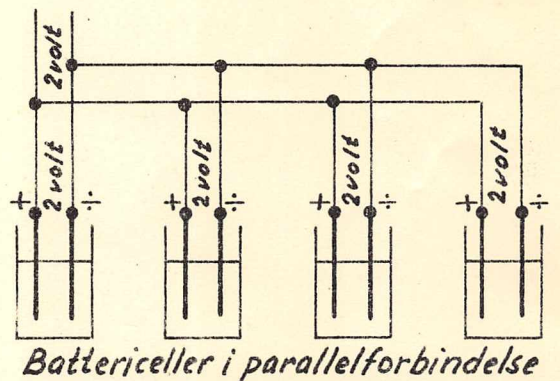

Fig. 79

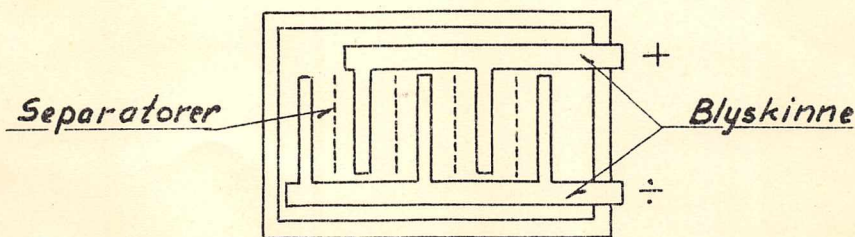

Fig. 80

Magnetisme og elektricitet.



1960

