



**Locomotive  
Feed  
Water**

DSB Museumstog  
Loko-sektionen  
maskindepot Roskilde

LOCOMOTIVE FEED WATER

DSB Museumstog  
Loko-sektionen  
maskindepot Roskilde

## LOCOMOTIVE FEED WATER

Overleaf: An L.M.S. Express picking up  
water at Tebay.

# Locomotive Feed Water

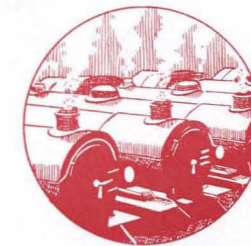

**4, Cromwell Place, South Kensington,  
LONDON, S.W.7.**

Telephone :                      Cables :                      Inland Telegrams :  
Kensington 7231    Alfloc, London    Alfloc, South Kens, London

For ease of administration Alfloc Limited has been merged into its parent company, **I.C.I. (Alkali) Ltd.**, and henceforth will operate as the Alfloc Water Treatment Service of I.C.I. (Alkali) Ltd. It is hoped to provide the same technical facilities as in the past. Therefore, in the text please read for 'Alfloc Limited' as follows :—

**I.C.I. (Alkali) Ltd., Alfloc Water Treatment Service.**

All orders and technical correspondence should be addressed to

**I.C.I. (ALKALI) LTD.  
Alfloc Water Treatment Service  
4, Cromwell Place, South Kensington,  
London, S.W. 7.**

CONTENTS— <i>continued</i>	Page
<b>Choice of water supply and method of treatment</b>	25
<i>The considerations involved in the choice of water supply and the two principal methods of treatment recommended—'External' treatment by the Lime-Soda Process, and the 'Alfloc' System of 'Wayside' Treatment.</i>	
<b>'External' treatment—The Lime-Soda Process</b>	27
<i>The principles involved in the Lime-Soda process of water softening and the salient features of suitable plants.</i>	
<b>Explanation of the coagulating effect of Sodium Aluminate</b>	31
<b>Summary of improvements due to the use of 'Alfloc' Sodium Aluminate in the Lime-Soda Process</b>	35
<b>'Wayside' treatment by the 'Alfloc' System</b>	37
<i>Where 'External' Treatment cannot be applied, the 'Alfloc' System of 'Wayside' Treatment is an efficient alternative. Two distinct methods of 'Wayside' Treatment are available, 'Partial Precipitation' and 'Deferred Reaction'; their main features are discussed.</i>	
(a) 'Wayside' treatment by the 'Partial Precipitation' method	37
(b) 'Wayside' treatment by the 'Deferred Reaction' method	41
Comparison of the two methods	41
<b>Other Problems</b>	41
(a) The problem of corrosion	43
<i>In rare cases where corrosion persists in spite of correct softening, special methods of treatment are available which are discussed.</i>	
The Use of 'Alfloc' No. 58 Formula	43
(b) Priming.	45
<i>A discussion of the causes and prevention of priming with special reference to the use of continuous blowdown systems.</i>	
Soluble Salts and Their Relation to Priming	47
Blowdown	47
A Net Economy in Fuel due to Correct Blowdown	49
Heat Recovery	49
<b>Treatment of Highly Saline Waters</b>	51

CONTENTS— <i>continued</i>	Page
<b>Recommendations</b>	51
<i>Main points to be observed in the successful operation of the methods of treatment advocated.</i>	
<b>Selection of methods of water treatment on a railway system</b>	53
<i>A summary of the information required when considering a programme of Railway Feed-water Treatment.</i>	
<b>The supervision of water treatment on a railway</b>	57
<i>The tests and type of supervision required in the operation and control of a water treatment scheme.</i>	
<b>BIBLIOGRAPHY</b>	58
<i>Literature dealing with water treatment, issued by Alfloc Ltd. and Imperial Chemical Industries Ltd.</i>	
<b>APPENDIX</b>	59
<b>A description of the various chemicals mentioned in this booklet</b>	59
Sodium Carbonate	59
Caustic Soda	59
Lime	59
'Alfloc' dry powdered Sodium Aluminate	60
'Alfloc' No. 4-R Liquor	60
'Alfloc' No. 3-R Liquor	61
'Alfloc' Briquettes	61
'Alfloc' No. 42-ABB Briquettes	62
'Alfloc' No. 11 Briquettes	62
Calgon	62
'Alfloc' No. 28 Powder	62
'Alfloc' No. 58 Formula (Briquettes and Powder)	63
'Alfloc' Antifoam	63
<b>Apparatus required for 'Wayside' methods of treatment</b>	63
<i>A short survey of the apparatus required for feeding liquid and solid chemicals in the 'Alfloc' system of 'Wayside' Treatment by the 'Partial Precipitation' and 'Deferred Reaction' methods.</i>	
<b>Choice of suitable apparatus</b>	64
<b>Apparatus for feeding solutions and solids</b>	64
(a) <i>Apparatus for Liquid Feed</i>	64

CONTENTS — <i>continued</i>	<i>Page</i>
<b>The 'Nalco' Chemical Proportioner</b>	65
Various Types of 'Nalco' Proportioners	66
(a) and (b) AS 'Nalco' Chemical Proportioner	66
(c) AM 'Nalco' Chemical Proportioner	69
(d) ADM 'Nalco' Chemical Proportioner	75
(e) AR 'Nalco' Chemical Proportioner	76
(f) AW 'Nalco' Chemical Proportioner	77
(g) AGB 'Nalco' Chemical Proportioner	78
<b>'Nalco' Water Motors</b>	80
<b>Chemical Storage Tanks</b>	84
<b>Installation and Operating Costs</b>	84
<b><i>(b) Apparatus for Feeding Solids</i></b>	84
'Alfloc' By-pass Feeders	84
How to Operate 'Alfloc' By-pass Feeders	85
Types of 'Alfloc' By-pass Feeders	86
Installation of By-pass Feeders	87
'Partial Precipitation' Method	89
'Deferred Reaction' Method	90
Cost of Installation and Operating By-pass Feeders	91
<b>INDEX</b>	92
<b>ENQUIRIES</b>	101

## FOREWORD

Water consumption on any Railway is a considerable item of running expenditure. The cost of the water, however, may be far less than the cost of the damage caused by the impurities it contains. The first charge is inevitable, but expenditure on repairs and renewals, caused directly and indirectly by these impurities, can be greatly reduced by correct methods of water treatment. Such methods involve the expenditure of only a fraction of the cost of boiler maintenance and repairs. They permit savings to be effected in other directions, such as decreased fuel consumption and increased running life of the locomotive. These facts have been proved by the practical operating experience of Railway Companies in all parts of the world.

---

*Alfloc Ltd. wish to thank the following British Railway Companies for their co-operation in the production and supply of many of the illustrations in this publication: The Great Western Railway Co. Limited, The London Midland & Scottish Railway Co. Limited, The London & North Eastern Railway Co. Limited, The Southern Railway Co. Limited*

## INTRODUCTION

THE softening and conditioning of water for use in stationary boilers has for long been standard practice, but only comparatively recently have the specialized problems of water treatment as applied to railway systems been successfully solved.

Experience has shown that the fullest economies and benefits obtainable from feed-water treatment are only realised when it is applied to a railway system as a whole, and not merely at those points where boiler maintenance costs are high. The aim of the treatment should be to keep the composition of the water in all the locomotive boilers on a railway system at a standard equal to that accepted in stationary boiler practice.

### THE 'ALFLOC' SYSTEM AND SERVICE

This booklet has been written to bring before railway companies the salient features of a scheme for such treatment developed by Alfloc Ltd., an associated company of Imperial Chemical Industries Ltd., and of the National Aluminate Corporation of America, who were pioneers in this field of water treatment.

Alfloc Ltd. are primarily interested in the development of chemical processes of water treatment, and in the supply, through their associated companies, of the chemicals necessary for such treatment. They have therefore made a special study of railway feed-water problems, and as a result they are in a position to offer free technical service facilities as follows:

1. General consultation and submission of schemes for water treatment.
2. Assistance in the starting-up and operation of water treatment plants.
3. Information on the economic and chemical aspects of feed-water treatment and the control of water softening and conditioning.
4. Research facilities in the 'Alfloc' laboratory at Bush House, and in the research departments of their associated companies, for the investigation of any particular problem of water softening and conditioning.

'Alfloc' products are either standard chemicals or mixtures of such chemicals. The trade name provides a guarantee of their high quality and composition, and in no way indicates products of a secret or proprietary character.



## The Need for Water Treatment

The object of water treatment on railways is to make the operation of the locomotives more efficient and economical. Correct water treatment enables pitting and corrosion of boiler tubes to be overcome, the heating surfaces of the firebox and firetubes to be kept free from scale, and the locomotive to remain in service without 'washouts' or changes of water for extended periods. Running repairs and periodical overhauls take place during the life of any locomotive boiler, but it is often not fully appreciated how rapidly the action of scale formation and corrosion is reflected in maintenance cost and in reduced life of tubes, stays and fireboxes.

Scale formation, apart from causing increased fuel consumption, retards heat transference, thus causing 'bulging', 'leaking', and similar troubles. This leads inevitably to the withdrawal of the engine from service for caulking of the leaks and replacement of the tubes or other damaged parts. Where corrosion occurs it may cause isolated pitting or the dangerous condition known as 'grooving' or 'necking', leading to perforation of the evaporative surfaces. Premature failure of important parts of the locomotive boiler may result, and once damage has occurred there is no alternative but to withdraw the locomotive from service and carry out the necessary repairs.

It has been found that the life of a boiler tube varies according to the composition of the water evaporated, which in turn varies widely according to the sources of supply. With bad waters, boiler tubes may only last a few months, whereas with better types of natural water their life may be considerably longer.

The principal savings which can be effected by correct treatment of locomotive feed water are as follows:

1. Reduction in repairs and boiler maintenance, including labour costs.
2. Increased life of tubes and fireboxes.
3. Saving in 'engine time' due to extension of periods between repairs.
4. Saving in 'engine time' due to extension of periods between washing out the boiler.
5. Decreased fuel consumption.

Care taken in the selection and treatment of water for use in locomotives will therefore be amply repaid. Methods of treating existing supplies are dealt with in this booklet, but where alternative sources of supply are available, Alfloc Limited will advise on their relative suitability for locomotive feed and other purposes.

## Assessment of Damage Caused by Scale

Before considering the installation of any scheme of water treatment, railway engineers will, no doubt, take steps to ascertain the potential economies which may be obtained. It is difficult to assess the damage done to a locomotive boiler by the water which it uses, since most locomotives evaporate waters of varying composition. This explains why, in the past,





so little has been known about the economies which can be obtained by correct water treatment on railways.

Two formulæ in particular for assessing such economies have been developed which can be of great assistance to railway engineers.

The first formula, which is perhaps the more widely known, was devised by the American Railway Engineering Association, who demonstrated by means of practical trials that 'the amount of damage done by every pound of untreated scale-forming matter entering a boiler was equivalent in cost to thirteen cents' (i.e. about 6d. per pound of scale-forming matter).

An English railway company has also devised a formula which they have used in drawing up their own water treatment programme. This formula takes into account the difference in the effects of the temporary and permanent hardness constituents of the water, and was obtained by comparing the life and shop maintenance costs of boilers in three large areas which have different types of waters, having soft, medium hard, and very hard waters respectively.

It was found that each ton (2,240 lb.) of permanent hardness entering the boiler caused damage equivalent to £85 sterling, and that each ton of temporary hardness caused damage to the extent of £15 sterling. This formula indicates the savings possible in the boiler repair shops, but takes no account of possible additional savings in the running sheds.

With the average type of waters encountered, using this formula, the results correspond closely with those obtained using the American Railway Engineering Association formula.

Both the American and English methods of computing the savings possible, by correct water treatment, have been shown to give a close approximation to those which have actually been obtained in practice. That considerable savings can be obtained is proved by the following examples:

A large running shed in England is making a steady net saving of several thousand pounds per annum by proper methods of water treatment. The maintenance staff has been considerably reduced; there are now only one or two cases of leakage and corrosion reported annually, and the engines operating from this depot are in use for greatly extended periods.

A certain railway company, after allowing for every possible cost, reports a net saving of about £170,000 per annum, due to decreased fuel consumption, and reduction in maintenance and repair bills.

Another company, before commencing treatment of their water supplies, had a total of 186 'failures' in one year directly traceable to untreated water. After the adoption of scientific methods of treatment the number of failures was progressively reduced until, five years later, when their full water treatment scheme was in continuous operation, the number of failures was only two. They have also reported a net annual saving of £116,000 in fuel consumption and repairs cost.

An Indian railway reports an annual saving of Rs.103,230 by correct treatment, even though their total requirements were only 7,000 gallons of feed-water per day.



Temporary and permanent hardness are two causes of scale formation. They may also be responsible for corrosion. The photograph shows tubes from a Locomotive running on untreated water of medium hardness. Note thickness of scale and commencement of 'pitting'. *London & North Eastern Railway Co., Ltd.*

The foregoing examples are representative of many reports submitted by railway companies in various parts of the world, and show what can be done by the adoption of scientific methods of water treatment.

To obtain these savings, it is necessary to adjust the composition of the water in the boilers to a point where scaling corrosion and priming are avoided, and to maintain these conditions during the working life of the locomotive. On stationary boilers this has long been customary practice and is not difficult to attain, as the feed-water is usually of fairly constant composition and can be successfully treated by the methods of conditioning described in this book.

As regards railway boilers, satisfactory treatment in the past has been more difficult to achieve owing to the many types of water used by the locomotives, and the widely varying amounts 'picked up'. Many railways, therefore, only treated those supplies where a large quantity was used, or where the water gave rise to excessive troubles. Now that the 'Alfloc' system of 'wayside' treatment is available, railway engineers are carrying their schemes of water treatment to completion, and in this connection the following statement by the chief engineer of one of the most important British railways should be noted:

'We shall not be content until every drop of water used by our locomotive boilers—no matter how small the supply—receives adequate chemical treatment.'

## Impurities in Natural Water

The impurities in all natural water supplies are directly responsible for the various operating difficulties already mentioned. The principal impurities are of three main types:

- (a) Dissolved gases.
- (b) Organic matter.
- (c) Mineral salts.

### (a) Dissolved Gases

These gases are mainly oxygen and carbon dioxide; they are a frequent cause of pitting and corrosion, and can be dealt with by methods described on page 21.

### (b) Organic Matter

These impurities may be present either in solution or as suspended matter. For use in locomotive boilers the suspended matter should be removed, where possible, by sedimentation or filtration, assisted by coagulation. Organic material is generally derived from the decomposition of vegetable matter; it occurs principally in water supplies from moorland and forest districts, and may render the water acid. Unless treated by methods described later such waters give rise to pitting and corrosion, and one authority claims that organic matter is an important factor in causing 'priming'.



General corrosion of Locomotive boiler tubes. Isolated 'pitting' is also apparent. *London Midland & Scottish Railway Co., Ltd.*

### *(c) Mineral Salts*

Mineral salts present in solution may be responsible for the production of scale, and in many cases they are also the cause of pitting and corrosion.

The principal salts occurring in natural waters are compounds of calcium, magnesium and sodium; these usually occur in the form of bicarbonates, sulphates, chlorides and nitrates. Traces of iron and aluminium salts are also found.

Another mineral constituent of considerable importance is silica, which exists both in combination and in colloidal suspension.

The quantities of these impurities which natural waters contain vary considerably, and when the chemistry of water treatment was originally under investigation, the need for a basis of comparison was realized. It was known that certain waters felt hard or soft to the touch and varied in the amount of soap they required to produce a lather. This latter property was directly traced to the presence of calcium and magnesium salts, and it was found that the quantity of soap required to form a permanent lather was directly proportional to the quantity of these salts present in any water. Moreover, it was found that waters which felt soft to the touch contained only small quantities of these salts and required only small amounts of soap to give a lather, while waters which felt hard contained relatively large quantities of calcium and magnesium salts and needed large amounts of soap before lathering. Hence the terms 'hard' and 'soft' water were derived and units of 'hardness' were defined.

In England the commonly accepted unit is the 'degree of hardness', which is defined as being equivalent to the hardness produced by one grain of calcium carbonate (chalk) per Imperial gallon (i.e. one part of calcium carbonate to 70,000 parts of water). The unit of hardness in the metric system is defined as being equivalent to the hardness produced by one part of calcium carbonate per 100,000 parts of water. To avoid confusion the English term 'degrees of hardness' should only be used in the sense of 'grains of  $\text{CaCO}_3$  per Imperial gallon'. In other cases the units should be defined.

Temporary hardness is mainly responsible for the formation of soft scales and sludge; permanent hardness and silica are principally responsible for the formation of hard scale. Methods for the removal of hardness are described later in this section.

Many waters contain, in addition to the salts already mentioned, small quantities of the sulphate, chloride and possibly nitrate of sodium. In small amounts these salts are harmless, but highly saline waters, however, may give rise to 'priming' (see page 51).

In certain waters, principally derived from deep wells, sodium bicarbonate is present, and may cause corrosion; in the case of boiler feed-water it should be remembered that sodium bicarbonate is a soluble salt, and, furthermore, decomposes in the boiler to produce sodium carbonate, caustic soda (which may cause embrittlement) and carbon dioxide (which may cause corrosion). Caustic embrittlement is the name given to the intercrystalline cracking of stressed steel in the presence of high concentrations of caustic soda. This phenomenon is rare in railway practice, and methods for preventing this type of failure are well known and easily applied.

## Methods of Removal of the Impurities in Natural Water Supplies

### (1) Dissolved Gases

#### OXYGEN

Since it is difficult to adapt any process of mechanical de-aeration to locomotive feed-water before it is taken up by the locomotive, the process of oxygen removal must be applied on the locomotive. Some railways use a system of de-aeration in connection with feed-water heaters, whilst others are concentrating on the 'top feed' system. In this system the water, on entering the boiler, flows into a trough, where the gases are liberated by the action of the heat, thereby lowering the quantity of gas present in the main bulk of the boiler water, with consequent reduction of corrosion on the main heating surfaces.

Certain chemicals can also be used to absorb the oxygen, and amongst them are various tannins; it has been found that by blending selected tannins and combining them with certain phosphates a product is obtained which exerts a marked inhibiting effect on corrosion due to oxygen. (See page 43, 'Alfloc' No. 58 Formula.)

#### CARBON DIOXIDE

This gas is removed from solution by heat in the same way as oxygen, or by the hydrated lime used in the lime-soda process of water softening (see page 27). It is also absorbed by caustic soda, which may be used in the 'Alfloc' process of 'wayside' treatment (see page 37).

### (2) Organic Matter

The amount of organic matter in solution can often be considerably reduced by coagulation in the lime-soda process of water softening (see page 33); where the water is very soft and will not require treatment by the lime-soda process the organic matter can be coagulated by the use of sodium aluminate and aluminium sulphate, followed by filtration (preceded by sedimentation where necessary). Where, however, the quantity of water used is small, the acidity usually associated with the organic matter in this type of water will be neutralized by means of the alkalis present in the chemicals used in the 'Alfloc' method of 'wayside' treatment (see page 37).

### (3) The Removal of Mineral Impurities

#### TEMPORARY HARDNESS

This consists of the bicarbonates of calcium and magnesium. As already explained, temporary hardness is always decomposed into the corresponding carbonates when the water is boiled. The calcium carbonate, being practically insoluble, is thrown down as a precipitate. Although at atmospheric pressure a large proportion of the magnesium carbonate would remain in



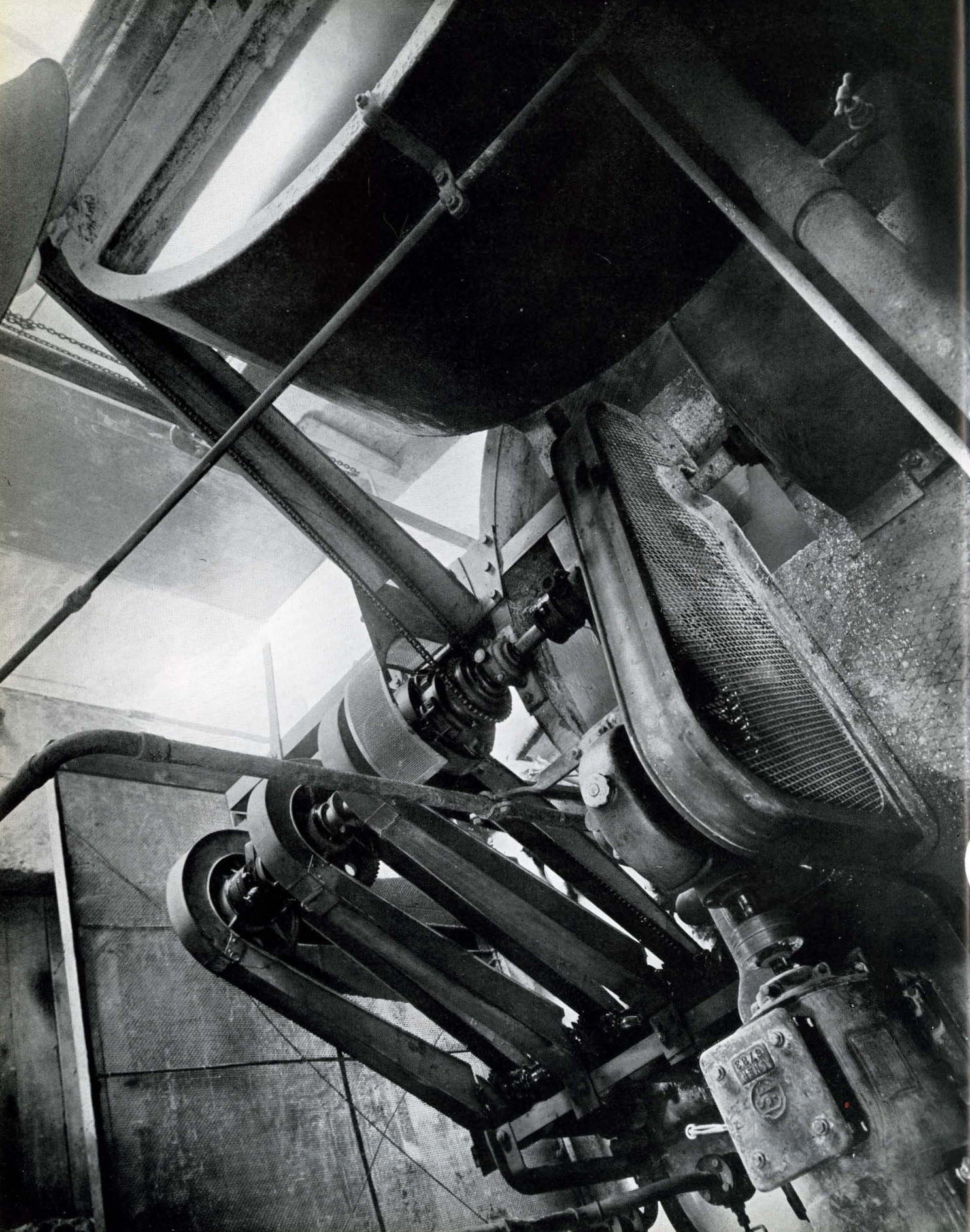

solution, at higher pressures (e.g. in locomotive boilers) the magnesium carbonate decomposes and the magnesium is precipitated as magnesium hydroxide.

In the 'Alfloc' system of 'wayside' treatment the temporary hardness is removed by this action of heat inside the boiler.

It is obviously uneconomic, however, to remove the temporary hardness from large quantities of water by boiling before it enters the boiler. In such cases the hydrated lime used in the lime-soda process of water softening (see page 27) is employed to remove the temporary hardness from the boiler feed. In this process the two principal chemicals used are calcium hydroxide (hydrated lime) and sodium carbonate (soda ash)—the latter being used to remove the permanent hardness (*q.v.*).

The hydrated lime decomposes the calcium bicarbonate, forming the practically insoluble calcium carbonate and leaving nothing in solution. It also decomposes the magnesium bicarbonate, eventually forming magnesium hydroxide, which is relatively insoluble. This last reaction is comparatively slow, and colloidal magnesium hydroxide is frequently produced, which remains in solution, thereby increasing the residual hardness and caustic alkalinity in addition to rendering the water unstable and liable to 'after precipitation'. Magnesium hydroxide can, however, be removed by the use of the coagulant, 'Alfloc' sodium aluminate. (See page 31, and also the booklet, 'Alfloc Sodium Aluminate in the Lime Soda Process'.)

## PERMANENT HARDNESS

### *Calcium Salts*

The permanent hardness due to calcium salts may be removed by converting them to the corresponding soluble sodium salts by the use of sodium carbonate, which precipitates the calcium as insoluble calcium carbonate. This result can be achieved in several ways:

1. The sodium carbonate may be added direct to the water, as in the lime-soda process (see page 27). In this case the calcium carbonate is precipitated before the water enters the boiler.
2. The sodium carbonate may be added direct to the water as in certain forms of the 'Alfloc' methods of 'wayside' treatment; the calcium carbonate may thereby be partly precipitated before the water enters the boiler, the remainder being completely precipitated in the boiler as harmless sludge.
3. Sodium carbonate may be formed by the interaction of the bicarbonates of the temporary hardness and the caustic soda which is present when some forms of the 'Alfloc' 'wayside' treatment process are employed (*q.v.*). In this case the results are the same as in paragraph 2 above.

### *Magnesium Salts*

From those magnesium salts which contribute to the permanent hardness, magnesium is removed as the insoluble hydroxide. This may be achieved in several ways:

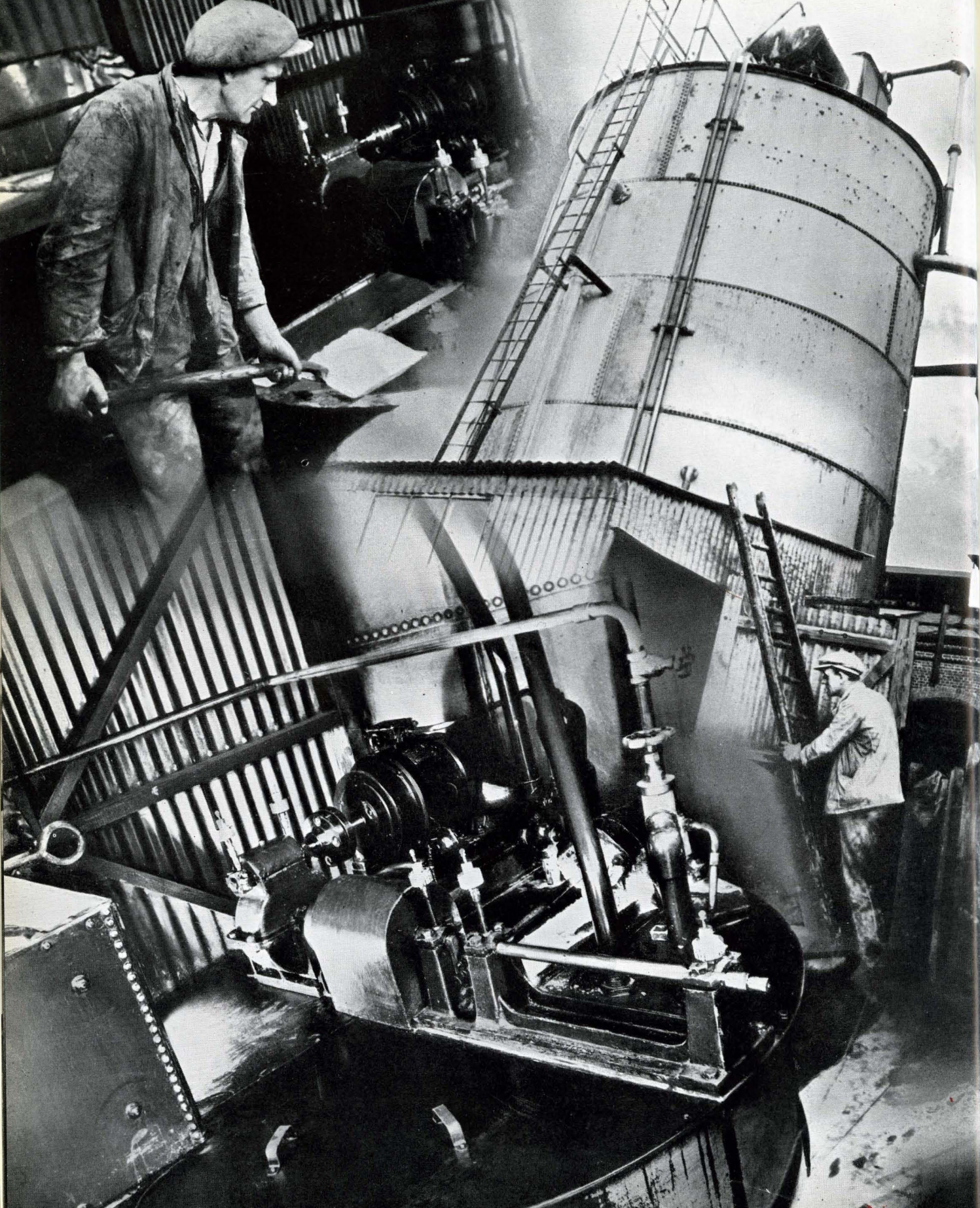

1. In the lime-soda process by means of the sodium hydroxide produced by the interaction of the two reagents used, i.e. hydrated lime and sodium carbonate; the sulphate, chloride, nitrate, etc., of magnesium finally appear as the corresponding sodium salt.
2. In the 'Alfloc' 'wayside' method of treatment the magnesium is removed as hydroxide, either by the direct use of caustic soda or by caustic soda produced in the boiler by the decomposition of the sodium carbonate.

#### REMOVAL OF SILICA

The lime-soda process of water softening frequently removes a portion of the silica present in natural waters, and the additional use of 'Alfloc' sodium aluminate in the lime-soda process increases the amount removed. A water which has been reduced to a low degree of hardness by the lime-soda-sodium aluminate process should give little or no trouble due to calcium silicate scale in locomotive boilers operating at low pressures, as the greater part of the residual silica usually remains in solution in the boiler water. It is interesting to note, however, that the sodium aluminate which is fed into the boilers where the 'Alfloc' system of 'wayside' treatment is used, precipitates the silica in a flocculent form inside the boiler. Hence, it is a definite advantage for locomotives to receive feed-water partly from lime-soda plants and partly from 'wayside' treatment plants, since a frequent cause of sludge adhering as scale is the cementing action of small percentages of silica or calcium silicate.

It is important to remember that quick limes may contain silica, and the use of quick limes of inferior quality in the lime-soda process of softening may increase the silica content of the softened water to a dangerous level. Many hydrated limes contain only small quantities of silica, and the use of a high grade hydrated lime such as 'Limbox' is therefore desirable.

#### *General Methods of Treatment*

Realising the need for water treatment, some railways have experimented with the addition of mixtures of chemicals, frequently of unknown composition, to the tenders of the locomotives; the results have often been disappointing, owing to lack of appreciation of the principles involved, and the economies anticipated have not been achieved. Moreover, in such cases, unexpected difficulties, such as increased priming, have been encountered.

The systems of treatment described in this booklet have been proved to be successful in practice and have been designed not only to avoid the difficulties mentioned above, but, in addition, to improve existing methods of treatment.

#### **Choice of Water Supply and Method of Treatment**

In the first place, it is important to ensure that the sources of supply are the best available, or in other words, contain the minimum of the impurities mentioned on page 17. It is then necessary to determine the best method of treatment for each supply.

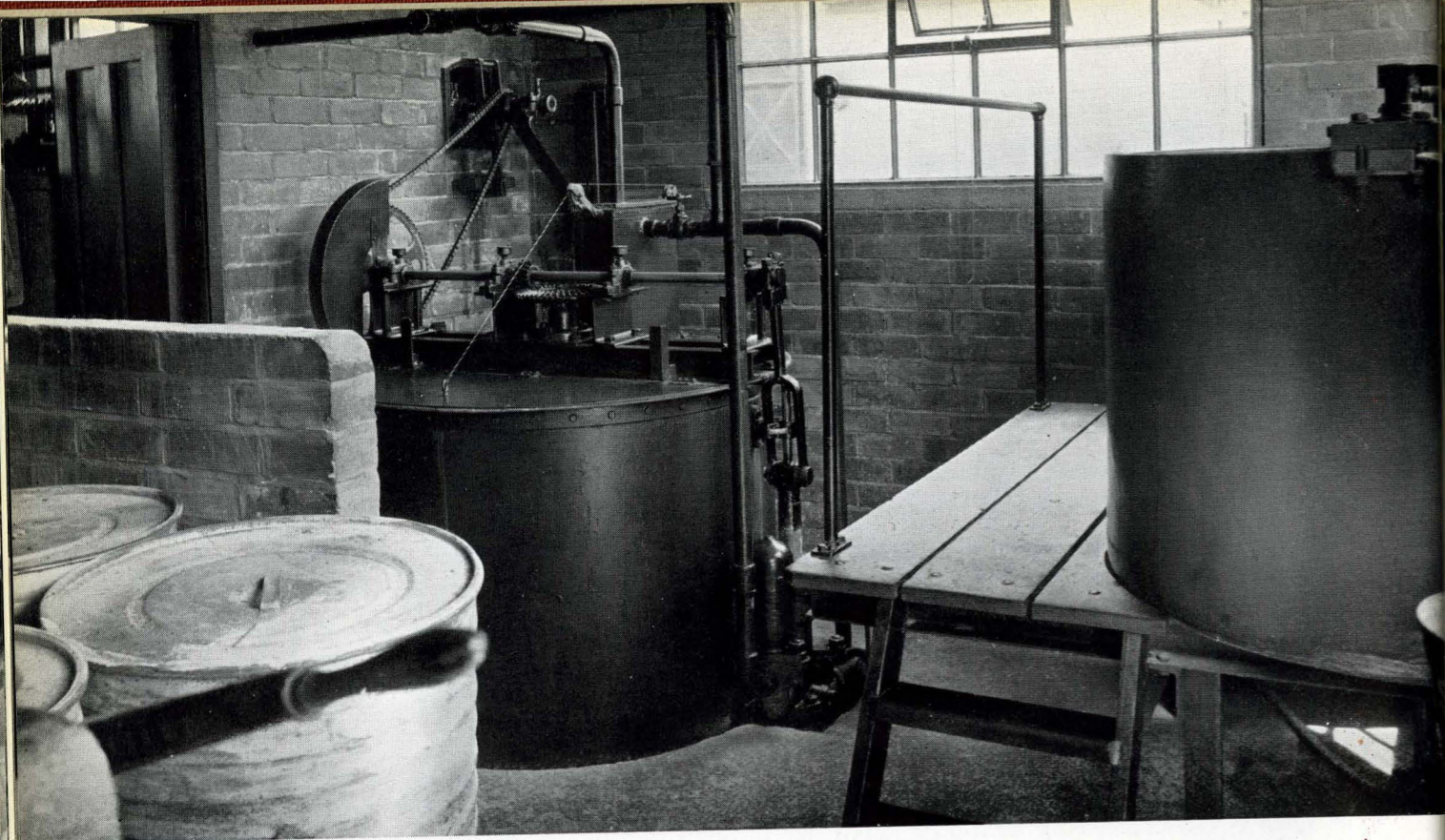

Reserve chemical reagent tank of Lime-Soda Softening Plant.

Main chemical reagent tank of the same plant showing solenoid operated proportioning unit. *Bristol Softening Plant, London Midland & Scottish Railway Co., Ltd.*

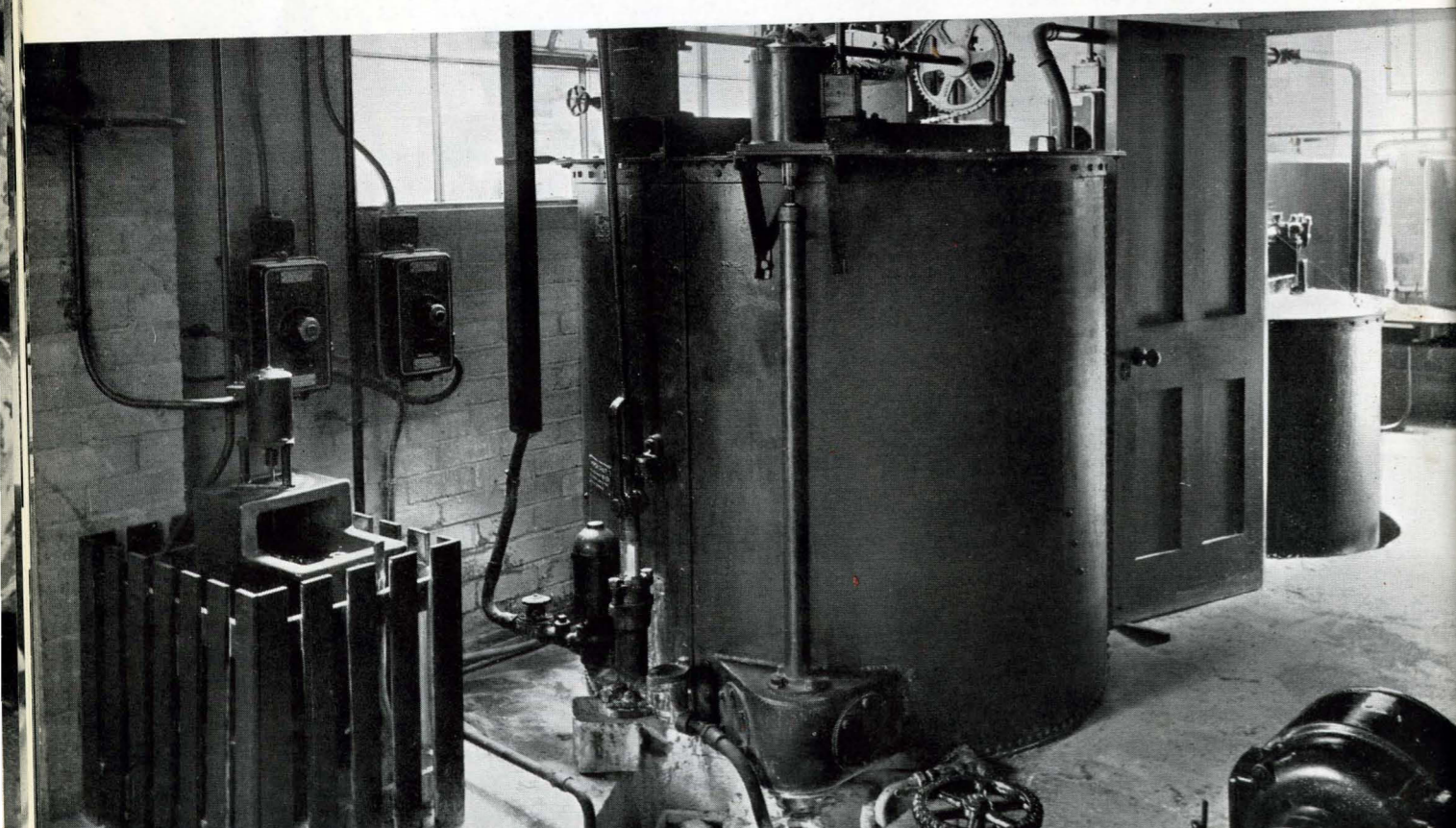

From the various processes described in this book, which have proved applicable to practically every type of water encountered, the choice of the most suitable method of treatment is determined by the following considerations:

1. The composition of the water to be treated.
2. The volume of water to be treated.
3. The location of the plant.
4. The method of supply.

Two main types of treatment are available, namely the method whereby the water supply is softened and conditioned in a suitable plant before it enters the locomotive, and the other whereby the water is actually treated in the locomotive itself. The former is known as 'External Treatment' and the latter as 'Wayside Treatment'.

### *External Treatment—The Lime-Soda Process*

It is generally accepted that the best method of softening and conditioning boiler feed-water in an 'external' plant is by the process known as the 'Lime-Soda' process. This process consists essentially in adding the correct quantities of reagents, which are usually hydrated lime and sodium carbonate, and in many cases sodium aluminate, to the raw water in amounts dependent on its composition. Cases sometimes occur in which it is necessary to employ special chemicals such as caustic soda, magnesium sulphate, calcium chloride, ferrous sulphate, etc., and Alfloc Limited will always be glad to advise on chemicals best suited to any particular type of water. One very interesting and important adjunct to this process is the addition of 'Alfloc' No. 58 Formula to the finally treated water in certain difficult cases (see page 43).

The chemicals must be mixed thoroughly with the raw water. The impurities are decomposed as described on pages 21-25 and precipitated. Adequate time is allowed for complete reaction and for the precipitate to settle and the clear water—filtered if necessary—is used as required. When considering the installation of a lime-soda softening plant, particular care should be paid to the following points of design:

- (a) The apportioning apparatus for adding reagents to the raw water should be strongly made and accurate over the range of flow of water through the plant. It is convenient to arrange it at ground level. It is also an advantage to run the plant at a constant rate of flow. In order to ensure this, it is possible to equip the treated water storage tank with a float which, at certain predetermined minimum and maximum levels, will rapidly open or close the main valve controlling the flow of raw water to the softener.
- (b) After the reagents have been dispersed throughout the raw water, a period of slow stirring or gentle agitation should follow in order to encourage flocculation and the rapid completion of the softening reaction. This period should occupy from 15 to 30 minutes, and the stirring should preferably be mechanical.

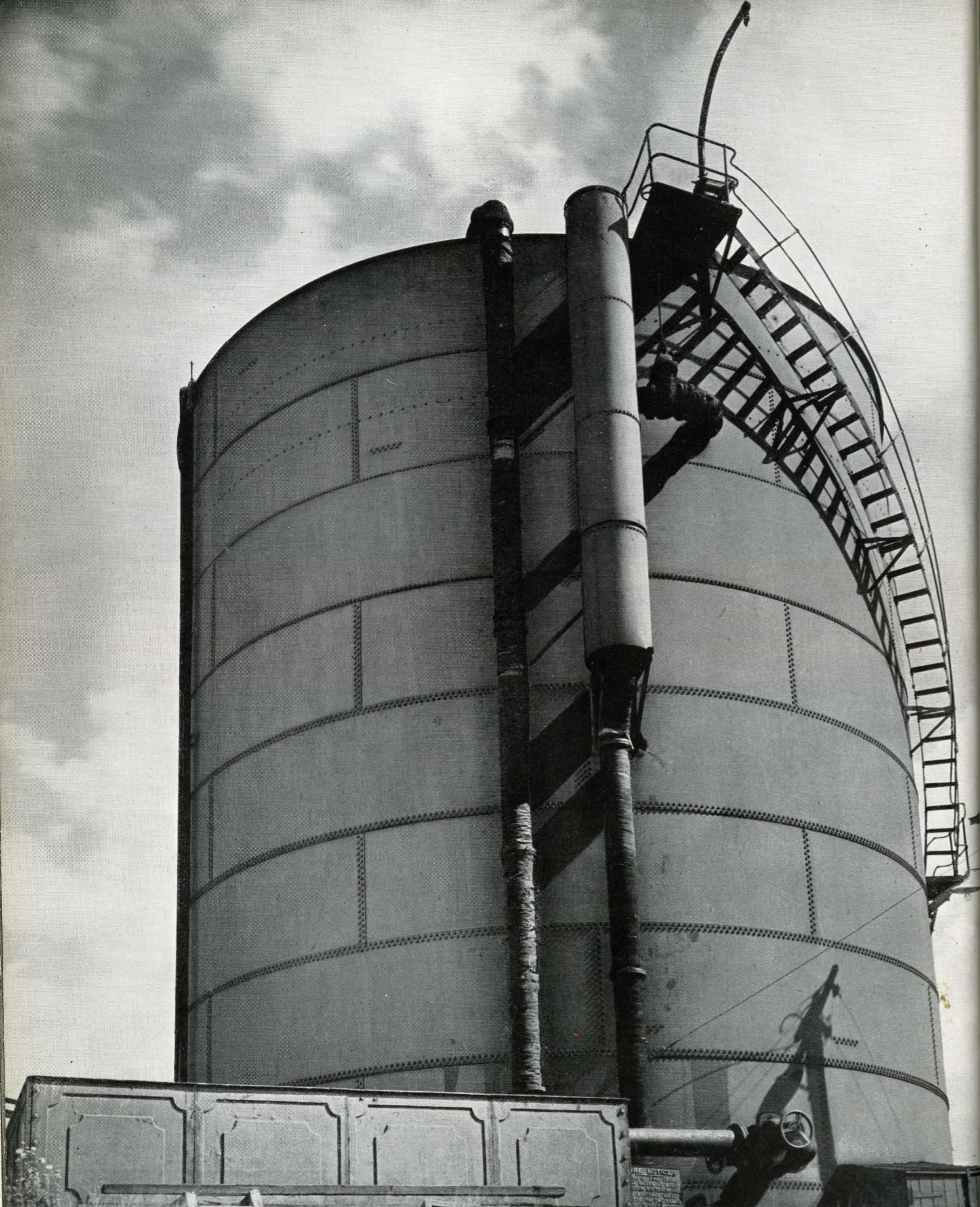

The lime-soda process has been established for many years; it is efficient, simple to operate, and is capable of softening successfully a wide variety of raw waters. It eliminates free and combined carbon dioxide, reduces the content of dissolved solids, and leaves the water in a suitably alkaline condition. The efficiency and flexibility of the lime-soda process of water softening have been greatly increased in the last few years by the use of the well-known chemical coagulant, 'Alfloc' sodium aluminate.

### Explanation of the Coagulating Effect of Sodium Aluminate

The following theory explains the effects obtained when sodium aluminate is used in the lime-soda process.

The water-softening reactions take place in very dilute solution, and under these conditions the sodium aluminate is partially hydrolysed, forming caustic soda ( $\text{NaOH}$ ) and aluminium hydroxide [ $\text{Al}(\text{OH})_3$ ]. The aluminium hydroxide exists partly as a colloidal suspension; in this fine state of subdivision the particles carry a negative charge relative to the 'medium' (i.e. the solution in which the particles exist), and readily aggregate with colloidal particles which carry a positive charge, e.g. magnesium hydroxide. It will be remembered that in the sections on pages 23 and 25, describing the removal of impurities, it was made clear that magnesium salts are converted by the reagents used into magnesium hydroxide. The mixed precipitate of magnesium hydroxide and aluminium hydroxide coagulates into large 'flocs'

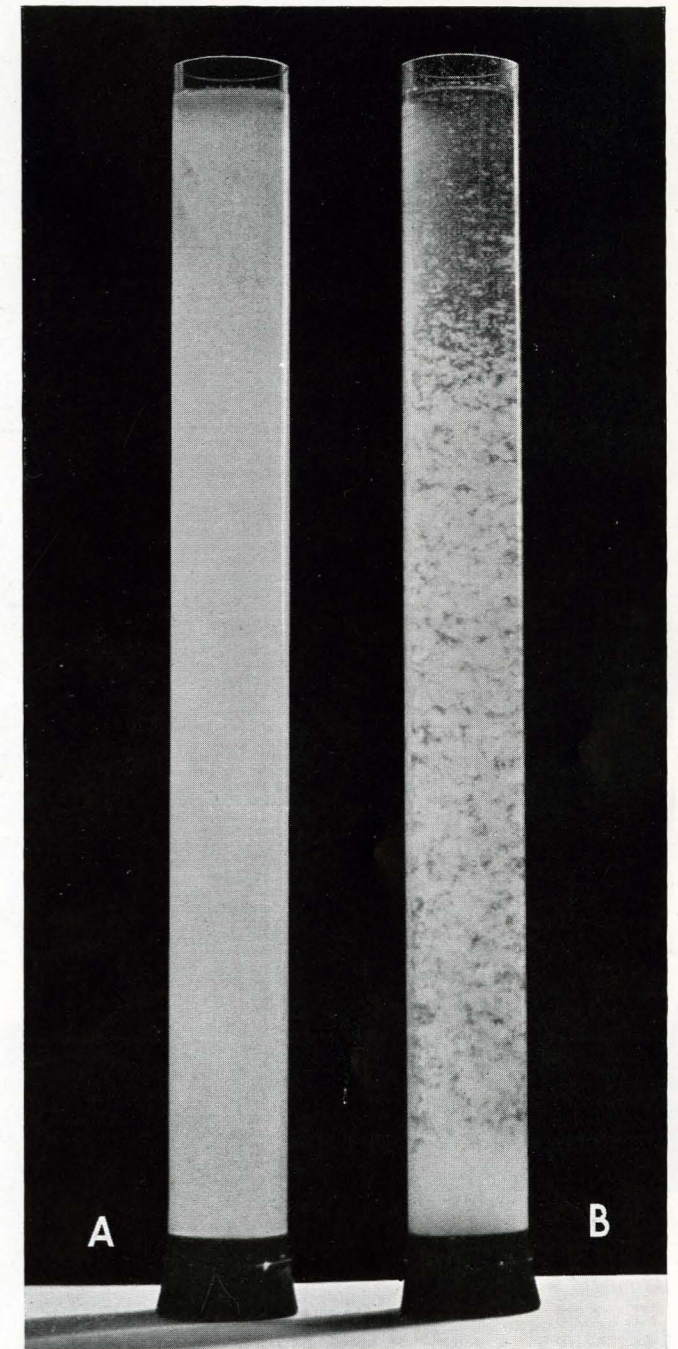

The above tubes contain the same raw water softened with identical quantities of lime and soda. To tube B has been added two parts per 100,000 of sodium aluminate, but none to tube A.



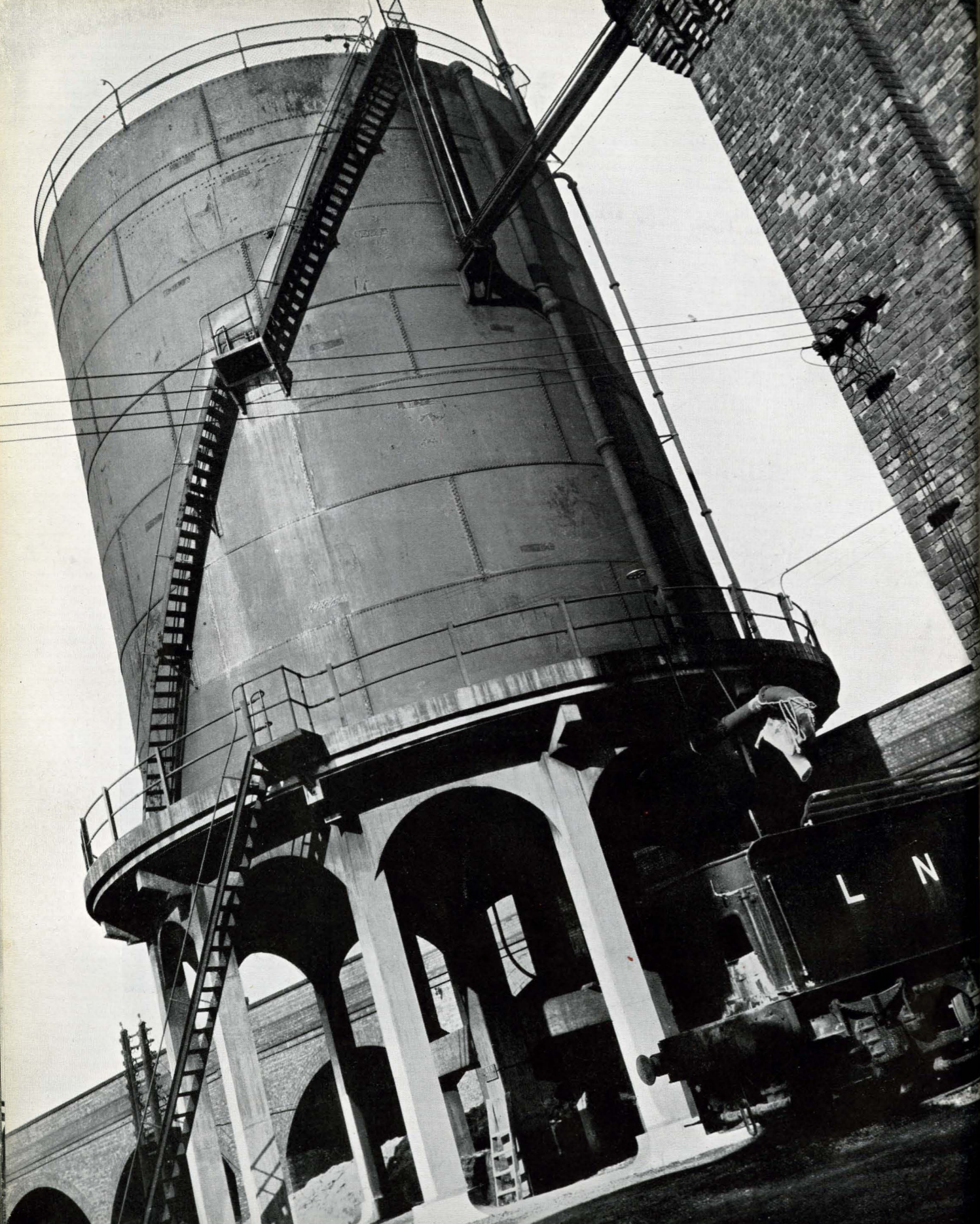

(see illustration B on page 31) which settle rapidly. The exact composition of this complex mixture is not known, and though certain theories have been advanced as to its possible composition, agreement has not yet been reached. The 'floc' is undoubtedly very different in physical properties either from magnesium hydroxide or aluminium hydroxide.

Another important effect is obtained when these large 'flocs' encounter fine particles of calcium carbonate which will not settle of their own accord, since they carry them down as a coherent precipitate together with all other suspended matter and such organic impurities as can be coagulated. The removal of both calcium and magnesium is therefore more rapid and complete when 'Alfloc' sodium aluminate is used in addition to the usual reagents, namely hydrated lime ('Limbox') and sodium carbonate.

In addition, since the presence of organic matter is found to interfere with the effective precipitation of calcium carbonate, the removal of organic matter by the use of sodium aluminate permits the softening reactions to proceed quickly to completion, thus preventing 'delayed precipitation' of calcium carbonate.

It is found that a clear, stable, softened water of lower residual hardness can be obtained in a shorter time by the use of sodium aluminate than when hydrated lime and sodium carbonate alone are used. As a result it has been found possible to increase the throughput of certain plants by as much as twenty-five per cent, a point to which full consideration should be given when designing new plants or employing sodium aluminate in existing plants. In addition, this lower residual hardness is obtained with a smaller excess of hydrated lime and sodium carbonate than is normally required.

The necessity for using 'Alfloc' sodium aluminate in the lime-soda process of 'external' softening cannot be stressed too strongly, and its cost is more than repaid by the numerous advantages obtained. Many railway authorities have proved that the full economies resulting from the use of 'external' treatment cannot be obtained unless sodium aluminate is used with the other reagents.

The use of water of the lowest possible degree of hardness for locomotive feed ensures that the quantity of salts entering the boiler, from which trouble may be experienced, is reduced to a minimum, and this is of considerable importance when it is realized that each grain of hardness in the feed-water of the average English Pacific type locomotive represents about a quarter of a ton per annum of troublesome salts.

In addition to producing a low degree of hardness, it is necessary to provide a small excess of alkalinity in the feed-water for two reasons:

- (a) To ensure that the residual hardness in the boiler water is zero, so that scale formation may be prevented.
- (b) To maintain the alkalinity of the boiler water at approximately twenty per cent of the soluble salts concentration in order to minimize corrosion.

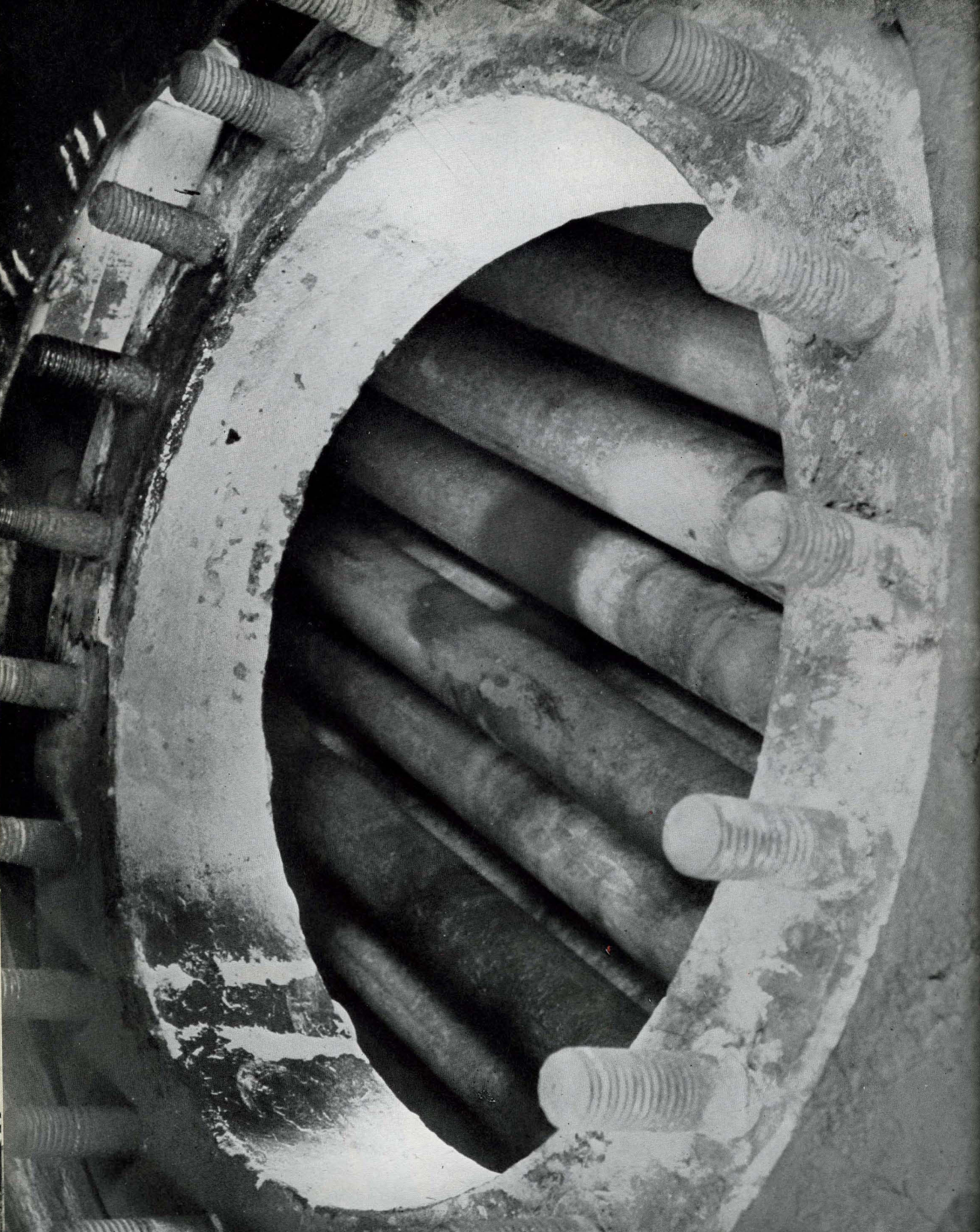

## Summary of Improvements Due to the Use of 'Alfloc' Sodium Aluminate in the Lime-Soda Process

The chief advantages obtained by the use of 'Alfloc' sodium aluminate in improving the efficiency of the lime-soda process of softening may be summarized as follows:

1. Low residual hardness with minimum excess alkalinity in the treated water.
2. Rapid sedimentation, and quicker and more complete softening reactions, often permitting an increase in maximum output of the plant.
3. Efficient removal of magnesium salts and reduction of the corrosion troubles associated with the presence of magnesium salts in water.
4. Reduction of silica content in the treated water.
5. Elimination of 'after-precipitation', thereby securing freedom from incrustation in pipe lines, injectors, water pumps, economisers, etc.
6. Softening plant filters are kept cleaner, giving longer life and less frequent back-washing.
7. The 'floc' formation improves the removal of colour and turbidity from the raw water; water supplies such as local streams, etc., which have hitherto been regarded as unsuitable for certain purposes, may often be satisfactorily treated to give a properly conditioned supply, at low cost.
8. The sludge from the softening plant which must be run to waste periodically is more fluid and does not tend to 'pack'. It therefore flows out easily through the sludge-cock. This facilitates disposal through existing drainage systems, etc., or pumping to, and filtration by, a filter press.

*By the correct use of a lime-soda-sodium aluminate softening plant, a water can be produced which is of minimum hardness, and which is non-corrosive, clear, stable, and of the correct degree of alkalinity. It is a method which should be adopted, wherever possible, and gives excellent results with practically all types of waters.*

Photograph taken from bottom manhole showing interior of Pacific type Locomotive after 60,000 miles running on water softened by the Lime-Soda-Sodium Aluminate process. Owing to absence of scale and corrosion it was undesirable to remove tubes, and a photograph taken from a similar position to that on page 12 could not therefore be obtained. *London & North Eastern Railway Co., Ltd.*



## **'Wayside' Treatment by the 'Alfloc' System**

The removal of the impurities in natural waters in an 'external' treatment plant before the water enters the boiler is a process which is mainly suitable when large volumes of water have to be treated, and where there is suitable labour to look after the plant.

In many cases, however, it may be necessary to treat a relatively small volume of water in isolated positions where adequate control of a large softening plant would be difficult to carry out, and where the overheads and maintenance cost of an external plant would make its erection uneconomic. An alternative method must, therefore, be adopted, and this is provided by the 'Alfloc' system of 'wayside' treatment.

This system gives the same advantages in practice as the lime-soda-sodium aluminate method of water treatment, the difference being that in the 'Alfloc' system of 'wayside' treatment part, or all, of the impurities are allowed to enter the boiler, where they are precipitated as harmless, non-adherent sludge ('floc') by suitable reagents previously added to the water and also by the heat; they are then removed in the boiler blowdown or water change. The necessary reagents are fully described in the Appendix.

The 'Alfloc' system of 'wayside' treatment can be carried out in two distinct ways:

- (a) By 'partial precipitation.'
- (b) By 'deferred reaction.'

The method chosen will depend on the type of water treated and whether facilities exist for 'partial precipitation.'

In both cases it is unnecessary to provide chemicals for removing the temporary hardness, since any temporary hardness entering the boiler is automatically removed by the action of heat. A sufficient degree of alkalinity is imparted to the raw water by the addition of suitable sodium compounds (their composition depending on the type of water to be treated) which convert the soluble calcium and magnesium salts comprising the permanent hardness into the corresponding soluble sodium salts; insoluble calcium and magnesium precipitates are formed and a small excess of soda alkalinity is left which builds up in the boiler water and provides the necessary safeguard against corrosion. The mechanism of removal of the calcium and magnesium salts is described below.

### **(a) 'Wayside' Treatment by the 'Partial Precipitation' Method**

This method is recommended where suitable storage and settling facilities are available in the form of a 'raw' water storage tank, which must be sufficiently large to allow the precipitate to settle. With small storage tanks of the 'parachute' type, or where the water is taken direct from the mains, the 'deferred reaction' method should preferably be adopted.

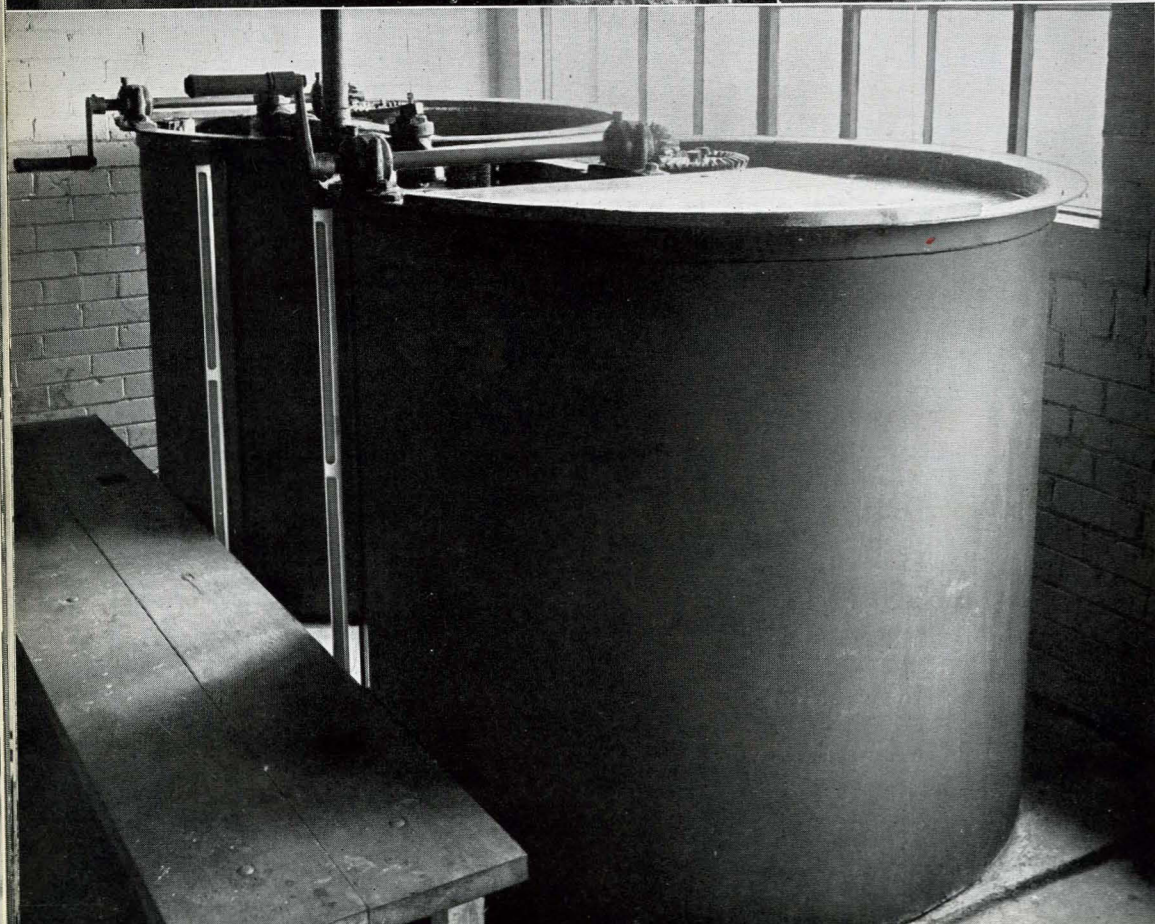
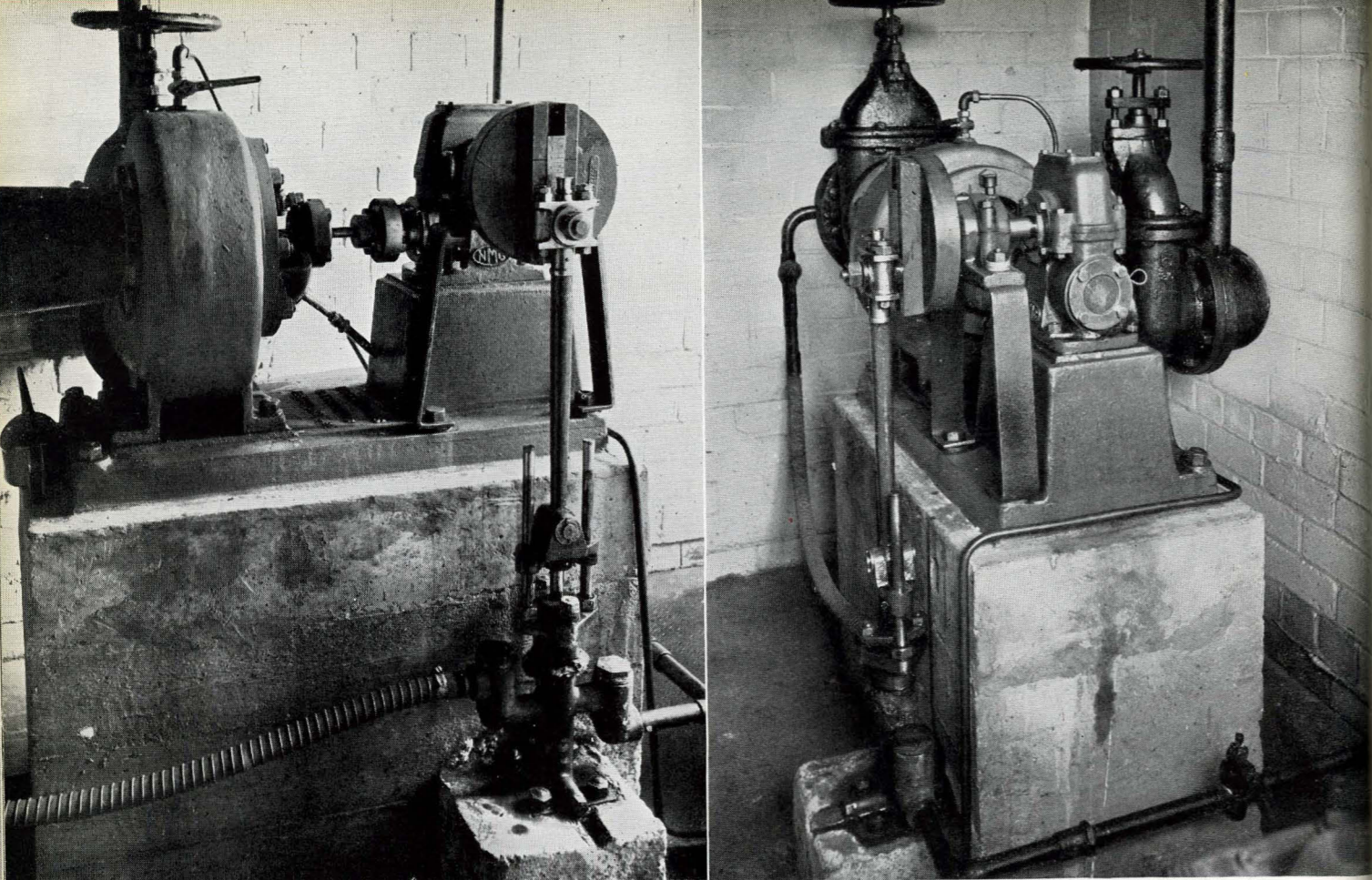

Views of water motor proportioner and mixing tanks for feeding chemicals used in the deferred reaction method of wayside treatment. *Huddersfield Plant, London Midland & Scottish Railway Co., Ltd.*

In the 'partial precipitation' method, sodium aluminate is used with the precipitating reagents (caustic soda and/or sodium carbonate) which are added to the water continuously as it enters the storage tank. The success of the treatment depends essentially on the use of sodium aluminate, since it enables the maximum precipitation and settling of the calcium as carbonate, and of the magnesium as hydroxide, to occur in the short time available before the water leaves the storage tank. In this system of treatment the necessary alkalis and the sodium aluminate can be provided in the following ways:

- (a) 'Alfloc' liquors with or without additional alkalis.
- (b) Solution of solid chemicals made up on site.
- (c) 'Alfloc' Briquettes.

The chemicals and the apparatus for feeding them are described in the Appendix. The method best suited to any particular plant depends upon its location, method of supply, relative cost of treatment, and the type of labour available; Alfloc Limited will advise on this matter.

The net result of the 'partial precipitation' process is a reduction in the hardness—the amount depending upon the type of water and reaction time available; the hardness which remains then exists completely as temporary hardness, either as bicarbonate or carbonate. The greater the proportion of the latter, the greater the likelihood of continued precipitation. The alkalinity figure must be higher than that of the residual hardness at this stage.

The water is stabilized and further chemical reaction is prevented (until the water enters the boiler)—thus avoiding incrustation in feed-line pumps, injectors, etc., by the addition of a suitable quantity (usually  $\frac{1}{2}$  to 1 grain per Imperial gallon) of 'Alfloc' No. 58 Formula, at a point where the water leaves the storage tank.

This stabilization treatment is carried out by the use of 'Alfloc' No. 58 Briquettes, or by the use of a solution of 'Alfloc' No. 58 Powder made up on site. These chemicals and the apparatus for feeding them are described in the Appendix.

When the water enters the boiler, the chemical reactions are finally completed and the residual temporary hardness is precipitated as calcium carbonate and magnesium hydroxide in the form of a flocculent sludge, which does not adhere to, or cake on, the heating surfaces. The resulting boiler water is thereby freed from scale-forming and corrosive salts, and its correct alkalinity is maintained. Care must be taken to control the concentration of the dissolved salts (see page 47).

The amount of sludge formed in the 'raw' water storage tank naturally depends upon the type of water treated. It precipitates in a form which can be easily run off through a sludge valve at the bottom of the tank; in practice it is usually found that the quantity formed gives very little trouble in its removal, and that the sludge valve, in some cases, may not be used for several weeks.

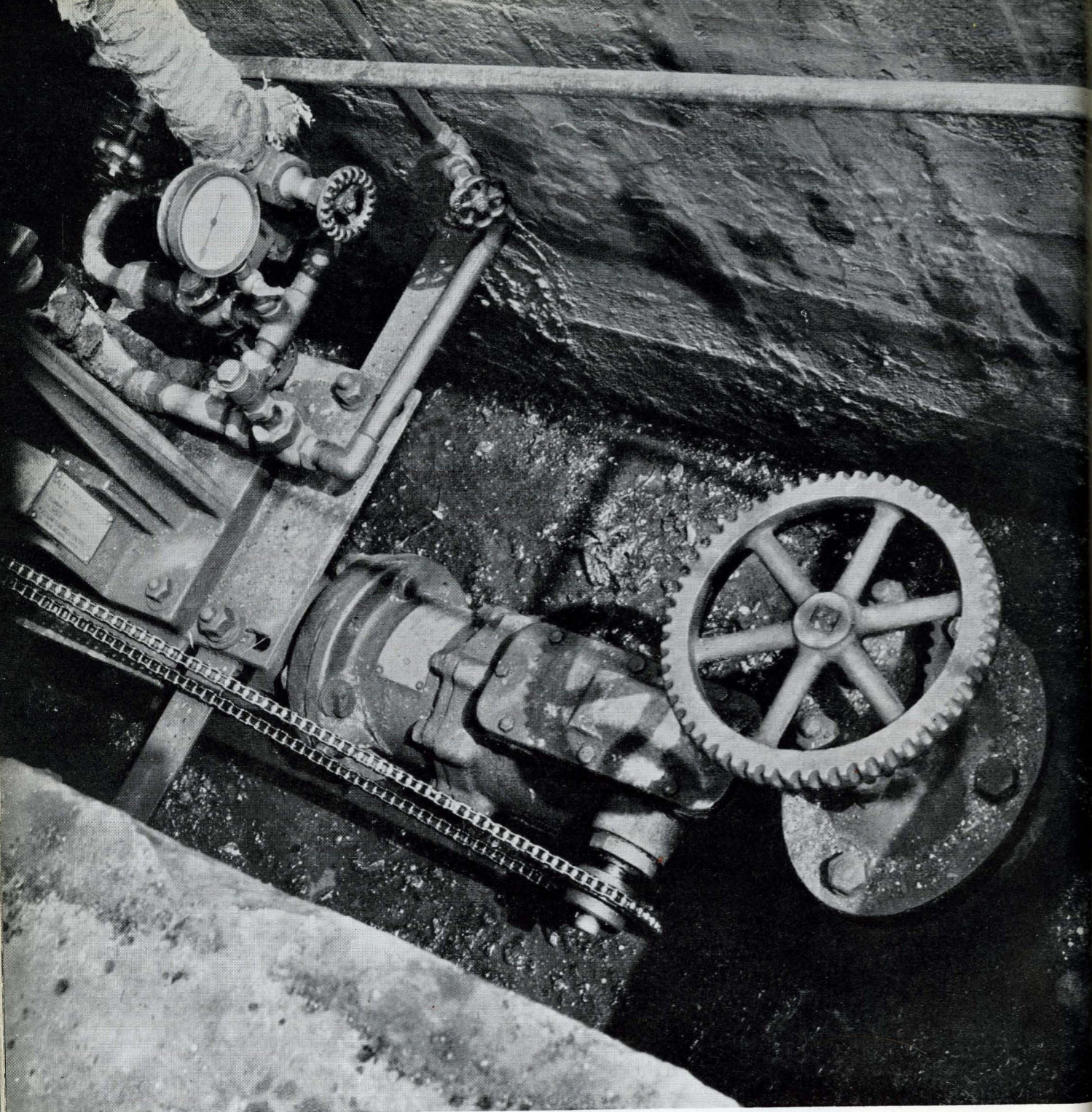

Water motor and pump for deferred reaction method of wayside treatment using 'Alfloc' Liquors (see page 36). *Wentworth Plant, London & North Eastern Railway Co., Ltd.*

### *(b) 'Wayside' Treatment by the Deferred Reaction Method*

Where there are no storage facilities which can be used during the treatment, the 'deferred reaction' method must be substituted for the 'partial precipitation' method. The 'deferred reaction' method of 'wayside' treatment is exactly the same in chemical principles as the 'partial precipitation' method just described; certain inhibitors, however, are added to the mixture of alkalis and coagulants which prevent any precipitation taking place before the water reaches the boiler. For this purpose Alfloc Limited can supply chemicals which can be dissolved on site, though in most cases the use of briquettes will be found to be more convenient. After the water enters the boiler the reaction and results are precisely the same as those described in the preceding section, "'Wayside' Treatment by the 'Partial Precipitation' Method'. The briquettes required in this method and the apparatus for feeding them are described in the Appendix.

### *Comparison of the two methods*

The full value of the 'Partial Precipitation' method of 'wayside' treatment is obtained with water relatively low in temporary hardness and high in permanent hardness, as a fair proportion of the impurities can be removed from this type of water by external precipitation. With waters which are either very soft, or relatively high in temporary hardness and low in permanent hardness, very little precipitation is obtained by the 'Partial Precipitation' method of 'wayside' treatment. The chemicals used in the 'Deferred Reaction' method, on account of the inhibitors they contain, are, generally speaking, more expensive than those used in the 'Partial Precipitation' method of 'wayside' treatment, and it is therefore advisable to use the latter method in all cases where a storage tank is available for the following reasons:

1. It is usually cheaper than the deferred reaction method of treatment.
2. Some elimination of impurities is obtained outside the boiler.
3. The storage tank tends to balance out any slight irregularities in the feed from the proportioning apparatus.

It should be emphasized that, whichever method of 'wayside' treatment is adopted, the quantity of Soda ( $\text{Na}_2\text{O}$ ) in the chemicals used is strictly proportional to the permanent hardness in the water, though a small additional excess is employed to give the necessary alkalinity to the boiler water and to prevent corrosion.

Alfloc Limited will advise on the choice of 'wayside' treatment to adopt, and the type and quantity of chemicals to use for any particular water station, provided adequate data are given regarding the station.

### **Other Problems**

The methods which are available for overcoming the troubles due to scale formation and most types of corrosion in railway locomotives have been outlined. There still remains the question of dealing with the following problems:



Examples of corrosion on Locomotive tubes showing 'necking' or 'grooving', and 'pitting'. London Midland & Scottish Railway Co., Ltd.

- (a) Cases of corrosion which persist in spite of the correct alkalinities being carried in the boiler water.
- (b) Priming.

### *(a) The Problem of Corrosion*

In general, corrosion (i.e. pitting and ringing) can be prevented by the maintenance in the boiler water at all times of a definite alkalinity. Experience leads to the belief that the greater part of the corrosion can be eliminated if the caustic alkalinity of the boiler water (expressed as NaOH) is maintained at about 10 to 15 per cent of the sum of the sodium chloride and sodium sulphate contents of the boiler water. This formula is accepted by the American Railway Engineering Association<sup>1</sup> and its application has been found by many railways to give freedom from corrosion. For general control purposes it is usually sufficient to maintain the total alkalinity (to methyl orange) of the boiler water at about 20 per cent of the total dissolved solids; and always above a minimum value of about 25 grains per gallon. The caustic alkalinity, however, which is the most important preventive agent, should be checked as frequently as possible.

In some cases, however, corrosion may still persist, and as the maintenance of still higher alkalinities is not desirable on account of (1) the high blowdown it would involve, or the necessity for more frequent washing out; or (2) its liability to cause caustic embrittlement (see page 19), other methods for overcoming this trouble must be considered. This problem, which has received the attention of our Research Laboratories, has resulted in the development of the useful product known as 'Alfloc' No. 58 formula.

#### THE USE OF 'ALFLOC' NO. 58 FORMULA

By the addition of a small quantity of 'Alfloc' No. 58 formula to the water leaving the water treatment plant (at the same time maintaining the alkalinities in the boiler water at a reasonable figure), the last traces of corrosion can be eliminated. The use of 'Alfloc' No. 58 formula may sometimes permit a reduction in the excess alkali provided by the softening plant, if this has previously been raised unduly with a view to preventing corrosion. The No. 58 formula is a complex mixture containing definite proportions of selected tannins and phosphates, and is supplied either in briquette form or powder form (see Appendix). It may be apportioned to the treated water either by a by-pass feeder or (dissolved in water) by a water or electric motor and pump. The amount of treatment normally employed varies with local conditions, and in general a quarter of a pound to one-seventh of a pound per thousand gallons is used.

A further advantage of the product is its stabilizing effect on unstable waters, and it is therefore of very great assistance in overcoming injector incrustation. The photographs overleaf show the condition of two boiler tubes after a test in one of the small experimental boilers in the Research Laboratories of one of our associated companies.

<sup>1</sup> *Bulletin American Railway Engineering Association*, vol. 35, No. 362, Dec. 1933, p. 263

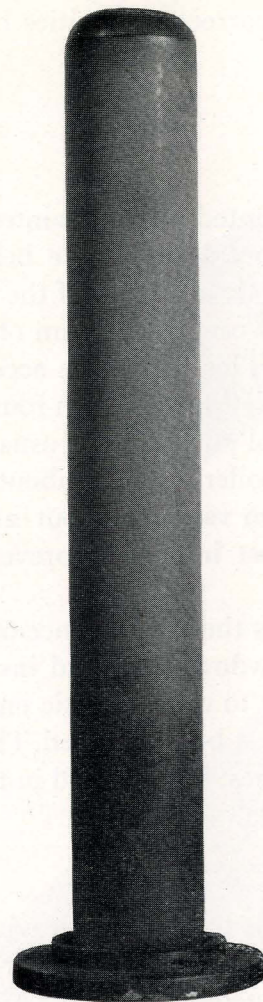

Boiler tubes after one week's test. Left hand tube was in softened corrosive water using no 'Alfloc' No. 58 Formula. Right hand tube was in softened corrosive water containing 'Alfloc' No. 58 Formula.

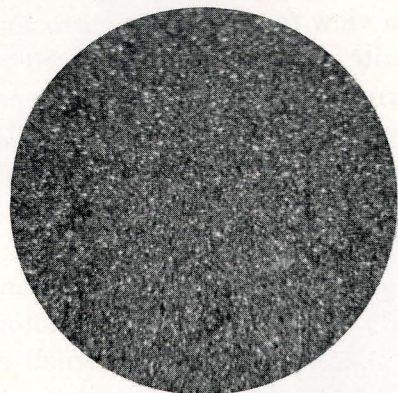
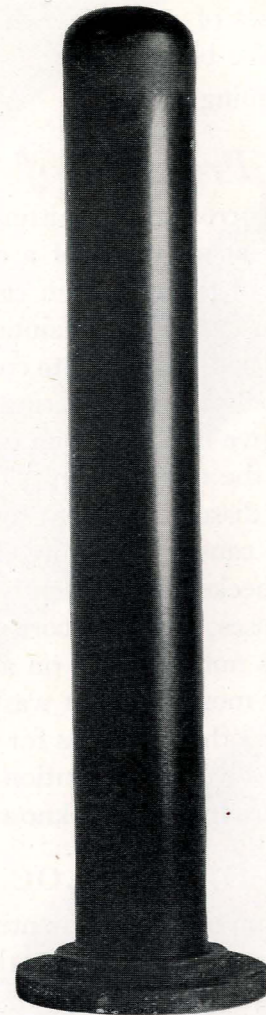

Photomicrograph  $\times 50$  diameters of surface of tube after test in water containing no 'Alfloc' No. 58 Formula. Note general corrosion.

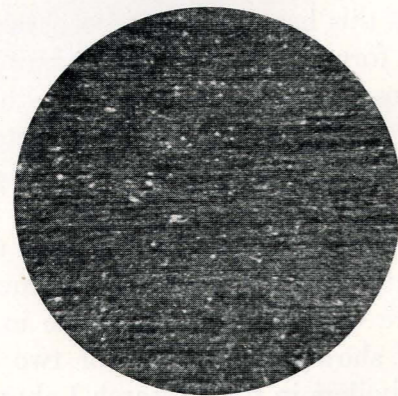

Photomicrograph  $\times 50$  diameters of surface of tube after test in water containing 'Alfloc' No. 58 Formula. Note original tool marks and absence of corrosion.

The tests were run consecutively, using a corrosive water softened to a low degree of hardness and carrying the correct degree of alkalinity. In one test, however, 1 grain per gallon of 'Alfloc' No. 58 mixture was added to the water, but in the other this was omitted. Before insertion in the boilers both tubes, which were of exactly similar composition, were polished, though the machine tool marks were plainly visible in both cases. Each experiment was run for a week continuously. At the end of this period the difference in appearance of the two tubes was very striking. The tube used for the run with water containing 'Alfloc' No. 58 formula was a smooth jet black, and the original tool marks were plainly visible. There was no sign of corrosion. The tube which had been immersed in the water containing no 'Alfloc' No. 58 formula was thinly coated with a deposit of rust, and the original tool marks had entirely disappeared.

It is suggested that the action of 'Alfloc' No. 58 formula in preventing corrosion is as follows:

While most of the oxygen in a feed-water will be driven off rapidly into the steam immediately on entering the boiler, especially if top feed is employed, a very small amount of residual oxygen will be present in the main body of the water, due to the fact that fresh oxygen is continually entering with the feed-water. Consequently, there will always be traces of dissolved oxygen present. When 'Alfloc' No. 58 treatment is used two reactions take place. Firstly, there is a solution of tannin in the strongly alkaline boiler water which probably reduces the oxygen content, but a second and more important action is the combination of phosphates and tannins to produce a thin film of protective material on the surface of the steel; this is believed to be a thin film of phospho-tannate of iron, though the composition is not as yet definitely known.

### *(b) Priming*

The evils of priming are too well known to need description here. A useful and interesting discussion of this phenomenon is given in J. S. Hancock's paper, 'Locomotive Feed Water Treatment' (*Journal of the Institution of Locomotive Engineers*, March/April 1937). Though some engineers have attributed the evils of priming to the use of softened water this is based on an entire misconception of the facts. The evidence has almost invariably shown that the wrong softening treatment has been applied to the particular water in question, or alternatively that the correct method of treatment has been chosen but incorrectly applied. In some instances (particularly where water treatment has not previously been used), the correct method of treatment was chosen, but its success was prevented by failure to wash out the boiler more frequently—an operation which is always necessary until all the old scale has been removed.

Many theories have been advanced to explain the possible causes of priming, but so far no completely satisfactory explanation has yet been evolved. A large number of factors have to be taken into account as boilers operate under widely differing conditions. Boiler design, the water level in the boiler, and the point at which steam is taken off, certainly exercise

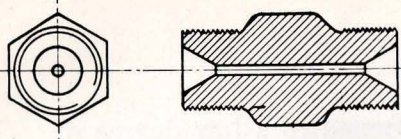

ORIFICE  
STAINLESS OR  
CHROMIUM STEEL

ORIFICE NO.	ORIFICE DIA.
1	1/32"
2	1/16"
3	3/32"
4	1/8"
5	5/32"
6	3/16"
7	7/32"
8	1/2"
9	9/32"

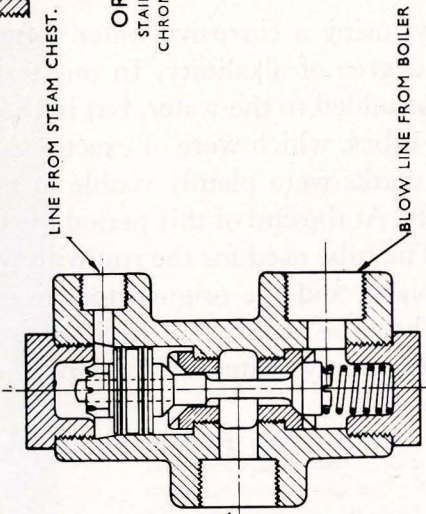

'ALFLOC' AUTOMATIC  
BLOWDOWN UNIT

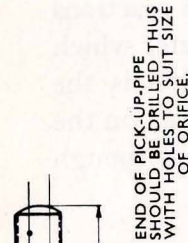

END OF PICK-UP-PIPE SHOULD BE DRILLED, THUS WITH HOLES TO SUIT SIZE OF ORIFICE.

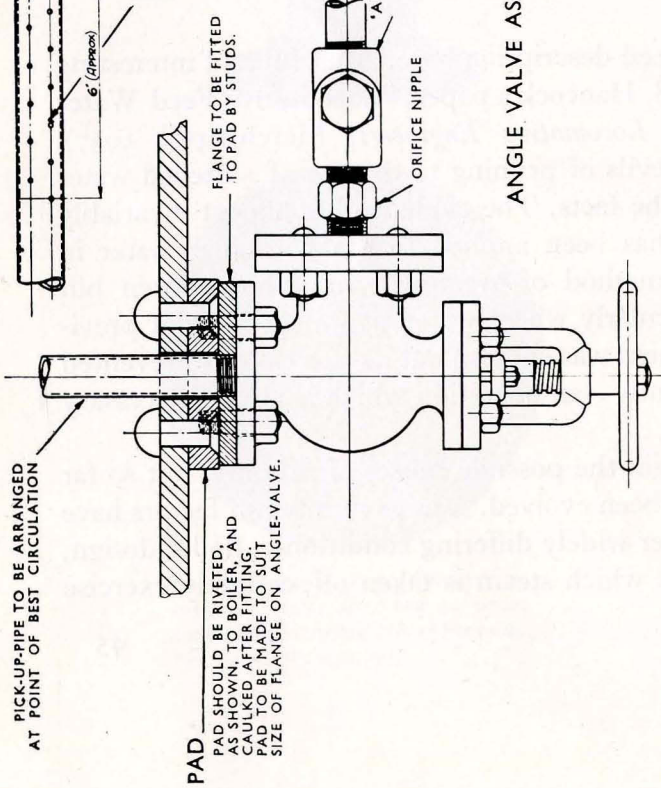

ANGLE VALVE ASSEMBLY

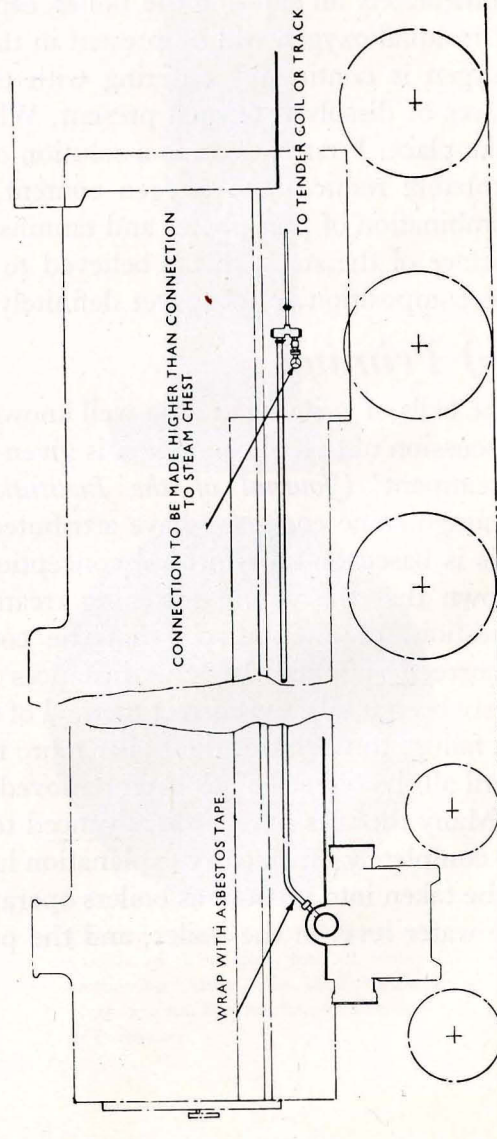

GENERAL ASSEMBLY OF 'ALFLOC' AUTOMATIC BLOWDOWN VALVE ON LOCOMOTIVE BOILER

important effects, though the actual composition of the boiler water itself is known to play an important part in the question of priming.

As a result of prolonged investigation it is believed that the solids dissolved in the water exercise a major influence on priming, but it is also felt that the presence of uncoagulated and very finely divided suspended solids play an important part. The latter may be formed in several ways.

- (a) Action of heat on incompletely softened water.
- (b) Use of incorrect methods of treatment.
- (c) Failure to use the correct coagulants in 'external' and 'wayside' treatment.

The obvious remedy for (a) is to reduce the hardness of water treated by external softening to a minimum (preferably one degree or lower), and this step also reduces any tendency to scale formation or corrosion. With regard to (b) and (c), these difficulties are avoided by the methods of 'external' and 'wayside' treatment recommended in this booklet.

### SOLUBLE SALTS AND THEIR RELATION TO PRIMING

Both in the 'external' and 'wayside' method of treatment, permanent hardness (i.e. calcium sulphate, magnesium sulphate, etc.) is converted into the corresponding sodium salt, whereas, if untreated water is evaporated, the permanent hardness is deposited from solution as scale. It will thus be seen that, in general, the use of treated water as boiler-feed will cause the concentration of salts in the boiler to increase more quickly than with untreated water owing to the presence of these sodium salts. The priming concentration of the boiler water is therefore more rapidly approached and it is necessary to take steps to avoid this. Recourse may be made to more frequent 'water changes' or 'washouts', but more and more engineers are deciding that the most satisfactory solution of this problem is the installation of a systematic method of blowdown. This may be accomplished either by the intermittent system or by the automatic type of blowdown valve, of which a typical example is shown *in section* opposite.

### BLOWDOWN

Alfloc Limited will place at the disposal of any plant manufacturer or railway company full details of the construction of the valve shown opposite. This type of valve has proved very satisfactory in practice, but other types may be available which may give equally good results. By adopting a systematic method of blowdown priming can be prevented, as the soluble salts can be kept at the required concentration; the scale-forming salts (which have been precipitated as a flocculent sludge) are also removed and no sludge will build up between the tubes or stays. In addition, it is possible to extend the periods between washouts very considerably, e.g., a certain railway which was previously 'washing out' locomotives at the end of 500 miles running has now extended the running period to 5,000 miles; many locomotives on other railways are washed out at monthly intervals, whereas previously they required washing out every few days, thus greatly increasing the number of



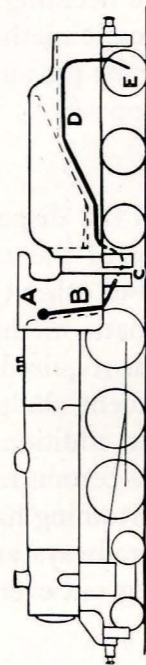
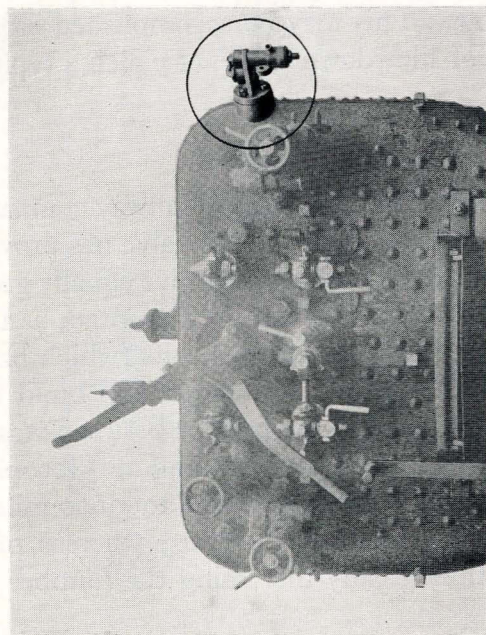
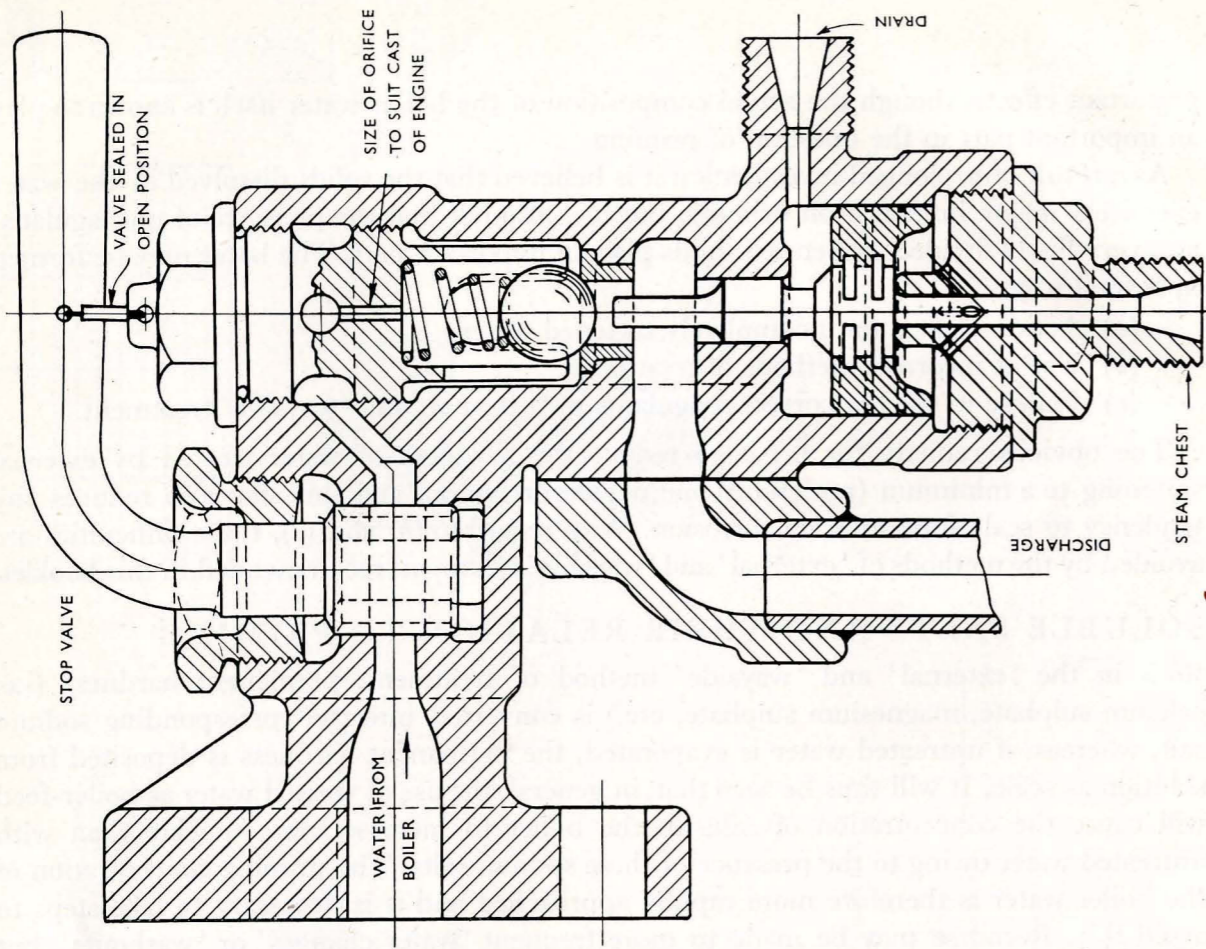

Continuous Blowdown valve as fitted to Boiler face plate of London Midland & Scottish Railway Company's Locomotives.

locomotives available. In addition, a satisfactory feature of this method of deconcentration is that the boiler water can be more readily maintained at its ideal composition.

#### A NET ECONOMY IN FUEL DUE TO CORRECT BLOWDOWN

The amount of water blown down will depend on the particular design of the boiler, the load, and operation of the train, and the composition of the feed-water. In general, the amount varies from 5 to 15 per cent of the water consumption. It may be suggested that this represents wastage of heat, since the blowdown water will be at the temperature of the boiler. It should be, therefore, realized that on an English express locomotive, operating at 250 lb. per square inch pressure and 600° F. superheat, a blowdown of 7 per cent of total water consumption represents only 2.1 per cent of the total fuel consumption. The fuel bill of the locomotives, however, will not necessarily increase, for, if heat recovery is practised, then of this 2.1 per cent about 50 per cent may be recovered, and thus the loss due to blowdown will be reduced to the order of 1 per cent. This is more than offset by the increased efficiency of the boiler due to the elimination of scale, and thus the net result is an economy in fuel.

In addition, the steam is drier, and the avoidance of wash-out and water changes gives a considerable saving in expenditure.

The continuous discharge of blowdown water to the track may be criticized from the following standpoints:

1. Effect on the operation of track circuits due to the possible increase in conductivity of the track caused by the salts discharged in the concentrated boiler water.
2. Possible deterioration of sleepers due to the discharge of the blowdown water.

As far as conductivity of the track is concerned, practical tests carried out by railway companies indicate that the effect is of no account, and no trouble whatsoever may be anticipated. The effect on the sleepers has been investigated by an American railway company, and it was established that, contrary to expectation, the sleepers were actually more resistant to wear, and their life was increased.

It is sometimes an advantage to equip the locomotive either with mufflers or centrifugal separators, especially when using intermittent blowdown, in order to dispose satisfactorily of the blowdown water. Such arrangements prevent any possibility of the blowdown water making coaches unsightly or obscuring the vision of the driver.

Many railways have a preference for the intermittent type of blowdown valve. Where the tender capacity of the locomotives is limited, intermittent blowdown may be resorted to at terminals and, if the locomotive is equipped with a muffler, noise is reduced to a minimum. The total cost of equipping large locomotives with automatic blowdown and heat recovery varies from £15 to £20 sterling.

#### HEAT RECOVERY

It is possible to recover a reasonable proportion of the heat of the blowdown water by passing the water through a coil in the tender of the locomotive, though complete heat



Descaled tubes after 12 months' service from Locomotives running on partially softened water. Note absence of corrosion and the presence of 'mill' scale. *London & North Eastern Railway Co., Ltd.*

recovery is not possible, as the temperature of the feed-water is limited by the maximum temperature at which the injector will successfully operate.

### ***Treatment of Highly Saline Waters***

There are sometimes watering points on a railway system where the water contains initially a high content of soluble salts, such as sodium chloride and sodium sulphate, and occasionally sodium bicarbonate (see page 19). Such waters when evaporated in a locomotive rapidly reach priming concentration, and in consequence the locomotives have to be washed out at frequent intervals. The more orthodox methods of treatment, external or wayside, remove the scale-forming and corrosive salts from the water, though the priming difficulty still remains. Assuming, therefore, that no alternative supply is available, the best method is to treat the water in an 'external' water treatment plant, thus rendering it non-scaling and non corrosive, and then to apply 'Alfloc' Antifoam to the locomotive during operation. If the water is not one which is used in large quantities and the scale and corrosion problems are not of major importance, then the use of Antifoam alone may be considered. The use of this material is recommended only if the methods already described in this booklet have, after due consideration, proved unsuitable.

'Alfloc' Antifoam is a highly dispersed emulsion of tannins and castor oil, stabilized with other reagents. It has been proved in practice to give extremely effective results, and this is due not only to its formula, but also to the care used in its manufacture. A supply of Antifoam in a suitable container should be carried by each locomotive working in the highly saline district, and the driver should be provided with a measuring device which gives the correct quantity of Antifoam with which to treat a known volume of water. The amount of Antifoam used varies between one-twentieth to one-tenth of a pound to every 1,000 gallons of feed-water. After the tender has been filled, the appropriate quantity of Antifoam should be dissolved in a bucket of warm water and added to the tender. This should only be done immediately before use, otherwise the emulsion will be spoiled. Once the application of Antifoam has been commenced it is imperative to continue its use until the locomotive is washed out, otherwise priming may recommence.

### **Recommendations**

If the methods of treatment which have been described are to be operated successfully on any railway system particular attention should be paid to the following:

- (a) Treated water from 'external' lime-soda-sodium aluminate plants must be reduced to the lowest possible degree of hardness and should be of the correct alkalinity.
- (b) 'Wayside' treatment plants should be adjusted to give the requisite amount of excess alkalinity recommended by Alfloc Limited for each particular case.

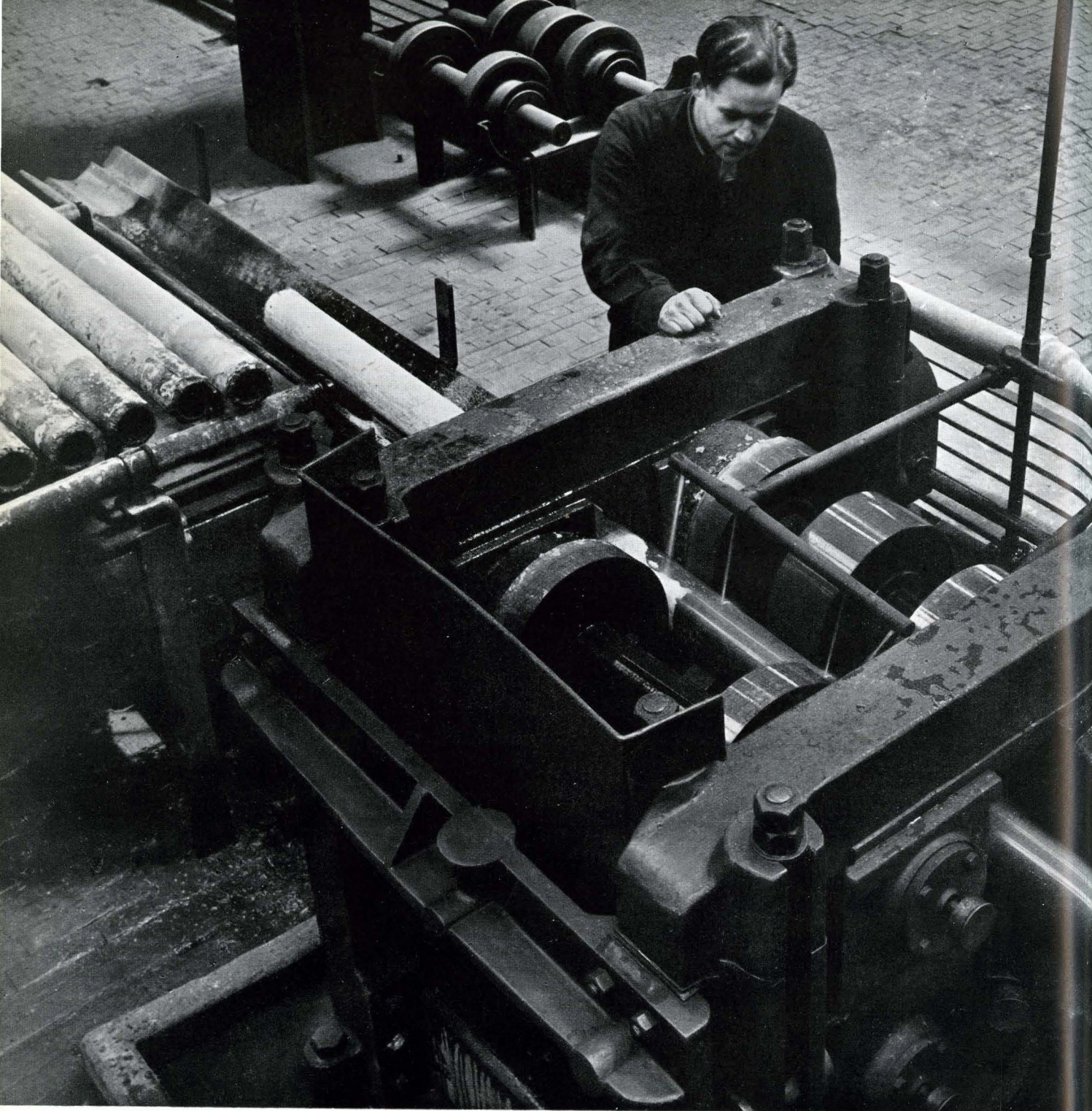

Scaled Boiler Tubes being cleaned mechanically. Water softening avoids this difficulty and preserves the life of the tubes.

5. Complete chemical analysis of the water (taking particular account of possible variations in composition).

Under this heading the following data are required: Total hardness—calcium hardness—magnesium hardness—alkalinity to methyl orange—total dissolved solids—total chloride, sulphate, and silica content, and free carbon dioxide ( $\text{CO}_2$ ). The temporary and permanent hardness should both be expressed in terms of grains of calcium carbonate per Imperial gallon.

If any difficulty is experienced in obtaining the chemical analysis (e.g. if the railway company has no facilities, or if the services of a local analyst are not available), Alfloc Limited will examine the samples free of charge, though they should be informed beforehand in order to make the necessary arrangements.

By a careful examination of the data available for each water station, i.e. the composition of the water, the layout of the water system, the total quantity of water used and the frequency and quantity in which water is taken by locomotives, a decision can be taken as to the best type of treatment to use. A simple calculation will enable the cost of treatment to be obtained, including cost of chemicals, maintenance, obsolescence of plant, etc.

From a knowledge of the volume of water consumed and the temporary and permanent hardness obtained from the analysis of the water, the quantity of scale-forming salts entering the locomotive boilers per annum from each 'user' can be readily calculated. It is then possible by means of one of the accepted formulæ on page 15 to assess the gross saving possible if the scale and other trouble-forming salts are dealt with either by 'external' or by 'wayside' treatment. By comparing the total cost of treatment on any particular railway system with the gross estimated saving the railway company will then be able to calculate the net annual saving.

The technical service department of Alfloc Limited is available to assist companies who may be contemplating the adoption of water treatment, and with the help of the above information a complete scheme of treatment for each water station can be suggested.

In deciding the methods of treatment to be applied at any particular water station preference should be given to 'external' treatment where possible.

Experience has shown that:

- (a) 'External' treatment by the lime-soda-sodium aluminate process in general should be applied to those 'users' exceeding twelve to fifteen million gallons per year. For quantities below this figure the operating, maintenance and capital costs of the 'external' process render the 'wayside' method more economical. In addition to the volume of water treated a further deciding factor is the amount of temporary and permanent hardness it contains.
- (b) Waters with a total hardness of less than six degrees, e.g. soft waters of the moorland type, are more economically and efficiently treated, even in large volumes, by means of 'wayside' treatment. Moreover, owing to the fact that the removal of



Testing bench on a typical Lime-Soda plant (Sodium Aluminate dissolving tank on the left).

temporary hardness does not enter into the chemical cost of 'wayside' treatment, it may be more economic (where capital costs are a consideration) to treat large volumes of water of high temporary and low permanent hardness by the 'wayside' method, rather than by the 'external' method.

- (c) The cost of 'wayside' treatment rises in proportion to increasing permanent hardness and, in general, where the permanent hardness exceeds about six degrees, large volumes of water are more economically treated by the lime-soda process of 'external' softening.

## The Supervision of Water Treatment on a Railway

The success of any method of water treatment, provided it has been wisely chosen, depends essentially on careful supervision and chemical control of the operations involved. Where a railway company is equipped with a chemical department the services of this department can be utilized to full advantage. To meet the needs of companies who have no facilities of this nature Alfloc Limited have devised simple rapid tests and methods of control which are sufficiently accurate to ensure that the treatment is being properly applied.

These simple tests are available to all operators of the 'Alfloc' system of water treatment, and customers are familiarized with the suggested methods and systems of control before commencing the treatment. They should be carried out at regular intervals by those in charge of each plant, and results should be reported daily in the case of external plants to a central supervisor. 'Wayside' treatment plants require less attention, and the tests should be made and reported each time the plant is visited. Tests on samples of water taken from the boilers of the locomotives themselves are a useful guide as to the efficiency of the treatment.

Though frequent tests are necessary in the initial stages of a treatment programme, it is usually found that they can be reduced to a convenient minimum when steady working conditions are established.

Alfloc Limited will give any help or advice required by supervisors on receipt of copies of the necessary reports and information and, where possible, will lend personal assistance.

Space has not permitted more than a brief description of the processes available, but no effort will be spared by Alfloc Limited to help anyone interested; the purpose of the book is to arouse interest, not so much in technicalities but rather in the considerable economies which are now made available to all railway engineers by the adoption of the 'Alfloc' system of water treatment.

## BIBLIOGRAPHY

× *Water Treatment*, I.C.I. Booklet 4Ed/79/152/135. Deals in a concise manner with practically the whole field of water treatment and covers main types of natural waters, cause and effect of hardness and its quantitative estimation. Explains the chemical reactions and advantages of the Lime-Soda Process, describes advantages and use of sodium aluminate, and discusses water softening plant. Also includes 'Internal' treatment, treatment of acid, bicarbonate and polluted waters, oil removal and sterilization of water.

*The Control of Water Softening and Boiler Water Conditioning*, I.C.I. Booklet (3rd edition) R1/3 Ed./304/23/535, dealing with the analytical tests and methods required for the control of water softening and boiler water conditioning. The analysis of raw and softened water and of boiler blowdown is fully described and calculation of the quantities of reagents required for softening, etc., is set out. Details of the apparatus and the laboratory reagents necessary are given.

*Boiler Feed Water Conditioning*, I.C.I. Booklet (3rd edition) 3Ed./857/23/1235, dealing in a short and simple form with the principles and methods of boiler feed water conditioning ('internal' and 'external'), the control of conditioning, caustic embrittlement of boiler metal and the decomposition of sodium carbonate in boiler operation.

*Some Aspects of the Chemistry of Boiler Water*, I.C.I. Booklet No. 339/33/732. A reprint from the *Fuel Economy Review*, 1932, of a paper by H. E. Jones, dealing with the treatment of boiler feed water and the conditioning of boiler water. Scale prevention, caustic embrittlement and corrosion in low-pressure and high-pressure boiler plants are considered.

*The Use of 'Limbox' (Hydrated Lime) in Water Softening*, I.C.I. Pamphlet No. 3Ed./445/112/736, dealing with the composition of 'Limbox' hydrated lime and its use and advantages in water treatment.

× *'Alfloc' Sodium Aluminate in the Lime-Soda Process*, Alfloc Booklet BRI/327/23/637, giving a detailed account of the improvements and economies to be obtained by the use of sodium aluminate as a coagulant in the Lime-Soda process.

∧ *The Role of Sodium Aluminate in Water Softening*, I.C.I. Pamphlet No. 35/23/136, consisting of a Preface and reprints of articles in the *Journal of the Society of Chemical Industry* by L. M. Clark and L. S. Price, vol. lii, 1933, No. 6, pp. 35 T-44 T; L. M. Clark and P. Hamer, vol. liv, 1935, No. 4, pp. 25 T-28 T; and L. M. Clark and W. R. Cousins, vol. liv, 1935, No. 21, pp. 143 T-149 T, dealing with the chemistry of sodium aluminate in water-softening reactions and the results obtained in practice by its use.

*Alfloc Sodium Aluminate*, Alfloc Booklet 'A' 868/25/1235, which describes the composition of this I.C.I. chemical, its effects and advantages when used in water treatment generally, particularly in lime-soda water softening, feed water conditioning and coagulation.

*Water Softening in the Boiler by the Alfloc System*, Alfloc Booklet 399/53/736. Where the installation of a lime-soda softening plant is impracticable for financial or economic reasons, the 'Alfloc' System of Internal Softening often supplies an excellent alternative. This booklet describes the system and its methods of application in detail.

*A Scientific Boiler Water Treatment*, Alfloc Booklet 2Ed/340/23/637. The 'Alfloc' Briquette System for the 'internal' treatment of boiler water is fully discussed, both from the theoretical standpoint and with regard to the practical details of application.

*The Sterilization of Industrial Water*, I.C.I. Pamphlet No. 2Ed/399/13/734, dealing with the chlorination of industrial water supplies against fouling of condenser tubes, cooling towers and spray cooling plants and for the prevention of mussel fouling in power stations. The control of slime in paper mills and the treatment of effluents are also considered.

*Water Sterilization*, I.C.I. Booklet 3Ed/392/23/737, describes the sterilization of water by chlorination, super-chlorination and ammonia chlorination as applied to drinking water supplies, together with some industrial application of chlorine sterilization.

*Sodium Aluminate in Filter Plant Practice* (The Double Coagulation Process), Alfloc Booklet 2Ed/432/23/837. A new use for sodium aluminate is described, whereby in conjunction with the more usual coagulant, aluminium sulphate, marked economies and improvements may be secured in the clarification of municipal and other large water supplies.

## APPENDIX

### A description of the various Chemicals mentioned in this booklet

(These are recommended and supplied in accordance with the requirements of each individual case and available distribution facilities.)

#### *Sodium Carbonate* $\text{Na}_2\text{CO}_3$

Sodium Carbonate (Soda Ash) as supplied by Imperial Chemical Industries Limited is a white powder of high purity which is normally supplied in the bag packing, and is available in two qualities, light and heavy, either of which is suitable for water treatment purposes.

Sodium Carbonate is soluble in water, but care should be taken to add it to the water rather than vice versa.

#### *Caustic Soda* $\text{NaOH}$

Caustic Soda (Sodium Hydroxide) is supplied by Imperial Chemical Industries Limited, and is available either in the solid form or as flake or powder. All three varieties are of high quality and are equally efficient for water treatment purposes, but flake or powder are more easily handled, weighed out, and dissolved and are therefore often preferred where only small quantities are required.

Caustic Soda, and solutions of it other than very dilute ones, must be handled with care as they cause serious burns if they come into contact with the skin. Safety precautions include the use of goggles and rubber gloves.

#### *Lime*

Lime is supplied by Imperial Chemical Industries Limited and is available either as Lump Quicklime (calcium oxide), Ground Quicklime (calcium oxide), or as Hydrated Lime (calcium hydroxide).

The Quicklime has a calcium oxide content of approximately 98%. Ground Quicklime is in the form of a powder and has a calcium oxide content of approximately 95%. 'Limbox' Hydrated Lime has a calcium hydroxide content of approximately 96% and is a very fine white powder of very consistent composition and low silica content.

Caustic Soda, Quicklime, and Hydrated Lime are supplied to overseas customers in drums.

## *'Alfloc' Dry Powdered Sodium Aluminate*

### DESCRIPTION

This is a fine, divided, free-flowing, white powder of uniform composition; it contains approximately 42% soda ( $\text{Na}_2\text{O}$ ) and 52% aluminium oxide ( $\text{Al}_2\text{O}_3$ ). It is readily soluble in water, and being slightly hygroscopic should be kept in air-tight containers. When handling this material the customary precautions should be taken as this is a caustic material.

### PACKING

It is supplied in strong air-tight non-returnable steel drums.

### PROPERTIES OF SOLUTIONS OF 'ALFLOC' DRY POWDERED SODIUM ALUMINATE

Solutions of 'Alfloc' sodium aluminate of less than 2% strength are quite stable, but solutions of higher strengths must be stabilized in order to prevent the wasteful and troublesome deposition of crystalline alumina on feeding apparatus and pipe lines. It may be cheaper and more convenient in many cases of wayside treatment to purchase one of the 'Alfloc' stabilized sodium aluminate liquors described below.

## *'Alfloc' No. 4-R, Liquor*

### DESCRIPTION

This is a stabilized solution of sodium aluminate, caustic soda, and specially selected tannins, it contains the correct ratio of soda to alumina ( $\text{Na}_2\text{O}/\text{Al}_2\text{O}_3$ ) to provide full softening and coagulation properties in the one solution.

### CONVENIENT FOR ISOLATED POSITIONS

Although 'Alfloc' No. 4-R liquor is caustic it can be easily and safely transferred by means of a pump from tank wagons and drums to the chemical storage tank. Provided this tank is large enough, and reliable proportioning apparatus is used, the use of 'Alfloc' No. 4-R Liquor enables wayside treatment to be applied at places which can only be visited at infrequent intervals.

### AVOIDS TROUBLE OF MAKING UP SOLUTION

Its use avoids the danger of making up solutions of the wrong chemicals or of incorrect strength which may occur when only non-technical labour is available.

### SPECIALLY SUITED FOR CERTAIN TYPES OF WATER

Since the quantity of 'Alfloc' 4-R Liquor used should be proportional to the quantity of permanent hardness present, plus a slight excess to give the requisite alkalinity, the use of 'Alfloc' No. 4-R Liquor is specially economical with the softer waters and waters relatively low in permanent hardness.

### PACKING

In the British Isles this liquor is supplied in strong steel returnable drums; it can also be supplied in tank wagons.

Should any railway company abroad require to use the liquor the most economical way of supplying it will be investigated.

## *'Alfloc' No. 3-R Liquor*

### DESCRIPTION

This stabilized solution of sodium aluminate, caustic soda and tannins, contains over four times the available alumina of the 'Alfloc' No. 4-R Liquor. This enables it to be used in conjunction with separate alkali solutions (made up on site), thereby keeping the amount of soda ( $\text{Na}_2\text{O}$ ) and Alumina ( $\text{Al}_2\text{O}_3$ ) applied to the water in the same correct ratio as if only 'Alfloc' No. 4-R Liquor were used.

### CONSIDERATIONS OF ITS USE

Since the cost of treating a water with 'Alfloc' 4-R Liquor is proportional to the permanent hardness, it may be cheaper to use the 'Alfloc' No. 3-R Liquor containing more sodium aluminate, with additional alkali solution made up on site, provided that the cost of labour in making up the separate alkali solution is less than the cost of using more 'Alfloc' No. 4-R Liquor (see note on making up solution under 'Alfloc' No. 4-R Liquor above).

## *'Alfloc' Briquettes*

'Alfloc' briquettes form a very convenient and safe form of applying a mixture of suitable chemicals in cases where, although labour is available, it is thought undesirable for solutions to be made up on site.

They are prepared according to various formulæ, the combination of chemicals selected being dependent upon the analysis of the water to be treated. The briquettes, each of which weighs approximately one pound, are manufactured in ball form in such a manner that they dissolve at a uniform rate in 'Alfloc' By-pass Feeders if a reasonably uniform rate of flow of water is maintained.

### *'Alfloc' No. 42-ABB Briquettes*

These contain the correct quantity of suitable alkalies, together with the requisite amount of sodium aluminate and tannins for use in the 'Alfloc' System of Wayside Treatment; one form is suitable for the 'partial precipitation method of wayside treatment', whilst another form, containing a suitable inhibitor, is intended for use in the 'deferred reaction method of wayside treatment'. The 42-ABB briquettes are used for the prevention of scale and corrosion with the majority of waters and can be modified to suit particular conditions.

#### ADVANTAGES

'Alfloc' Briquettes are specially suitable for use in places where it is not desirable to handle and weigh individual chemicals and for waters of less than 10 degrees (English) permanent hardness; their economic use with waters above 10 degrees permanent hardness is determined by comparing the practical value of the above advantages with the cost of alternative methods of treatment.

### *'Alfloc' No. 11 Briquettes*

These contain sodium phosphate and suitable inhibitors, and have been found particularly useful in the treatment of waters low in hardness and high in silica.

### *'Calgon'*

Sodium hexmetaphosphate ('Calgon') contains nearly 70% of  $P_2O_5^*$  and at ordinary temperature forms a soluble complex compound with calcium salts which is fairly stable below  $212^\circ F$ . Consequently, when 'Calgon' is used, the troubles due to deposits of calcium compounds in feed lines, injectors, etc., are minimized. Above  $212^\circ F$ . (i.e., in the boiler) the complex compound is rapidly decomposed and ordinary calcium phosphate is precipitated as a sludge. (Should this sludge tend to bake on heating surfaces 'Alfloc' No. 28 powder should be used instead—see below.) 'Calgon' can be supplied either as flakes or as an ingredient of 'Alfloc' No. 28 Powder.

### *'Alfloc' No. 28 Powder*

This formula is made by carefully blending a high percentage of 'Calgon' with a suitable quantity of reactive tannins. The tannins absorb oxygen and

\*  $P_2O_5$  is known to chemists as phosphorus pentoxide and all phosphates are compared on the basis of the quantity of  $P_2O_5$  which they contain.

thereby minimize corrosion. They also inhibit feed line deposits and prevent the calcium phosphate sludge from adhering as boiler scale. The use of 'Alfloc' No. 28 powder is strongly recommended with soft waters containing a high proportion of silica and for the conditioning of feed-water for use in high-pressure boilers where the percentage of make-up is small.

#### SPECIAL MIXTURES FOR 'DEFERRED REACTION' METHOD OF 'WAYSIDE' TREATMENT

Special powders which can be dissolved in water on site will be made up to suit particular conditions; they contain the requisite quantities of alkali and sodium aluminate for softening, and of inhibitors for preventing chemical reaction until the water reaches the boiler.

### *'Alfloc' No. 58 Formula (Briquettes and Powder)*

This is a combination of a high proportion of carefully selected tannins with the correct ratio of  $P_2O_5$  in the form of suitable phosphate. It can be supplied either in powder or briquette form, the choice of which depends upon local conditions.

### *'Alfloc' Antifoam*

A highly dispersed emulsion of tannins and castor oil, stabilised with other reagents. It is recommended for the prevention of priming and foaming in cases where highly saline or other abnormal feed waters have to be used.

### **Apparatus required for Wayside Methods of Treatment**

It is essential to control the quantities of chemicals added to the raw water within reasonable limits of accuracy. If insufficient quantities are added corrosion and scale formation will still occur, while an excess leads to wastage of chemicals, increased alkalinity and an increase in the dissolved solids in the boiler to a point where priming may occur. It is just as important to use efficient proportioning gear with wayside treatment as it is in external softening by the lime-soda process.

## Choice of Suitable Apparatus

The chemicals employed in the 'Alfloc' method of Wayside Treatment can be fed by two distinct methods, namely:

- (a) In liquid form;
- (b) In ball briquette form.

A number of considerations are involved in the choice of the method of feeding; having decided this, the particular apparatus required must then be determined. The relative advantages of the various methods are described in the following sections, and Alfloc Limited can give the necessary advice to assist railway companies in arriving at the correct decisions.

## Apparatus for Feeding Solutions and Solids

Whilst accurate proportioning apparatus for either method (a) or (b) may be obtained from most of the leading manufacturers of water softening plants at home and abroad, a description of apparatus for the liquid and solid methods of feeding is given here of types which have proved successful in practice.

This equipment was originally designed and perfected for use in 'wayside treatment' by the National Aluminate Corporation of Chicago—an associated company of Alfloc Limited; it has been extensively used in America and is operating successfully in many parts of the world. Alfloc Limited will supply plant manufacturers or railway companies with full working drawings and other data of this equipment to enable them to develop and manufacture it, if they so desire.

### (a) Apparatus for Liquid Feed

Liquid feed includes the application of 'Alfloc' liquors and also solutions of those chemicals which are made up on site before use. Frequently a proportioning pump is used for liquid feed, and provided this is well made and properly designed it will give excellent service for long periods without attention.

Various arrangements whereby the amount of solution delivered by the pump is kept proportional to the quantity of water treated are described later; assuming that the method chosen is reasonably accurate then the method of applying the chemicals in the form of liquors or solution is very satisfactory whether the flow of water is continuous or intermittent.

Other methods of feeding solutions, for example, by displacement, may be successfully used provided a given quantity of solution is always fed for a given quantity of water treated.

The National Aluminate Corporation found that the most reliable and simple method of feeding solutions in railway practice was by means of a suitably designed ram pump, known as the 'Nalco' Chemical Proportioner.

## The 'Nalco' Chemical Proportioner

The 'Nalco' chemical proportioner is essentially a ram pump and is available in various types which will satisfy all normal operating conditions. It is supplied either for direct connection to and operation from the main water pumps, for electric motor drive, or for drive by the 'Nalco' water motor (q.v.). (The chemical proportioner is available with plunger diameters of  $\frac{1}{2}$ ",  $\frac{3}{4}$ ", 1",  $1\frac{1}{4}$ ", and  $1\frac{1}{2}$ ".) All types are of adjustable stroke 0"—2", except type AR, which is adjustable 0"—1". The plungers are graduated and the setting may readily be altered by means of a knurled nut which is provided with a locking device. Volumetric efficiencies of 90 per cent are secured regularly, and no trouble is experienced due to 'air locking' on short pump strokes. They are manufactured from metals capable of resisting chemical attack. The pumping capacities of 'Nalco' proportioners at various rates are shown on the accompanying diagrams. (See page 66.)

The 'Nalco' Chemical Proportioner is supplied in a number of forms which can be driven in any of the following ways:

- (a) AS Proportioner driven by 'Nalco' water motor.
- (b) AS Proportioner driven by sprocket and chain connection to the water-pumping equipment.
- (c) AM Proportioner driven by electric motor.
- (d) ADM Proportioner (for feeding two solutions) driven by electric motor.
- (e) AR Proportioner driven by direct coupling to the reciprocating part of an engine or pump.
- (f) AW Proportioner driven by suitable water pressure.
- (g) AGB Proportioner driven by high-speed revolving shaft.

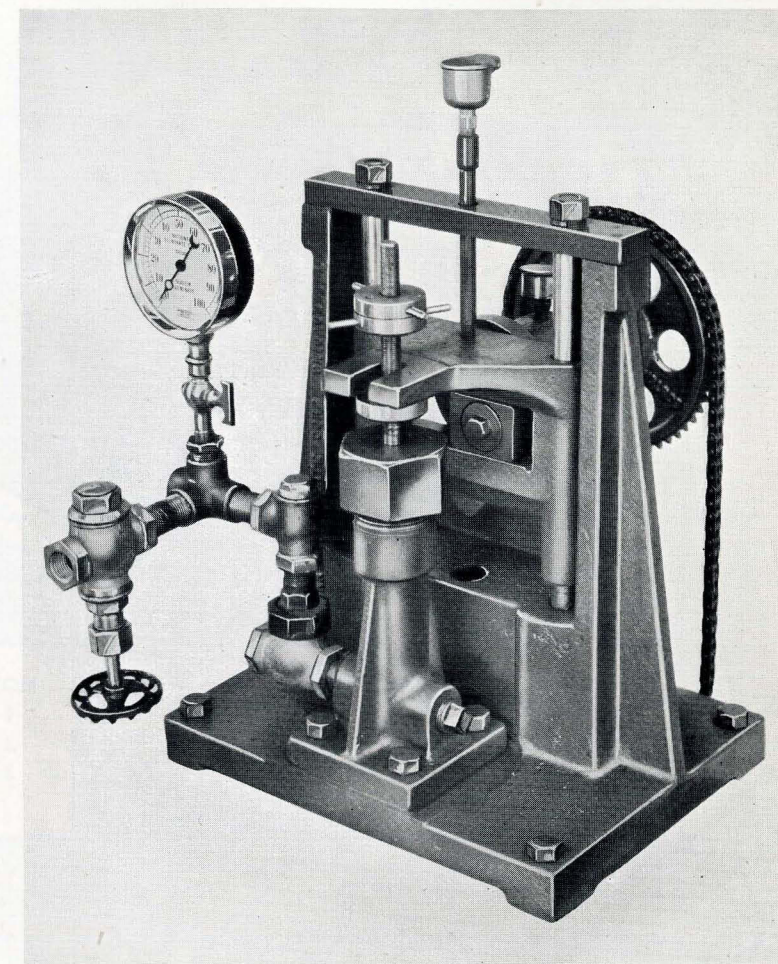

Fig. 1. Type AS Chemical Proportioner



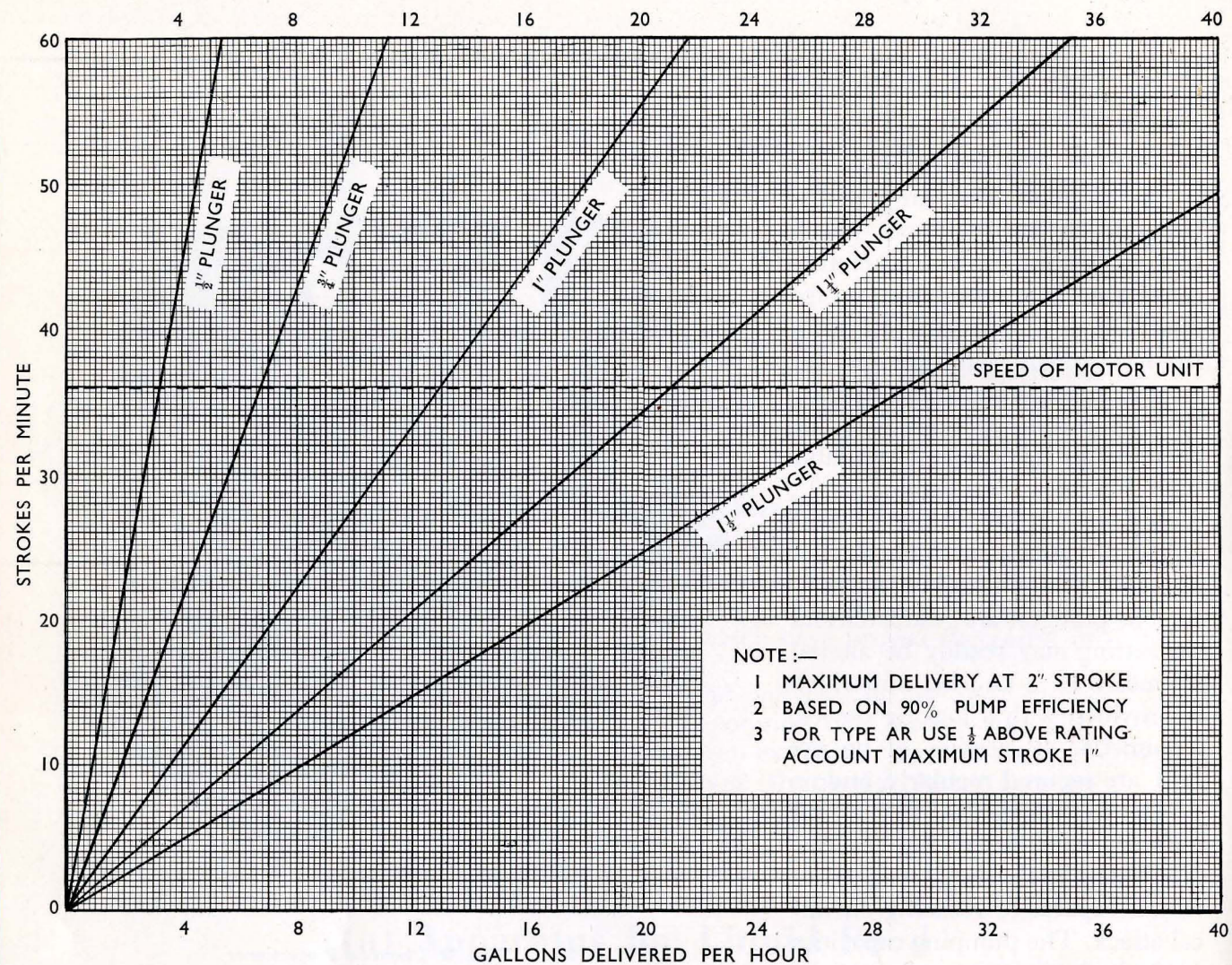

Fig. 2. Capacity Chart for 'Nalco' Chemical Proportioners

### Various types of 'Nalco' Proportioners

#### (a) AND (b) AS 'NALCO' CHEMICAL PROPORTIONER

This type (see photograph, page 65) is designed to be driven from a revolving shaft through sprocket and chain connection, and is especially adapted for use with the 'Nalco' water motor, or for connection to the intermediate jackshaft of pumping equipment. It is supplied complete with drive and driven sprockets (in ratio combinations of 19, 38, 57, and 76 teeth), right and left hand mounting studs for drive sprockets, six feet of chain, and with check valve assembly and pressure gauge.

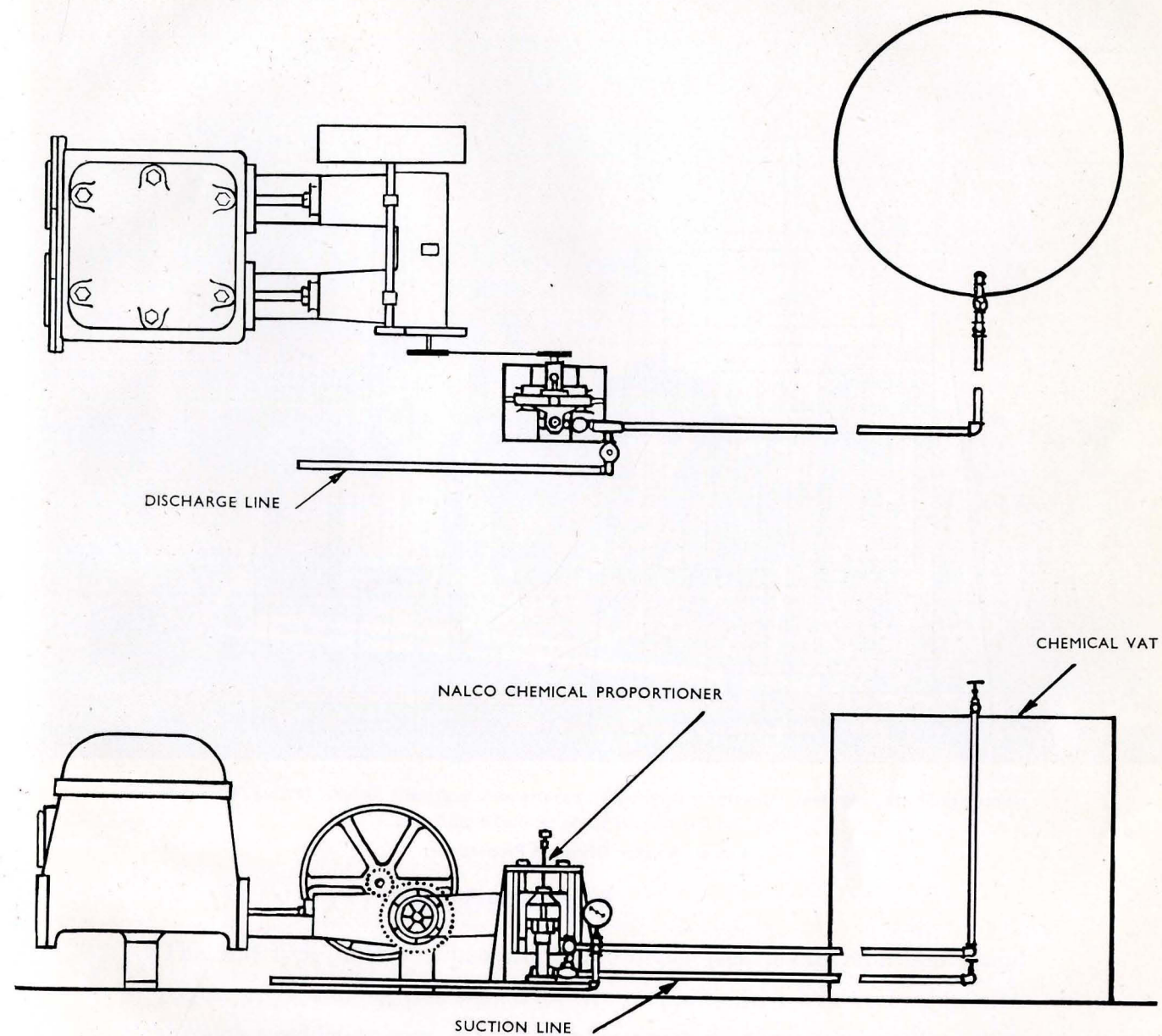

Fig. 3. Typical installation type AS Chemical Proportioner, operated by belt drive

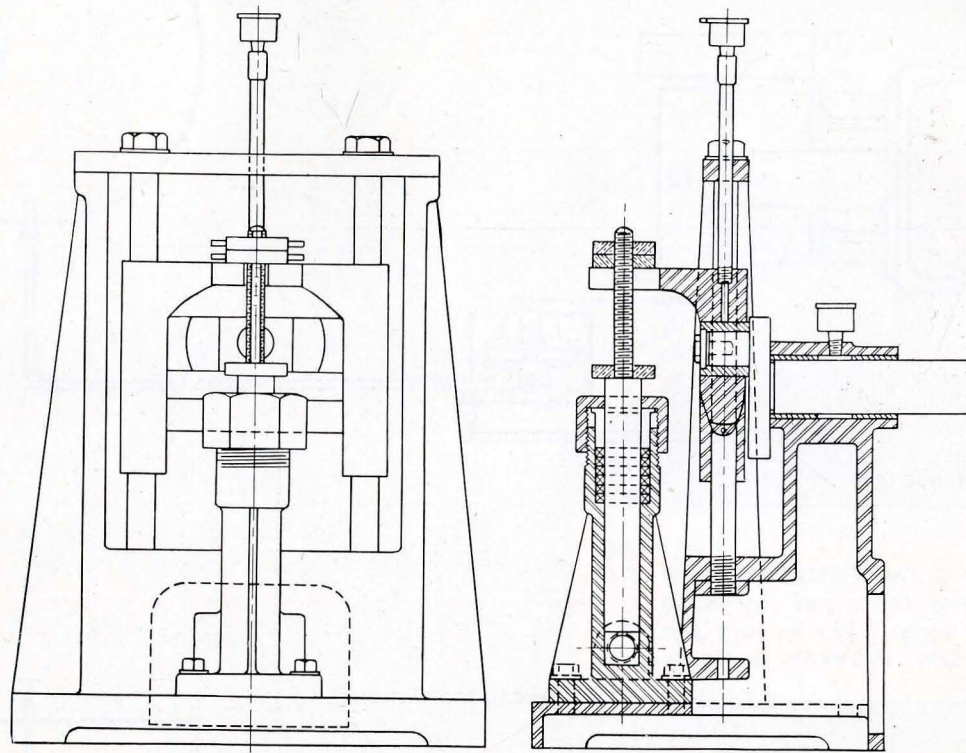

Fig. 4. AS type Chemical Proportioner

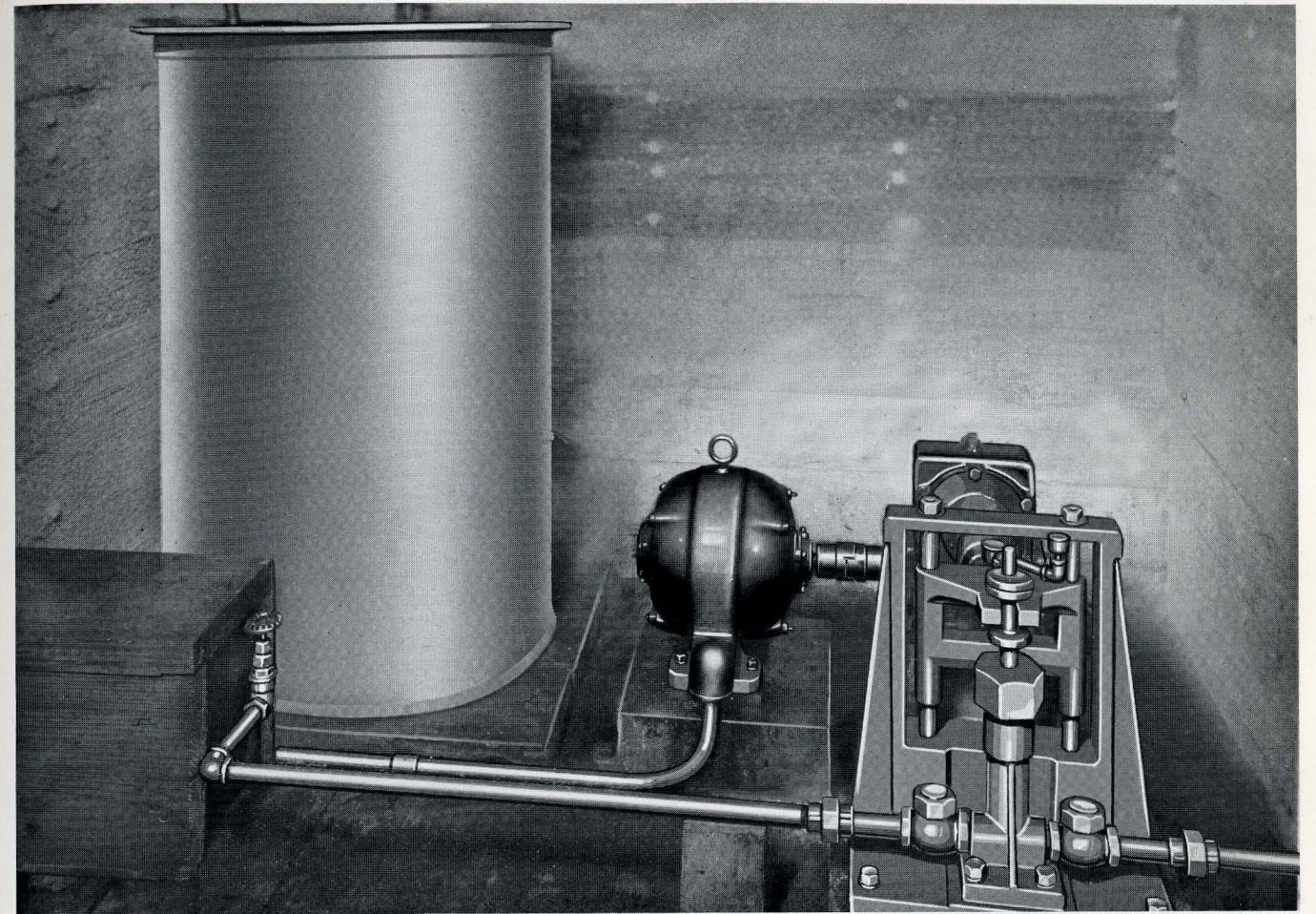

Fig. 5. Type AM 'Nalco' Chemical Proportioner. Operation is pressure controlled, the Proportioner operating whenever water is delivered into tank

(c) AM 'NALCO' PROPORTIONER

The AM type 'Nalco' Chemical Proportioner (see photograph above and pages 70, 71, and 74) is designed for electric motor drive by direct connection through a reduction gear. It is supplied complete with ball bearing 1800 r.p.m. motor ( $\frac{1}{2}$  h.p. for sizes up to and including 1" plunger; 1 h.p. over 1"), check valve assembly and pressure gauge, and with magnetic switch for overload and undervoltage protection.

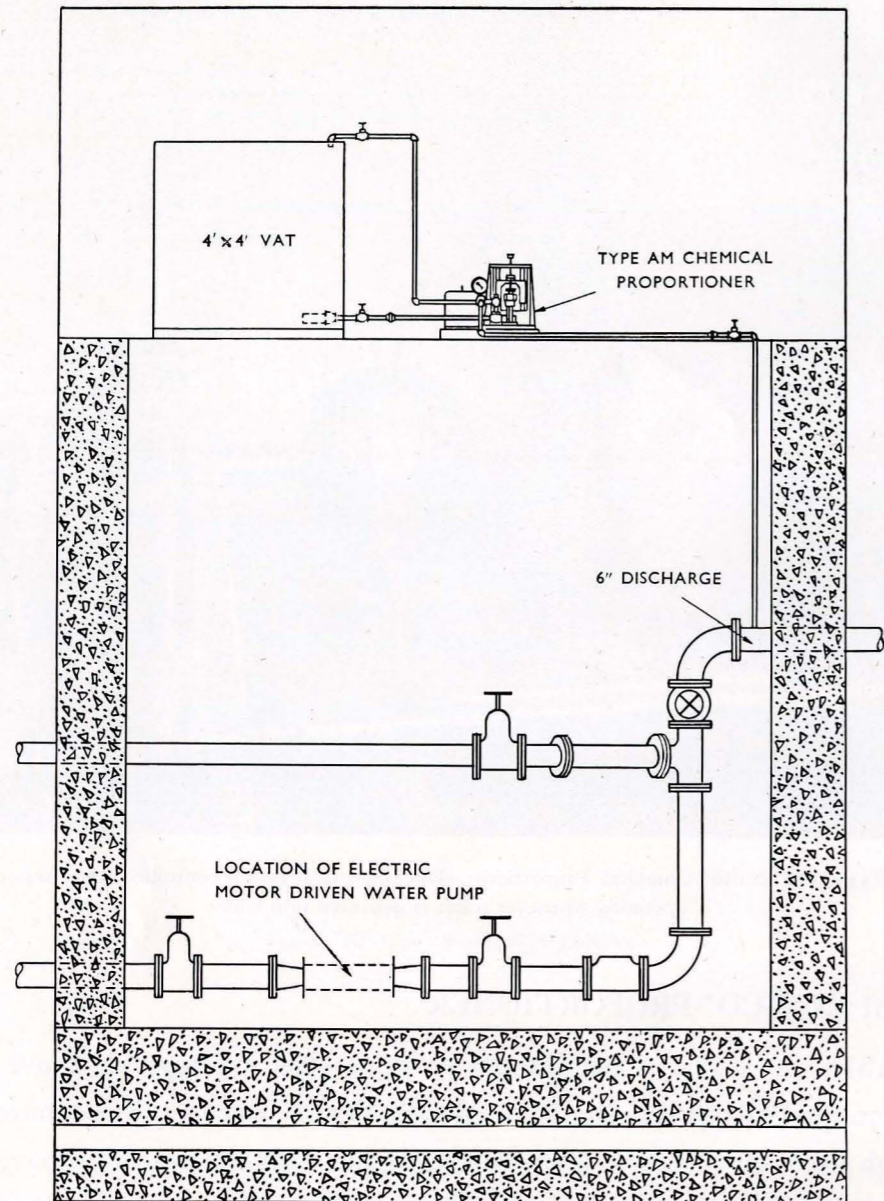

Fig. 6. Typical layout of type AM 'Nalco' Chemical Proportioner

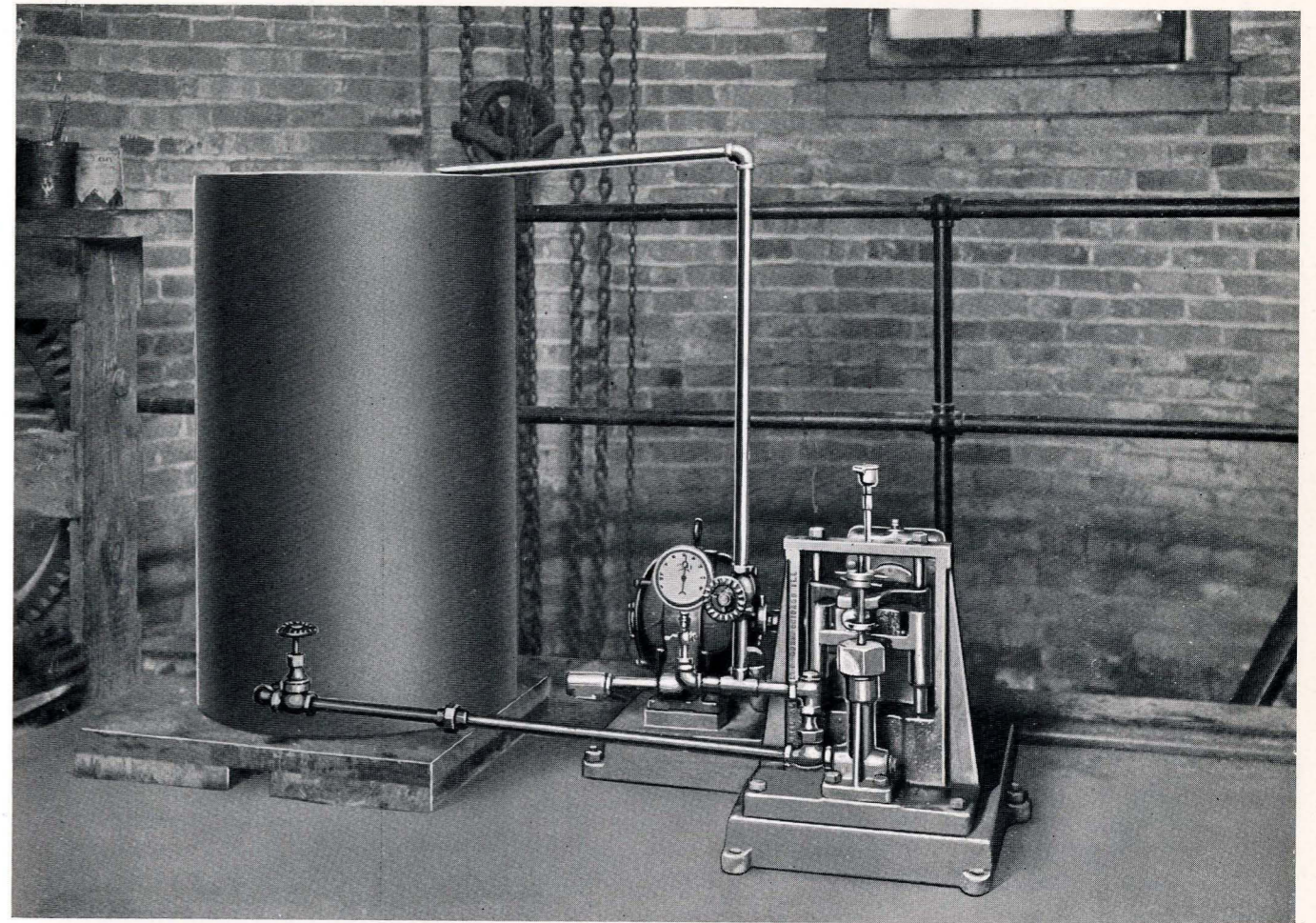
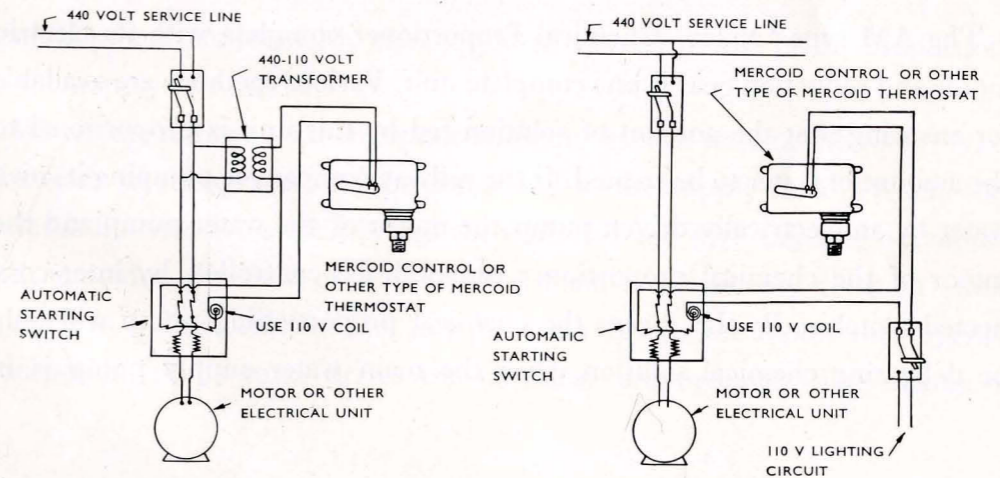

Fig. 7. Type AM 'Nalco' Chemical Proportioner installed in pump house. Motor-driven water pump is used, and the proportioner is connected to automatic switch controlling water pump



WIRING DIAGRAM FOR 440 VOLT CURRENT USING TRANSFORMER

WIRING DIAGRAM FOR 440 VOLT CURRENT USING 110 VOLT LIGHTING CURRENT

Fig. 8. Typical wiring diagram for 'Mercoid' controlled type AM 'Nalco' Chemical Proportioner

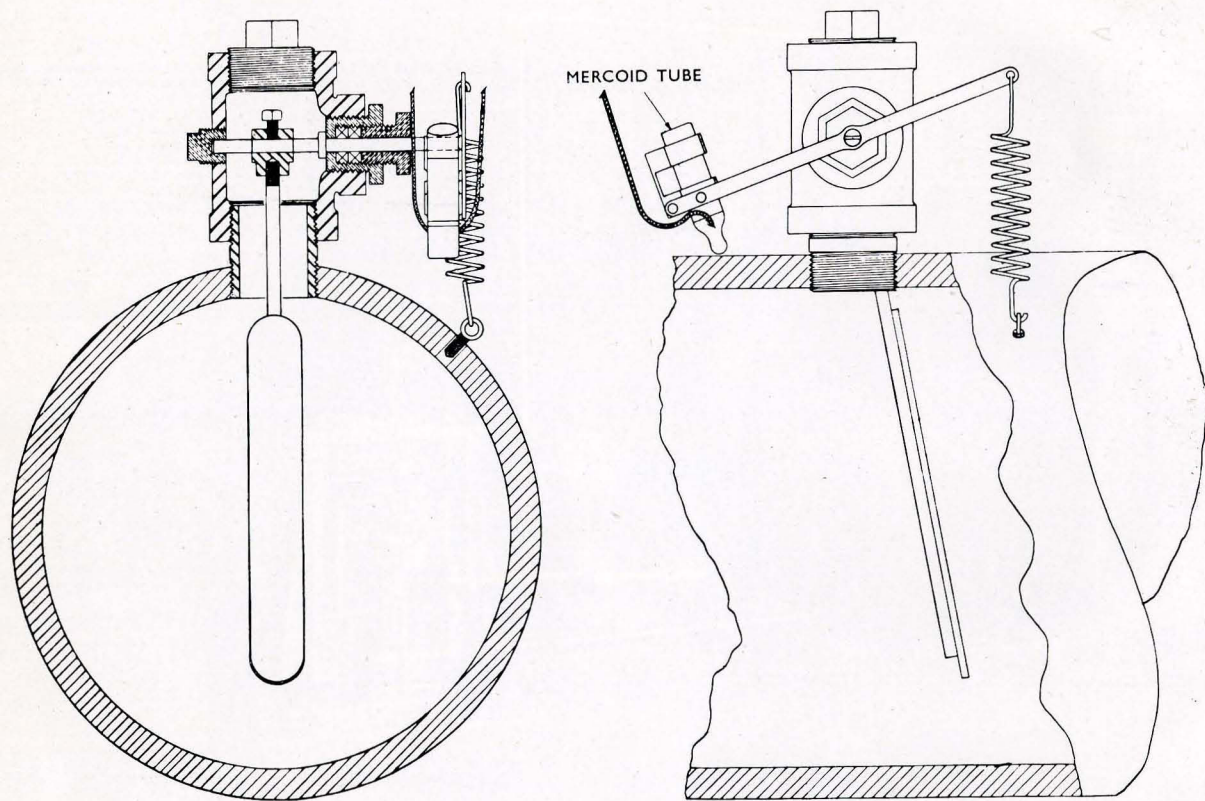

Fig. 9. Pressure operated 'Mercoïd' switch fitted to pipe line

The AM type 'Nalco' Chemical Proportioner complete with its electric motor and reduction gear is one complete unit. Various methods are available for ensuring that the amount of solution fed by this unit is proportional to the amount of water to be treated. If the railway company is pumping its own water by an electrically driven pump the motor of the water pump and the motor of the chemical proportioner can both be controlled by inter-connected switches. By this means the chemical proportioning pump will only be delivering chemical solution when the main water supply pump is in

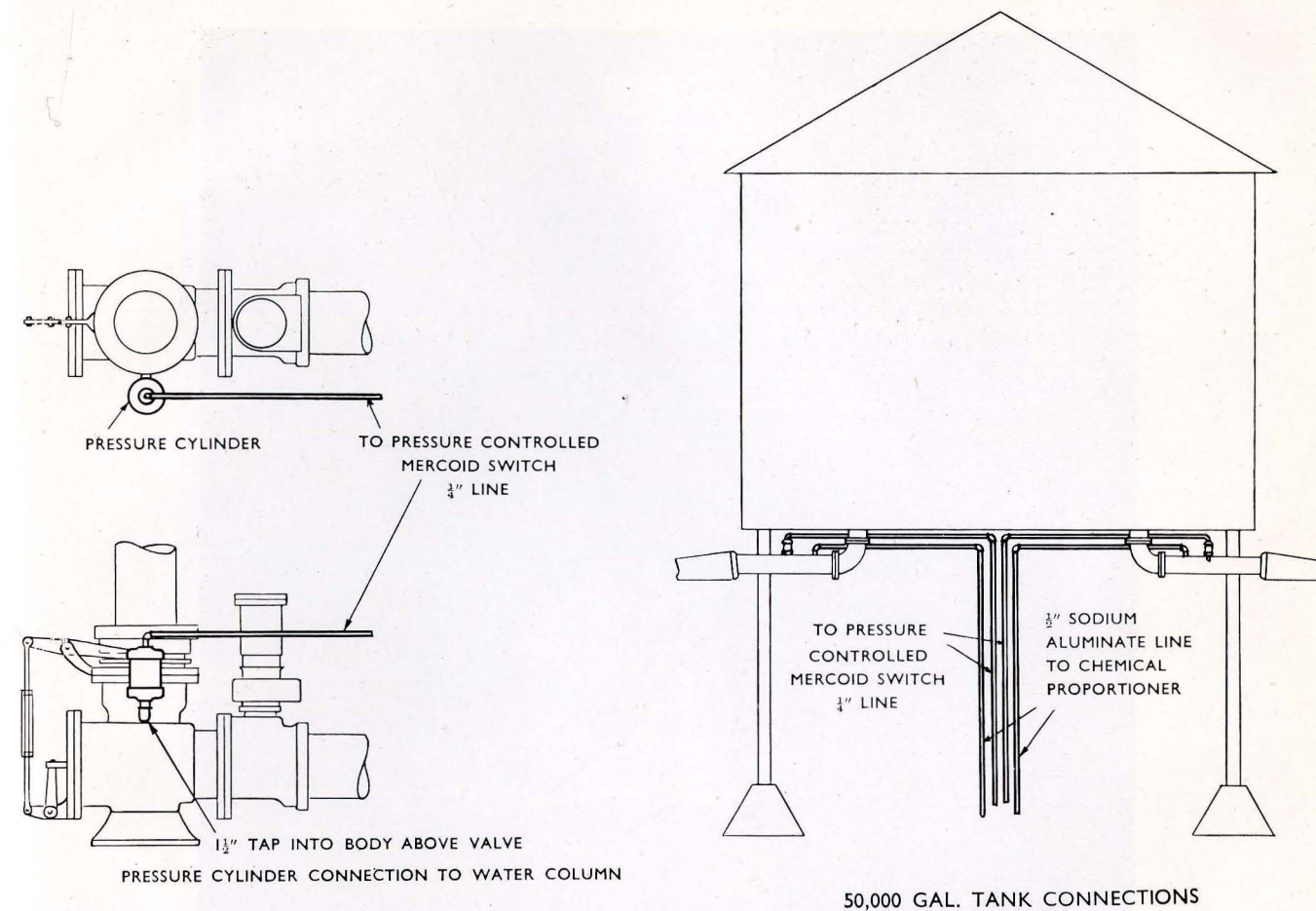

Fig. 10. Typical arrangement of pressure lines to 'Mercoïd' controlled type AM 'Nalco' Chemical Proportioner

operation, and consequently the supply of chemical will be in proportion to the supply of water.

Where the railway company is not pumping its own water a 'Mercoïd' type of switch (see diagrams) can be connected to the supply main. When the water is flowing this switch brings the motor of the AM unit into operation and, provided the flow of water in the main is reasonably constant, this method is quite accurate. The flow of water brings the motor into operation which, in its turn, drives the chemical proportioner. The chemical

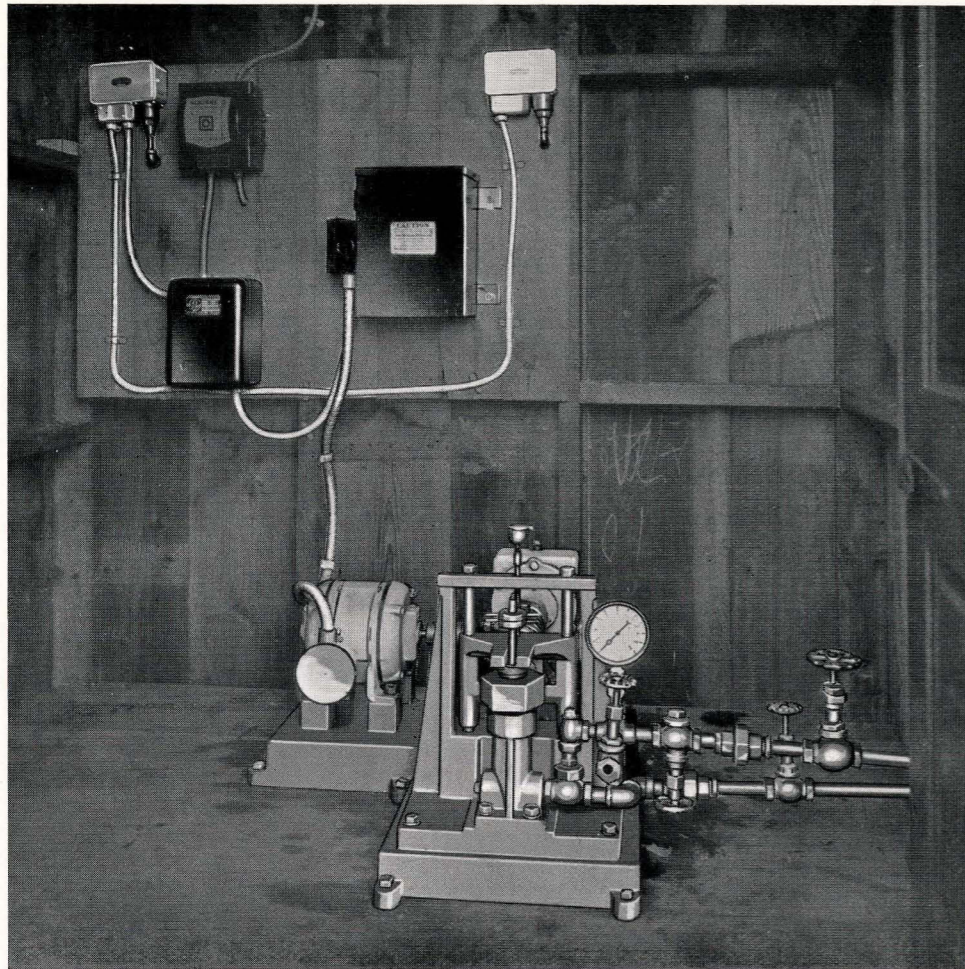

Fig. 11. Type AM 'Nalco' Chemical Proportioner controlled by pressure-operated 'Mercoïd' switches, the controls being situated in outlets of water supply tank overhead

proportioning pump is therefore in operation whenever water is flowing in the main. This system is of special value where there are several draw-offs from a storage tank.

Where the level in the water tank is controlled by a float-operated electric switch it is possible to synchronize the starting and stopping of the motor of the AM unit with the motor of the main water-feed pump. Other methods of synchronizing the motors of the AM unit with the water supply system may suggest themselves to those in charge of water treatment plants.

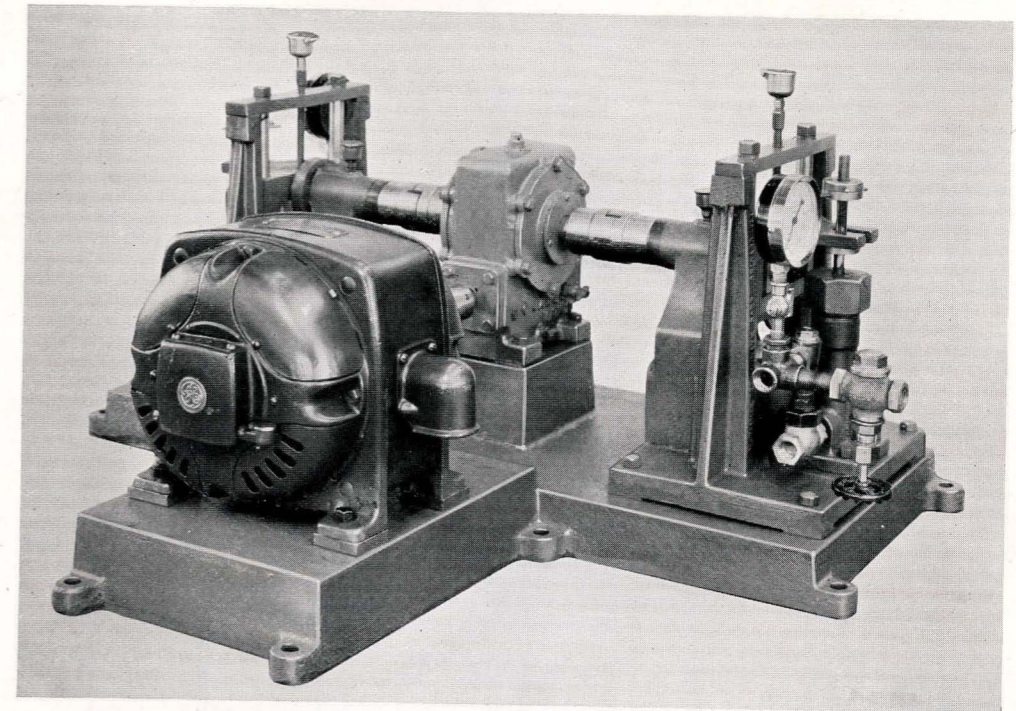

Fig. 12. Type ADM 'Nalco' Chemical Proportioner

#### (d) ADM 'NALCO' CHEMICAL PROPORTIONER

The ADM type 'Nalco' Chemical Proportioner (see photograph above) is similar to type AM, except that two pumping units are arranged to be driven from the motor through a reduction gear. It is especially adapted for use where two chemical reagents are to be used. A pump body of special alloy may be supplied of handling special liquids.

The same methods of synchronizing the output of this unit with the quantity of water to be treated can be adopted as those described for the AM proportioner.

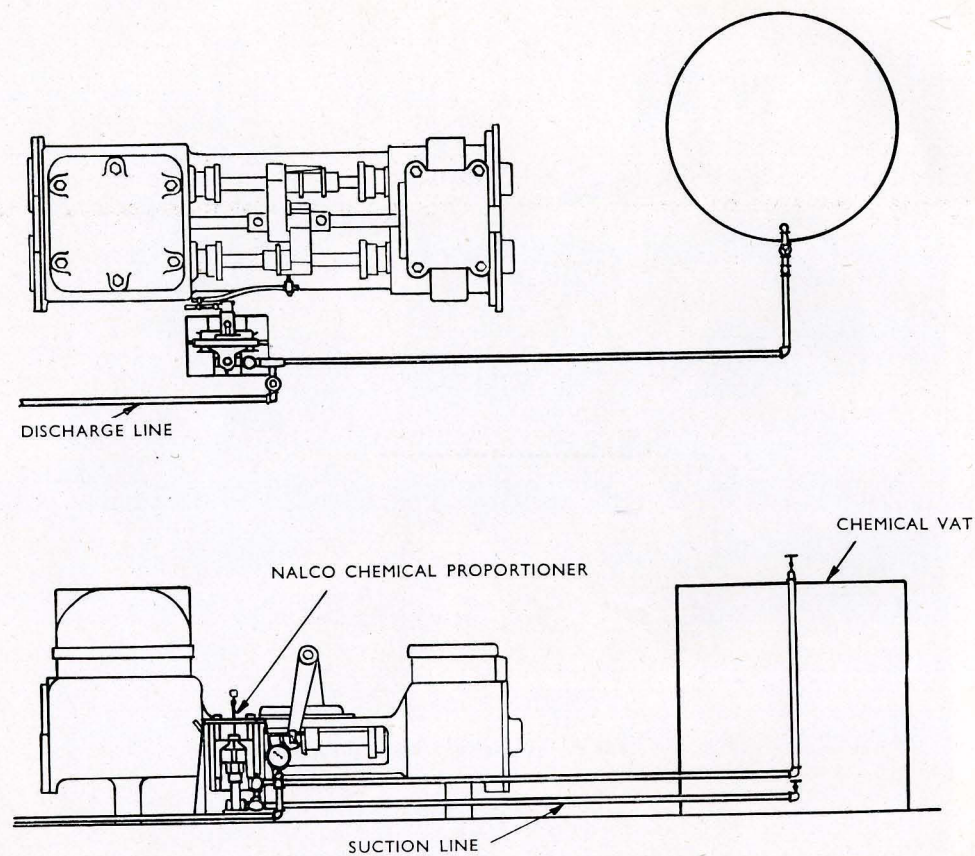

Fig. 13. Typical installation of type AR Chemical Proportioner

(e) AR 'NALCO' CHEMICAL PROPORTIONER

The AR type 'Nalco' Chemical Proportioner is designed for direct connection to a reciprocating part of the pump or engine, and is especially adapted for use with horizontal or vertical reciprocating pumps. It is supplied complete with driving and connecting knuckles, drive rod, and with check valve assembly and pressure gauge.

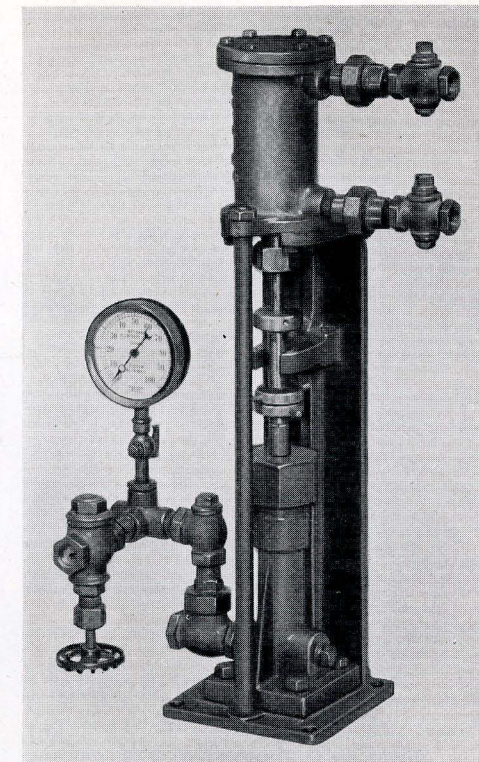

Fig. 14. Type AW Chemical Proportioner

(f) AW 'NALCO' CHEMICAL PROPORTIONER

The AW type 'Nalco' Chemical Proportioner (see photograph above) has been developed for installations where the type AR cannot be used. On some reciprocating pumps the valve gear is enclosed, and there are no external reciprocating parts to which the driving equipment of the AR type can be connected.

The AW type utilizes water pressure for its operation. The  $\frac{1}{2}$ " pipe connections on the upper or power cylinder ( $2\frac{1}{2}$ " inside diameter) are led one to each end of the water cylinder of the water pump. The power or pressure impulse of each stroke of the water pump is thus transmitted to the piston of the small water cylinder on the proportioner, which in turn operates the plunger of the chemical pump in synchronism with the water pump, automatically proportioning the delivery of the liquor. The AW type proportioner is supplied complete with regulating cocks, unions, check valve assembly and pressure gauge.

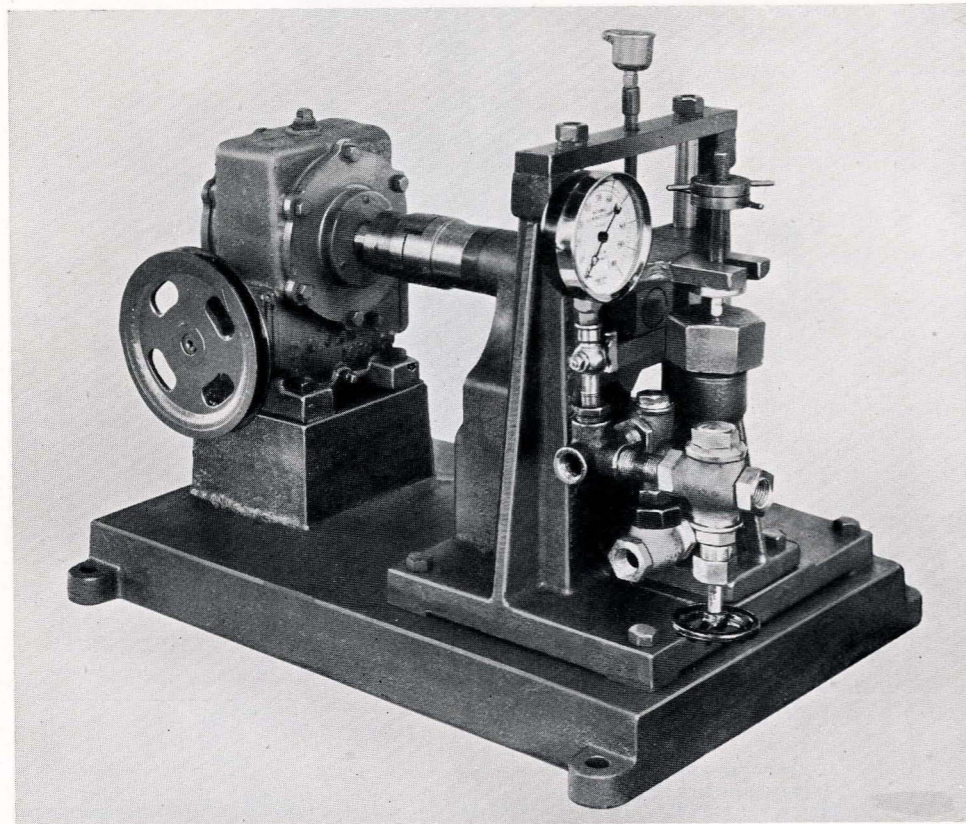

Fig. 15. 'The AGB type Chemical Proportioner

(g) AGB 'NALCO' CHEMICAL PROPORTIONER

The AGB type 'Nalco' Chemical Proportioner (see photograph above, and page 79) is designed to be driven from a high-speed revolving shaft through pulley and belt connection and gear reducer, and is adapted for use with high-speed motors, engines and centrifugal pumps. It is supplied complete with drive and driven pulleys, in various ratio combinations, right and left hand mounting studs, 10 feet of belt, and with check valve assembly and pressure gauge.

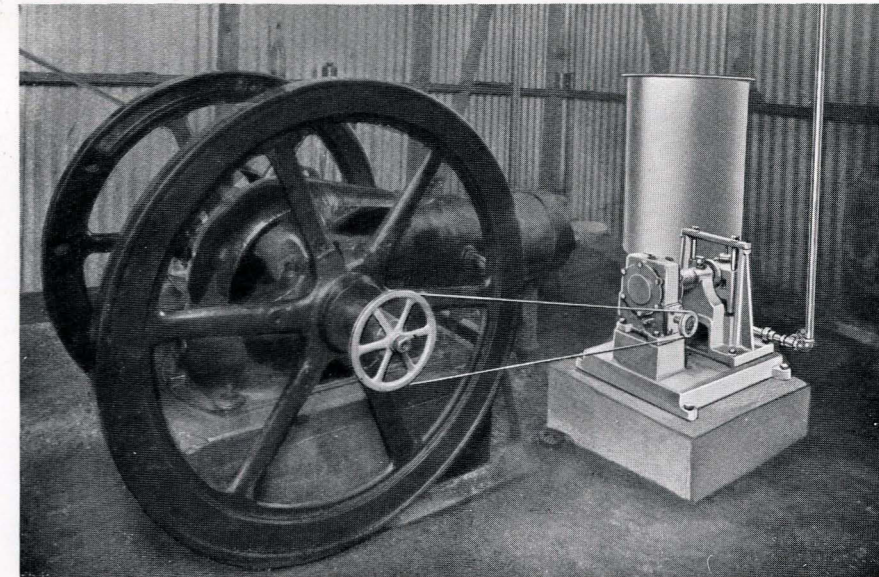

Fig. 16. Type AGB Chemical Proportioner connected to and driven by oil engine

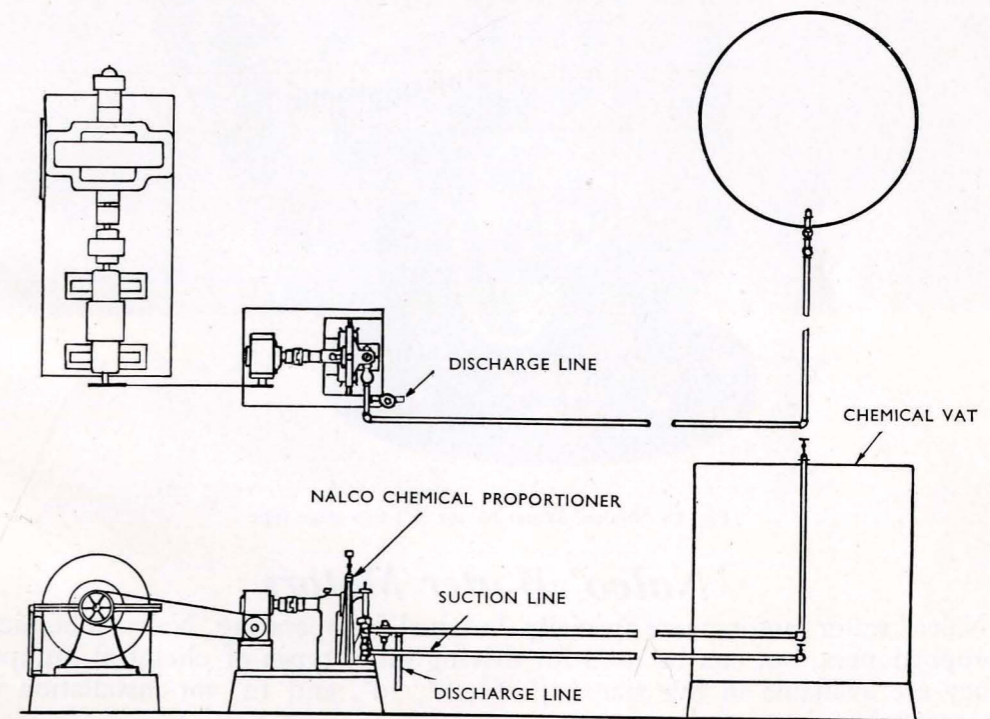

Fig. 17. Typical installation of type AGB 'Nalco' Chemical Proportioner

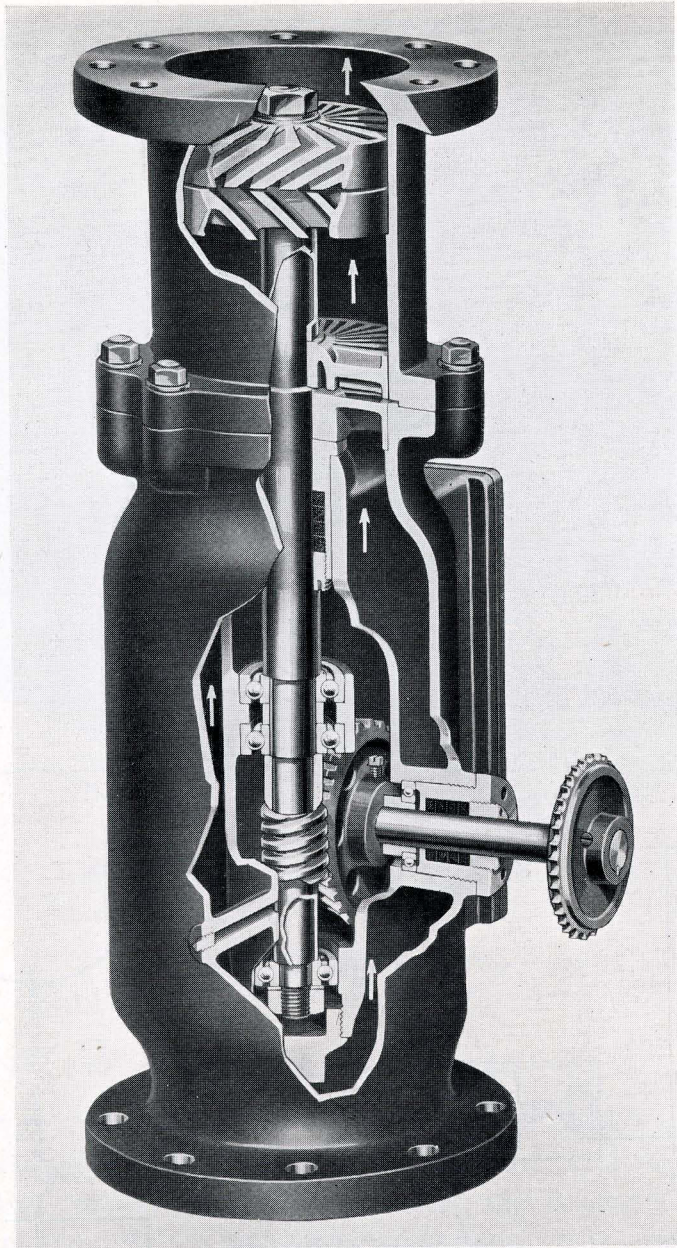

Fig. 18. 'Nalco' Water Motor (6") two stage type

### *'Nalco' Water Motors*

'Nalco' water motors were specially designed for operating 'Nalco' chemical proportioners, but can be used for driving other types of chemical pumps; they are available in five sizes: 4", 6", 8", 10", and 12" for installation in water mains.

The passage of the water through the motor causes it to rotate in proportion to the volume of water passing (see graph), and this in turn operates the chemical proportioner (vide type AS proportioner photograph, page 81). Thus the amount of 'Alfloc' liquor added is in proportion to the volume of water flowing.

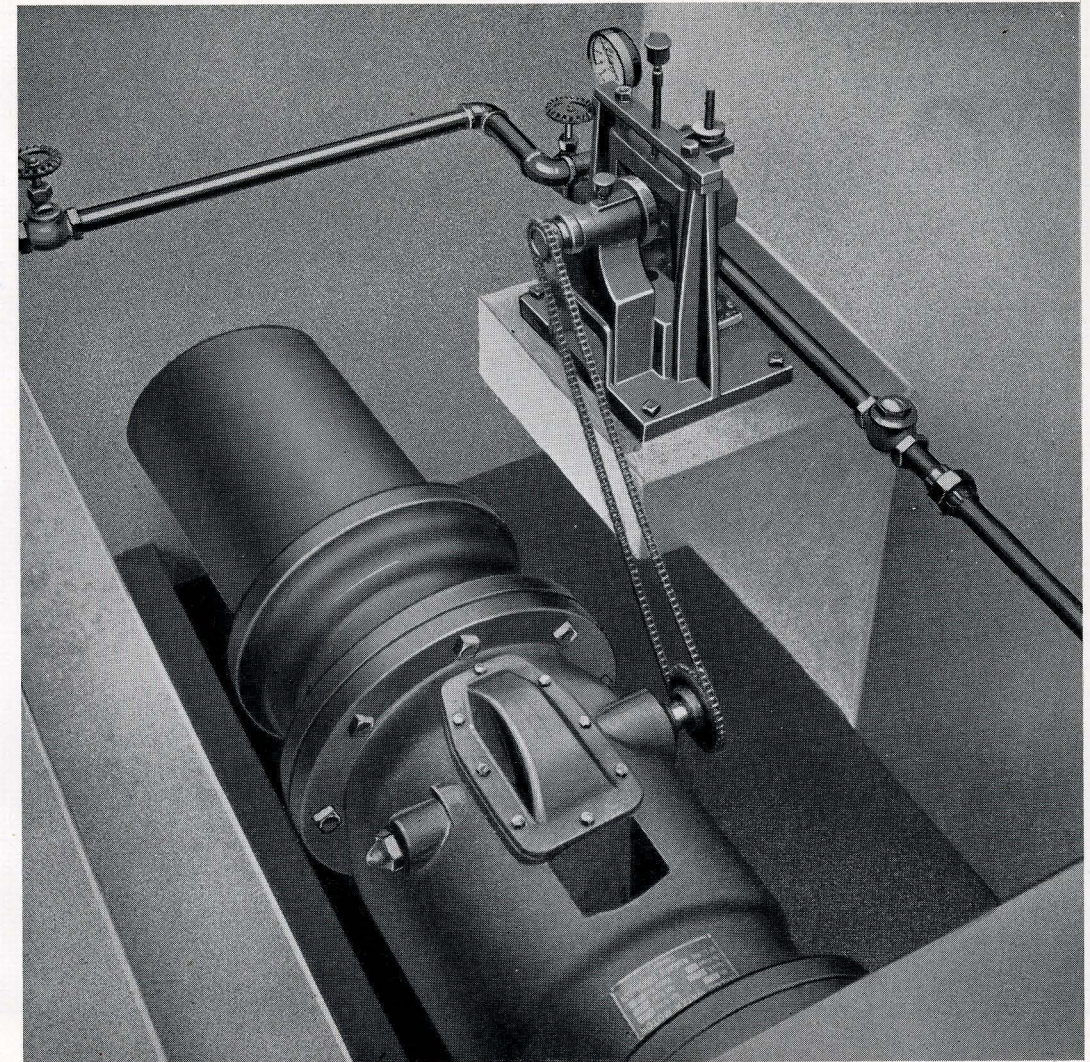

Fig. 19. 'Nalco' (12") water motor and AS type Chemical Proportioner



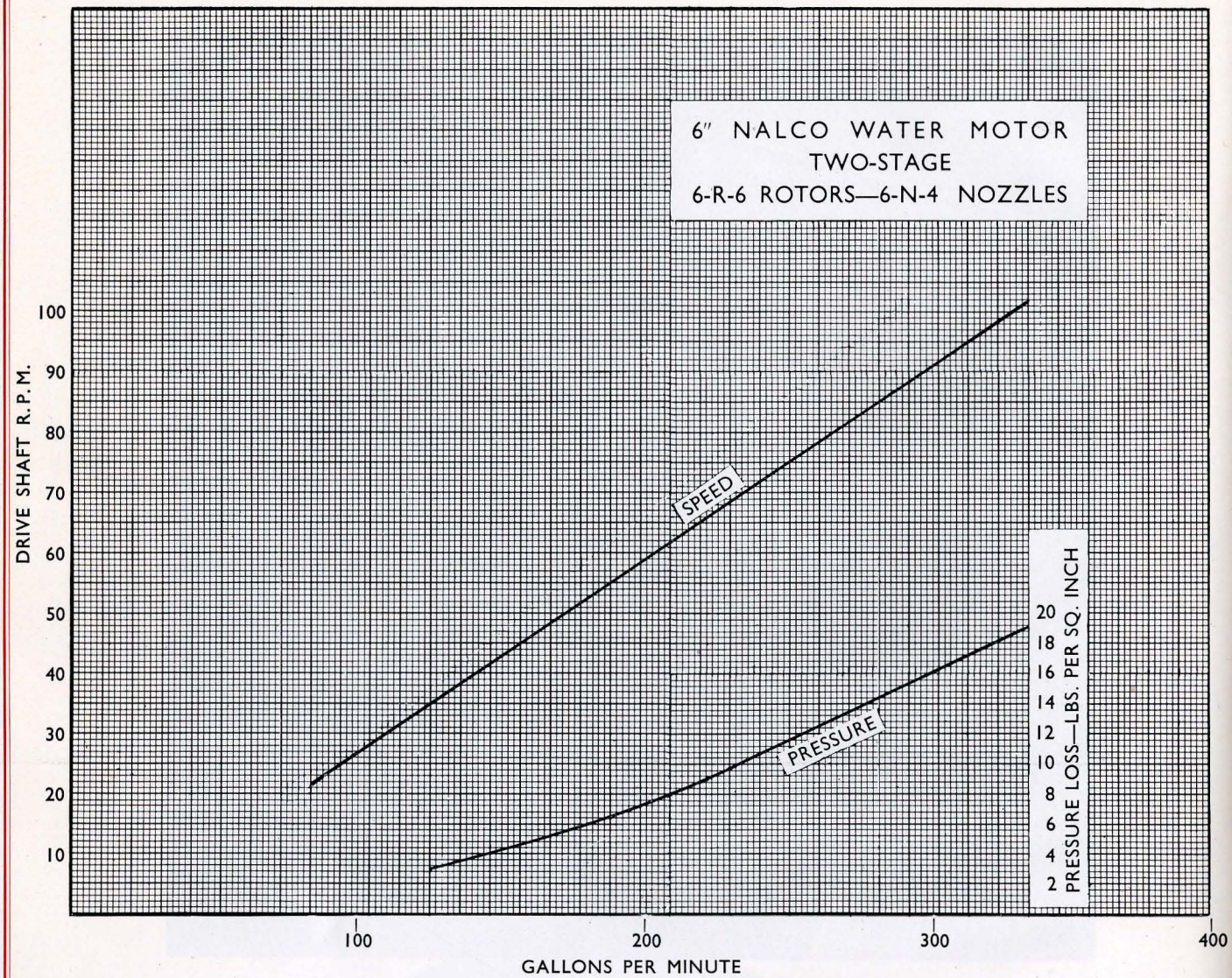
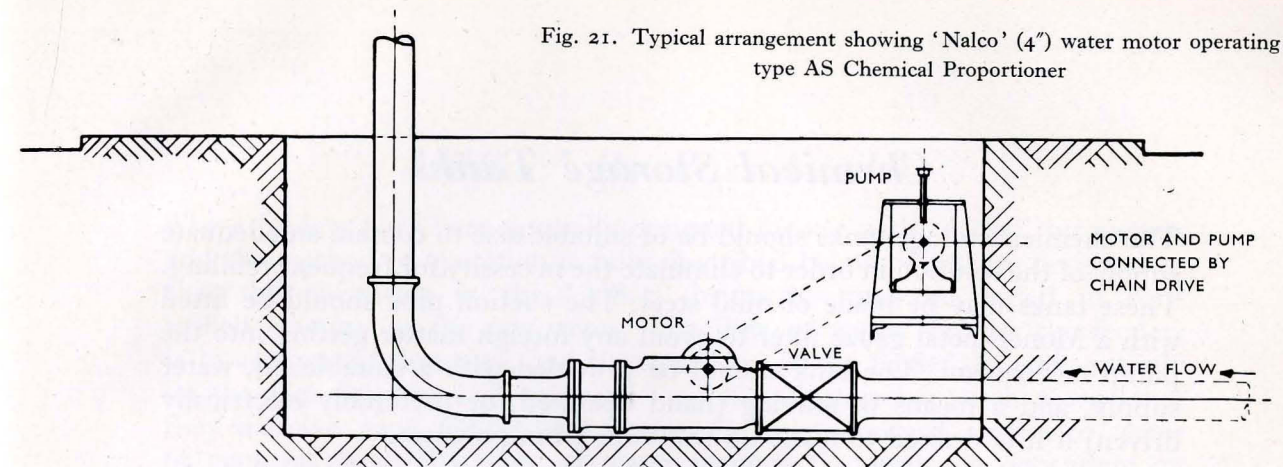
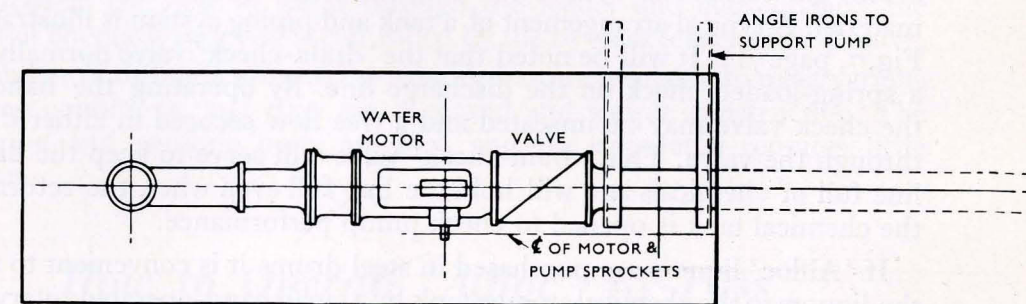

Fig. 20. Typical curves showing performance of 'Nalco' (6") water motor

Water Motor Size	Minimum Capacity Gallons per minute	Length Flange to Flange	Diameter of Drive Shaft
4"	60 Imperial gallons	22½"	7/8"
6"	125 " "	28½"	1"
8"	415 " "	24¾"	1 1/8"
10"	835 " "	25"	1 1/8"
12"	835 " "	25"	1 1/8"



SIDE ELEVATION



PLAN

Fig. 22. Typical installation of 'Nalco' (12") water motor and AS Chemical Proportioner feeding two water columns

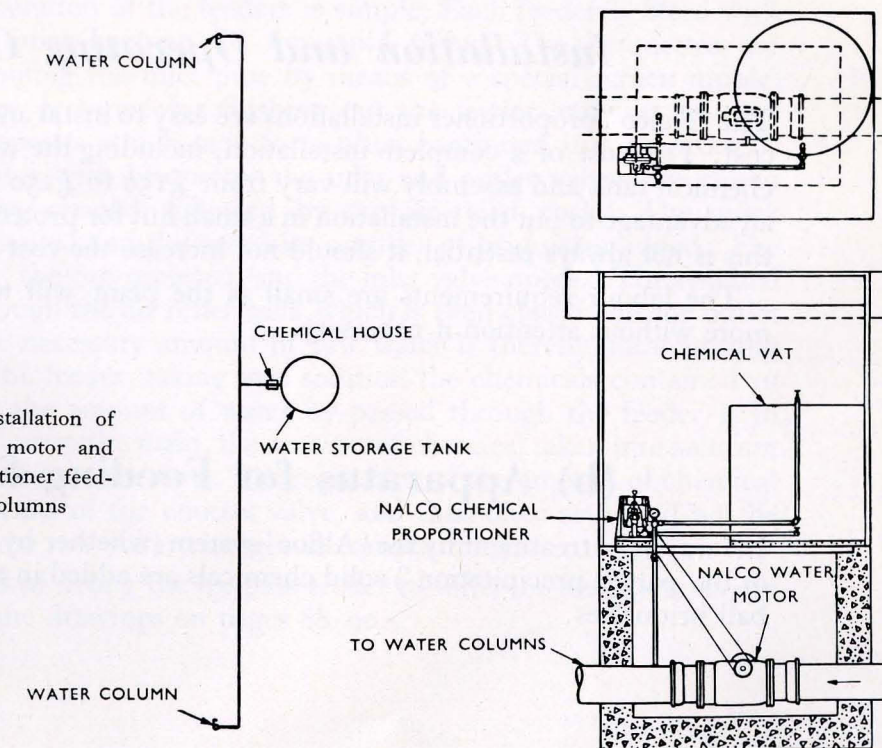

## *Chemical Storage Tanks*

The chemical storage tanks should be of suitable size to contain an adequate supply of the solution in order to eliminate the necessity for frequent refilling. These tanks may be made of mild steel. The suction pipe should be fitted with a Monel metal gauze filter to avoid any foreign matter getting into the pump mechanism. The tank should be provided with a suitable lid, water supply, and a means of stirring (hand operated, or preferably electrically driven) if it is desired to make up solutions from powders.

For handling caustic soda or liquors containing sodium aluminate it is desirable that pipes and fittings should be of iron or mild steel, ungalvanized, this avoids gas formation by reaction between the reagents and the galvanizing material. A typical arrangement of a tank and piping system is illustrated (see Fig. 7, page 71). It will be noted that the 'drain-check' valve normally acts as a spring-loaded check on the discharge line. By operating the hand wheel the check valve may be unseated and a free flow secured in either direction through the valve. This 'drain-check' valve will serve to keep the discharge line full of chemicals and will hold the line full even when the return line to the chemical tank is opened to check pump performance.

If 'Alfloc' liquors are purchased in steel drums it is convenient to transfer the liquors to the chemical storage tank by a small hand-operated rotary pump.

## *Installation and Operating Costs*

The 'Nalco' proportioner installations are easy to instal and are low in capital cost. The cost of a complete installation, including the water motor, pump, chemical tank and assembly will vary from £150 to £250 sterling. It may be an advantage to put the installation in a small hut for protection, and although this is not always essential, it should not increase the cost materially.

The labour requirements are small as the plant will work for a week or more without attention if necessary.

## **(b) Apparatus for Feeding Solids**

In 'wayside' treatment by the 'Alfloc' system (whether by 'deferred reaction' or by 'partial precipitation') solid chemicals are added in the form of 'Alfloc' ball briquettes.

## *'Alfloc' By-Pass Feeders*

These feeders have been specially designed for use with 'Alfloc' briquettes, and the method of operation is fully described below. They are designed so that the chemicals in the 'Alfloc' briquettes may be added in controlled amounts to the raw water. The flow of water through the feeders is in an upward direction, and the operation of the feeder depends entirely on the fact that the ball briquettes are manufactured in such a way that they dissolve away slowly and uniformly in an upward stream of water of constant flow. The flow of water through the feeder is dependent on a difference of pressure artificially created either by a valve, diaphragm, or other suitable device inserted in the main flow between the outlet and inlet of the feeder; the flow of water through the feeder and consequently the amount of chemical supplied is controlled by the by-pass feeder control valve.

A number of different sizes of by-pass feeders are available to meet various operating conditions, and they are of sound and simple construction. The installation and working costs are low, and the apparatus requires little attention.

## *How to Operate 'Alfloc' By-Pass Feeders*

The method of operation of the feeders is simple. Each feeder is fitted with a hand-operated quick-opening lid for rapid filling. The briquettes are prevented from fouling the inlet pipe by means of a special screen nipple. Suitable means are provided for flushing out the feeder and for the easy removal of any deposits which may form after continued use. In order to charge the apparatus with briquettes the inlet and outlet valves are closed and the drain valve opened, followed by the air relief cocks. The quick opening cap is removed and the requisite number of briquettes added. The drain valve is shut, the cap replaced, and the inlet valve opened. The residual air is removed through the air relief cock, which is then closed and the outlet valve opened. The necessary amount of raw water is thereby automatically shunted through the feeder, taking into solution the chemicals contained in the briquettes. As the amount of water by-passed through the feeder is in proportion to the flow in the main, the amount of chemical taken into solution is in direct relationship to the flow. The regulation of the amount of chemical treatment is by means of the control valve, and this, once set, need not be disturbed (unless the raw water changes in composition).

Various methods of fitting the by-pass feeder to different feed systems are illustrated in the line drawings on pages 88-90.

## Types of 'Alfloc' By-Pass Feeders

Each standard feeder is suitable for operating up to the undermentioned pressures and the following standard sizes are available:

'Alfloc' By-pass Feeder	Suitable for Operating up to	Briquette Capacity	Over-all Dimensions		Net weight without fittings lb.
			Height in ins.	Width in ins.	
No. 1	150 lbs./sq. in.	10	25	8½	67
2	150 lbs./sq. in.	30	32	11	115
3	110 lbs./sq. in.	65	56	14	149
4	90 lbs./sq. in.	200	72	18	230

In the case of Nos. 1 and 2 feeders 2½" is included in the height for the amount of projection of the screen nipple fitted in the base.

In the case of Nos. 3 and 4 sizes 14" is included in the height for the amount of projection of the screen nipple, the steel cross and the flanged stand pipe, which are fitted in position before despatch.

By-pass feeders suitable for working pressures higher than those mentioned in the above list can be supplied specially on request, provided full details are given to Alfloc Limited.

A typical installation is shown opposite.

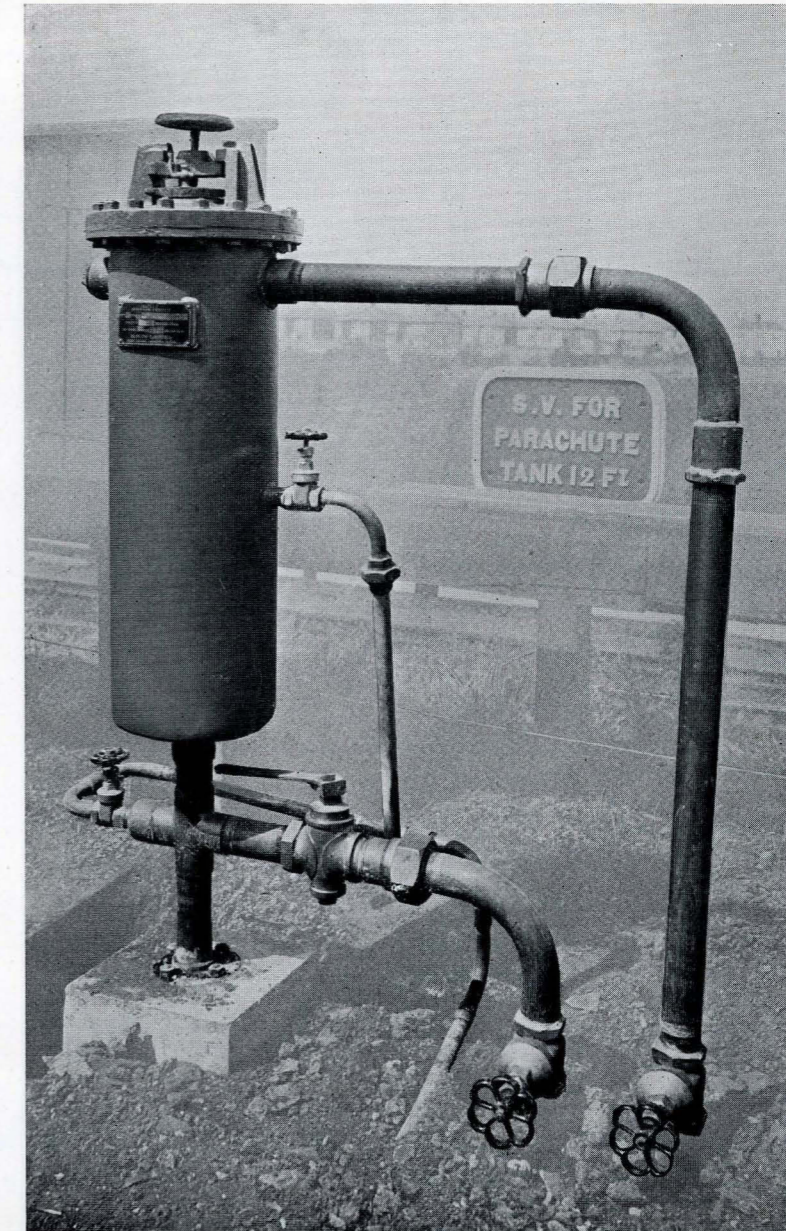

Fig. 23. Typical 'Alfloc' No. 3. By-pass Feeder installation feeding Parachute Tank

## Installation of By-Pass Feeders

It is desirable to insert an orifice plate or a 'throttling valve' in the main supply to maintain a flow of water through the feeder; if this is not possible the flow should be maintained by the use of suitable directional nipples inserted in the main supply line.

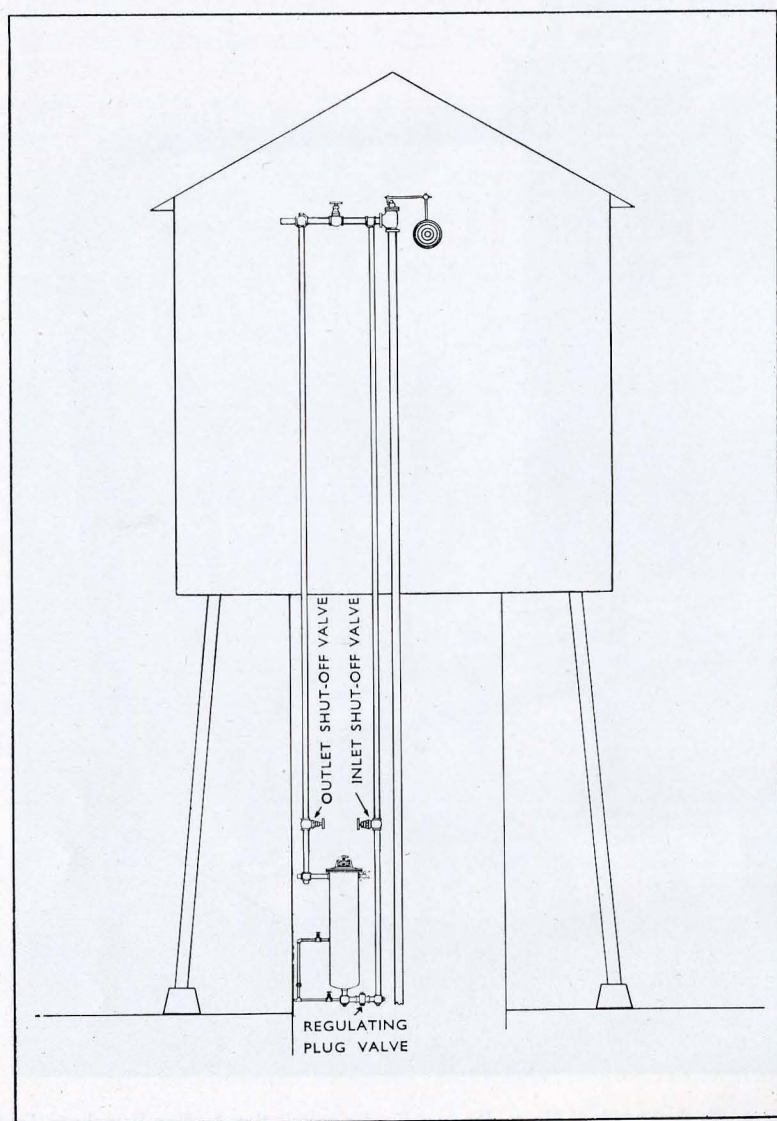

Fig. 24. Typical By-pass Feeder lay-out for 'deferred reaction' method

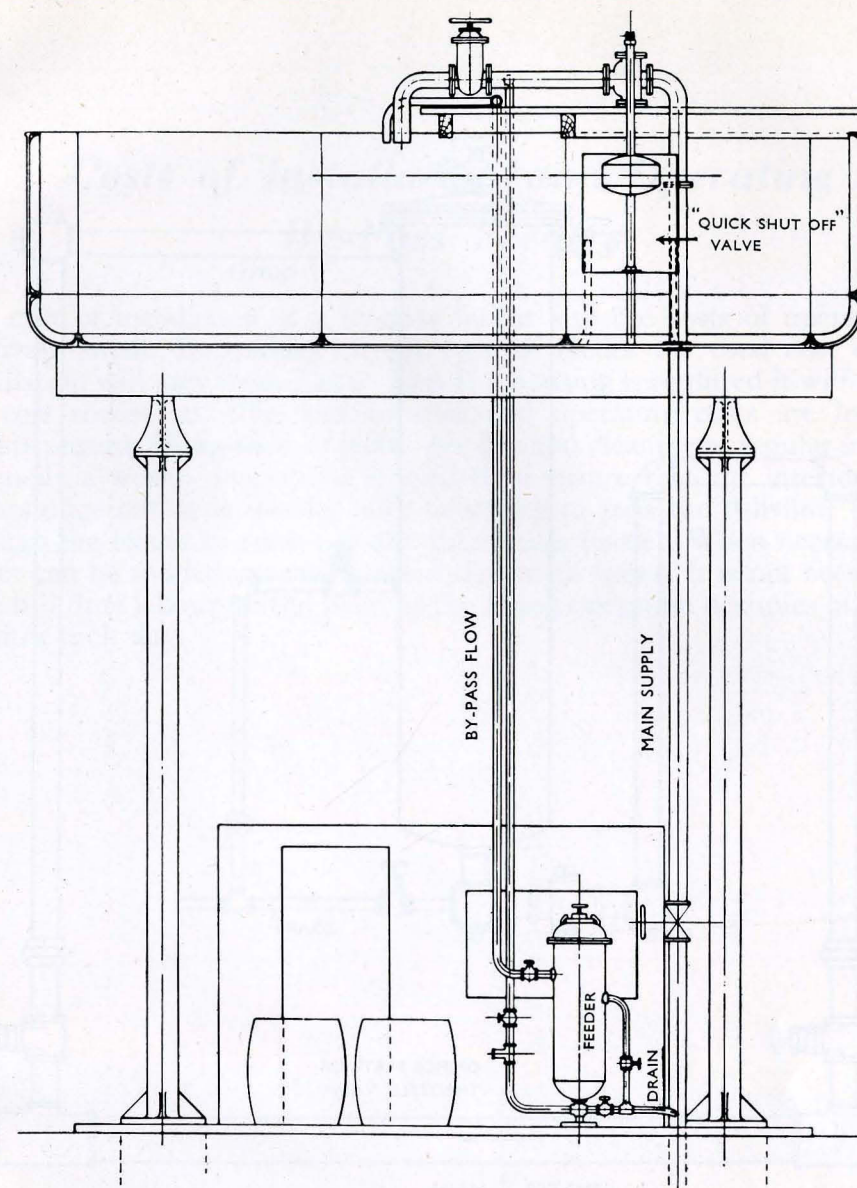

Fig. 25. Typical arrangement of By-pass Feeder layout for 'partial precipitation' method of 'wayside' treatment

### 'Partial Precipitation' Method

When the chemicals are to be fed to water which is flowing into a storage tank, the feeder should be fitted as shown above. As already mentioned, some means of ensuring an adequate flow through the feeder must be arranged, but in this case the outlet from the feeder is led by a separate pipe direct to the top of the tank; the discharge from this pipe should deliver into the tank in such a manner that good mixing is obtained. If the supply is intermittent it is desirable to instal a quick-acting valve operating at certain predetermined high and low levels in the tank (instead of the more usual slow operating float valve) to ensure that the flow through the feeder is always at the rate for which it is set, i.e. the flow will either be stopped or will proceed at a constant predetermined rate.

## Costs of Installation and Operating By-Pass Feeders

The cost of installation of a by-pass feeder and the costs of operation are relatively small. Depending on the type of feeder the total cost of plant installation will vary from £25 to £50. If a housing is required it will increase the cost somewhat. The maintenance and operating costs are low. The feeders require filling once or twice per day and cleaning at regular intervals. Normally a weekly inspection is needed to ensure that the interior is free from sludge and it is usually only necessary to pass the full flow of water through the feeder to wash out any extraneous matter. When necessary, the feeder can be rodded out and flushed clear with water. It is not necessary to have full time labour on the plant as the filling operation occupies only a few minutes each day.

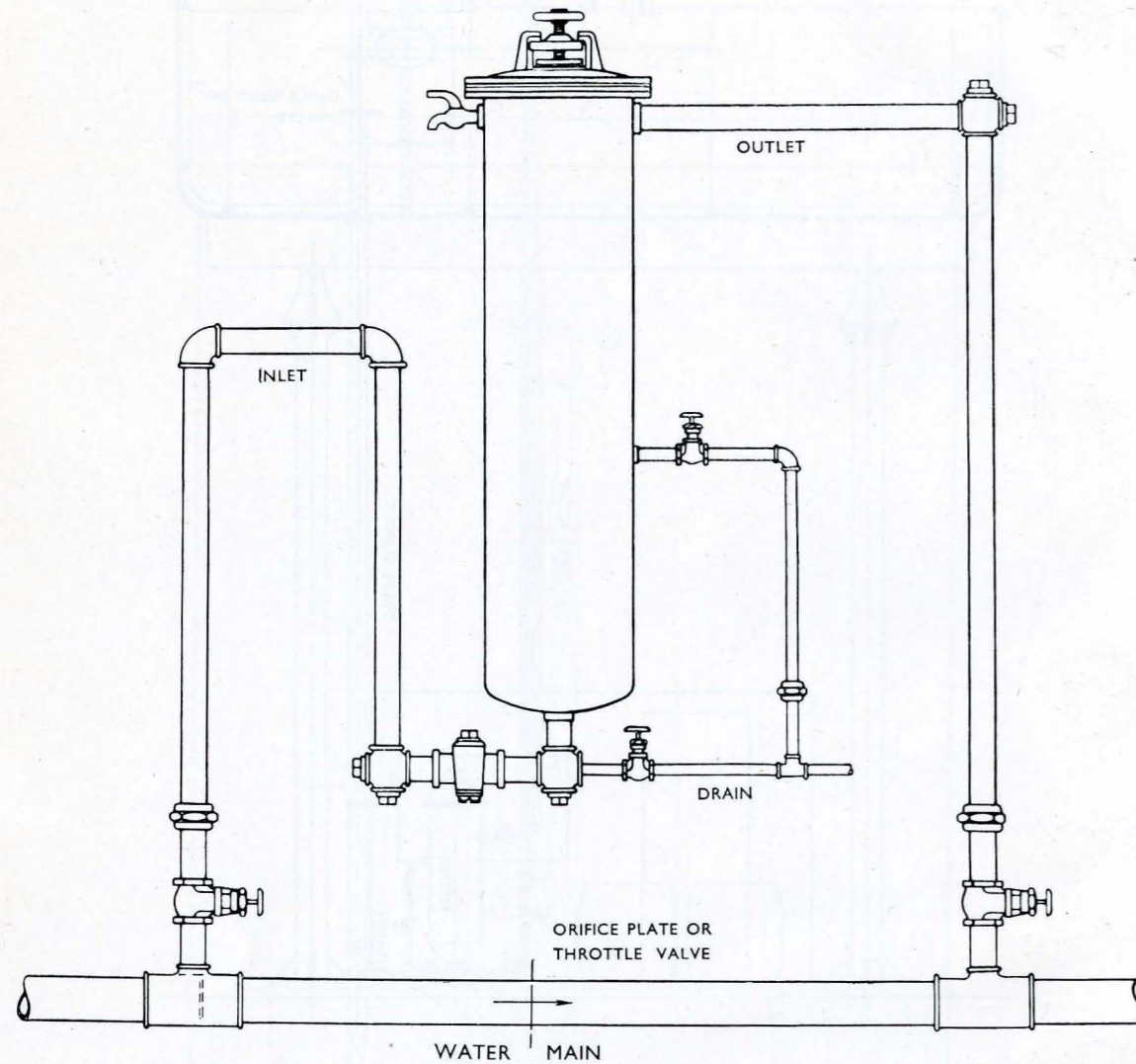

Fig. 26. Typical arrangement of By-pass Feeder for 'deferred reaction' method. Reagents delivered directly to water main

### 'Deferred Reaction' Method

When the chemicals are to be fed directly to a water main in the system of 'wayside' treatment by 'deferred reaction' the feeder should be erected as shown above.

# INDEX

<table border="0" style="width: 100%;"> <tr> <td style="width: 80%;">ACID WATER</td> <td style="text-align: right;">Page</td> </tr> <tr> <td>Neutralization . . . . .</td> <td style="text-align: right;">21</td> </tr> <tr> <td>Organic Matter . . . . .</td> <td style="text-align: right;">21</td> </tr> <tr> <td> AFTER PRECIPITATION . . . . .</td> <td style="text-align: right; vertical-align: bottom;">23, 33, 35</td> </tr> <tr> <td> 'ALFLOC' ANTIFOAM</td> <td></td> </tr> <tr> <td>Composition . . . . .</td> <td style="text-align: right;">51, 63</td> </tr> <tr> <td>Quantities used . . . . .</td> <td style="text-align: right;">51</td> </tr> <tr> <td>Use . . . . .</td> <td style="text-align: right;">51, 53</td> </tr> <tr> <td> 'ALFLOC' BRIQUETTES (see also BRIQUETTES and 'ALFLOC' No. 58 FORMULA)</td> <td></td> </tr> <tr> <td>Composition . . . . .</td> <td style="text-align: right;">61, 62, 63</td> </tr> <tr> <td>Corrosion . . . . .</td> <td style="text-align: right;">62</td> </tr> <tr> <td>Cost . . . . .</td> <td style="text-align: right;">62</td> </tr> <tr> <td>Feeding (see also BY-PASS FEEDERS)</td> <td></td> </tr> <tr> <td style="padding-left: 20px;">39, 41, 61</td> <td></td> </tr> <tr> <td>No. 11 . . . . .</td> <td style="text-align: right;">62</td> </tr> <tr> <td>No. 42-ABB . . . . .</td> <td style="text-align: right;">62</td> </tr> <tr> <td>Scale . . . . .</td> <td style="text-align: right;">62</td> </tr> <tr> <td>Solubility . . . . .</td> <td style="text-align: right;">61</td> </tr> <tr> <td>Types of Water . . . . .</td> <td style="text-align: right;">62</td> </tr> <tr> <td>'Wayside' Treatment . . . . .</td> <td style="text-align: right;">39, 41, 61, 62</td> </tr> <tr> <td>Weight . . . . .</td> <td style="text-align: right;">61</td> </tr> <tr> <td> 'ALFLOC' NO. 11 BRIQUETTES</td> <td></td> </tr> <tr> <td>Composition . . . . .</td> <td style="text-align: right;">62</td> </tr> <tr> <td>Sodium Phosphate . . . . .</td> <td style="text-align: right;">62</td> </tr> <tr> <td>Types of Water . . . . .</td> <td style="text-align: right;">62</td> </tr> <tr> <td>Uses . . . . .</td> <td style="text-align: right;">62</td> </tr> <tr> <td> 'ALFLOC' No. 42-ABB BRIQUETTES</td> <td></td> </tr> <tr> <td>Advantages . . . . .</td> <td style="text-align: right;">62</td> </tr> <tr> <td>Composition . . . . .</td> <td style="text-align: right;">62</td> </tr> <tr> <td>Corrosion . . . . .</td> <td style="text-align: right;">62</td> </tr> <tr> <td>Cost . . . . .</td> <td style="text-align: right;">62</td> </tr> <tr> <td>'Deferred Reaction' . . . . .</td> <td style="text-align: right;">62</td> </tr> <tr> <td>'Partial Precipitation' . . . . .</td> <td style="text-align: right;">62</td> </tr> <tr> <td>Scale . . . . .</td> <td style="text-align: right;">62</td> </tr> <tr> <td>Types of Water . . . . .</td> <td style="text-align: right;">62</td> </tr> <tr> <td> 'ALFLOC' No. 58 FORMULA</td> <td></td> </tr> <tr> <td>Addition . . . . .</td> <td style="text-align: right;">21</td> </tr> <tr> <td>Amount Required . . . . .</td> <td style="text-align: right;">43, 53</td> </tr> <tr> <td>Briquettes . . . . .</td> <td style="text-align: right;">39, 43, 63</td> </tr> <tr> <td>Composition . . . . .</td> <td style="text-align: right;">43, 63</td> </tr> <tr> <td>Corrosion . . . . .</td> <td style="text-align: right;">21, 43, 45, 53</td> </tr> <tr> <td>Incrustation . . . . .</td> <td style="text-align: right;">39, 43</td> </tr> <tr> <td>Lime-Soda Process . . . . .</td> <td style="text-align: right;">27</td> </tr> <tr> <td>Oxygen Removal . . . . .</td> <td style="text-align: right;">21, 45</td> </tr> <tr> <td>Powder . . . . .</td> <td style="text-align: right;">39, 43, 63</td> </tr> <tr> <td>Stabilisation . . . . .</td> <td style="text-align: right;">39, 43</td> </tr> <tr> <td>'Wayside' Treatment . . . . .</td> <td style="text-align: right;">39, 63</td> </tr> <tr> <td> 'ALFLOC' LIQUORS</td> <td></td> </tr> <tr> <td>Composition . . . . .</td> <td style="text-align: right;">39, 60, 61</td> </tr> <tr> <td>Feeding (see also LIQUID FEED)</td> <td style="text-align: right;">39, 60, 64</td> </tr> </table>	ACID WATER	Page	Neutralization . . . . .	21	Organic Matter . . . . .	21	 AFTER PRECIPITATION . . . . .	23, 33, 35	 'ALFLOC' ANTIFOAM		Composition . . . . .	51, 63	Quantities used . . . . .	51	Use . . . . .	51, 53	 'ALFLOC' BRIQUETTES (see also BRIQUETTES and 'ALFLOC' No. 58 FORMULA)		Composition . . . . .	61, 62, 63	Corrosion . . . . .	62	Cost . . . . .	62	Feeding (see also BY-PASS FEEDERS)		39, 41, 61		No. 11 . . . . .	62	No. 42-ABB . . . . .	62	Scale . . . . .	62	Solubility . . . . .	61	Types of Water . . . . .	62	'Wayside' Treatment . . . . .	39, 41, 61, 62	Weight . . . . .	61	 'ALFLOC' NO. 11 BRIQUETTES		Composition . . . . .	62	Sodium Phosphate . . . . .	62	Types of Water . . . . .	62	Uses . . . . .	62	 'ALFLOC' No. 42-ABB BRIQUETTES		Advantages . . . . .	62	Composition . . . . .	62	Corrosion . . . . .	62	Cost . . . . .	62	'Deferred Reaction' . . . . .	62	'Partial Precipitation' . . . . .	62	Scale . . . . .	62	Types of Water . . . . .	62	 'ALFLOC' No. 58 FORMULA		Addition . . . . .	21	Amount Required . . . . .	43, 53	Briquettes . . . . .	39, 43, 63	Composition . . . . .	43, 63	Corrosion . . . . .	21, 43, 45, 53	Incrustation . . . . .	39, 43	Lime-Soda Process . . . . .	27	Oxygen Removal . . . . .	21, 45	Powder . . . . .	39, 43, 63	Stabilisation . . . . .	39, 43	'Wayside' Treatment . . . . .	39, 63	 'ALFLOC' LIQUORS		Composition . . . . .	39, 60, 61	Feeding (see also LIQUID FEED)	39, 60, 64
ACID WATER	Page																																																																																																			
Neutralization . . . . .	21																																																																																																			
Organic Matter . . . . .	21																																																																																																			
 AFTER PRECIPITATION . . . . .	23, 33, 35																																																																																																			
 'ALFLOC' ANTIFOAM																																																																																																				
Composition . . . . .	51, 63																																																																																																			
Quantities used . . . . .	51																																																																																																			
Use . . . . .	51, 53																																																																																																			
 'ALFLOC' BRIQUETTES (see also BRIQUETTES and 'ALFLOC' No. 58 FORMULA)																																																																																																				
Composition . . . . .	61, 62, 63																																																																																																			
Corrosion . . . . .	62																																																																																																			
Cost . . . . .	62																																																																																																			
Feeding (see also BY-PASS FEEDERS)																																																																																																				
39, 41, 61																																																																																																				
No. 11 . . . . .	62																																																																																																			
No. 42-ABB . . . . .	62																																																																																																			
Scale . . . . .	62																																																																																																			
Solubility . . . . .	61																																																																																																			
Types of Water . . . . .	62																																																																																																			
'Wayside' Treatment . . . . .	39, 41, 61, 62																																																																																																			
Weight . . . . .	61																																																																																																			
 'ALFLOC' NO. 11 BRIQUETTES																																																																																																				
Composition . . . . .	62																																																																																																			
Sodium Phosphate . . . . .	62																																																																																																			
Types of Water . . . . .	62																																																																																																			
Uses . . . . .	62																																																																																																			
 'ALFLOC' No. 42-ABB BRIQUETTES																																																																																																				
Advantages . . . . .	62																																																																																																			
Composition . . . . .	62																																																																																																			
Corrosion . . . . .	62																																																																																																			
Cost . . . . .	62																																																																																																			
'Deferred Reaction' . . . . .	62																																																																																																			
'Partial Precipitation' . . . . .	62																																																																																																			
Scale . . . . .	62																																																																																																			
Types of Water . . . . .	62																																																																																																			
 'ALFLOC' No. 58 FORMULA																																																																																																				
Addition . . . . .	21																																																																																																			
Amount Required . . . . .	43, 53																																																																																																			
Briquettes . . . . .	39, 43, 63																																																																																																			
Composition . . . . .	43, 63																																																																																																			
Corrosion . . . . .	21, 43, 45, 53																																																																																																			
Incrustation . . . . .	39, 43																																																																																																			
Lime-Soda Process . . . . .	27																																																																																																			
Oxygen Removal . . . . .	21, 45																																																																																																			
Powder . . . . .	39, 43, 63																																																																																																			
Stabilisation . . . . .	39, 43																																																																																																			
'Wayside' Treatment . . . . .	39, 63																																																																																																			
 'ALFLOC' LIQUORS																																																																																																				
Composition . . . . .	39, 60, 61																																																																																																			
Feeding (see also LIQUID FEED)	39, 60, 64																																																																																																			

 |                                     |                                    | |-------------------------------------|------------------------------------| | 'ALFLOC' LIQUORS—continued.         | Page                               | | Handling . . . . .                  | 84                                 | | No. 3R Liquor . . . . .             | 61                                 | | No. 4R Liquor . . . . .             | 60                                 | | Stabilised . . . . .                | 60                                 | | Storage . . . . .                   | 84                                 | | Types of Water . . . . .            | 61                                 | | 'Wayside' Treatment . . . . .       | 39, 60, 61                         | | <br>'ALFLOC' No. 3R LIQUOR          |                                    | | Composition . . . . .               | 61                                 | | Cost of Treatment . . . . .         | 61                                 | | Description . . . . .               | 61                                 | | Types of Water . . . . .            | 61                                 | | 'Wayside' Treatment . . . . .       | 61                                 | | <br>'ALFLOC' No. 4R LIQUOR          |                                    | | Coagulation . . . . .               | 60                                 | | Composition . . . . .               | 60                                 | | Cost of Treatment . . . . .         | 61                                 | | Description . . . . .               | 60                                 | | Handling . . . . .                  | 60                                 | | Packing . . . . .                   | 61                                 | | Proportioning Apparatus . . . . .   | 60                                 | | Types of Water . . . . .            | 61                                 | | 'Wayside' Treatment . . . . .       | 60, 61                             | | <br>'ALFLOC' No. 28 POWDER          |                                    | | Composition . . . . .               | 62                                 | | Corrosion . . . . .                 | 62, 63                             | | Scale . . . . .                     | 63                                 | | Silica . . . . .                    | 63                                 | | Soft Water . . . . .                | 63                                 | | Uses . . . . .                      | 62                                 | | <br>ALKALIS                         |                                    | | Neutralization of Acidity . . . . . | 21                                 | | Special Mixtures . . . . .          | 63                                 | | 'Wayside' Treatment . . . . .       | 21, 39, 41, 62                     | | <br>ALKALINITY                      |                                    | | Caustic . . . . .                   | 23, 43                             | | Caustic Embrittlement . . . . .     | 43                                 | | Control . . . . .                   | 39, 43, 51, 53                     | | Corrosion . . . . .                 | 33, 37, 39, 41, 43, 45             | | Excess . . . . .                    | 35, 37, 39, 41, 43, 51, 53, 61, 63 | | Feed Water . . . . .                | 31, 33, 37, 39, 51, 53             | | <br>ALUMINIUM                       |                                    | | Hydroxide . . . . .                 | 31, 33                             | | Salts . . . . .                     | 19                                 | | <br>ALUMINIUM SULPHATE              |                                    | | Organic Matter Removal . . . . .    | 21                                 | | Sodium Aluminate . . . . .          | 21                                 | |

<table border="0" style="width: 100%;"> <tr> <td style="width: 80%;">AMERICAN RAILWAYS</td> <td style="text-align: right;">Page</td> </tr> <tr> <td>Engineering Association Formulæ . . . . .</td> <td style="text-align: right;">15, 43</td> </tr> <tr> <td> ANALYSIS</td> <td></td> </tr> <tr> <td>Water . . . . .</td> <td style="text-align: right;">55, 57</td> </tr> <tr> <td> ANTIFOAM</td> <td></td> </tr> <tr> <td>Composition . . . . .</td> <td style="text-align: right;">51, 63</td> </tr> <tr> <td>Use . . . . .</td> <td style="text-align: right;">51, 53</td> </tr> <tr> <td> APPORTIONING GEAR (see also PRO- PORTIONING APPARATUS)</td> <td style="text-align: right; vertical-align: bottom;">27, 39, 43</td> </tr> <tr> <td>Lime-Soda . . . . .</td> <td style="text-align: right;">27</td> </tr> <tr> <td>Liquid Feed (see Solid Feed (see BY-PASS FEEDERS)</td> <td></td> </tr> <tr> <td>'Wayside' Treatment . . . . .</td> <td style="text-align: right;">39, 60, 63, 64</td> </tr> <tr> <td> BIBLIOGRAPHY . . . . .</td> <td style="text-align: right; vertical-align: bottom;">58</td> </tr> <tr> <td> 'BLOWDOWN' . . . . .</td> <td style="text-align: right; vertical-align: bottom;">37, 43, 47, 49, 51, 53</td> </tr> <tr> <td>Amount . . . . .</td> <td style="text-align: right;">49</td> </tr> <tr> <td>Automatic . . . . .</td> <td style="text-align: right;">47</td> </tr> <tr> <td>Continuous . . . . .</td> <td style="text-align: right;">47, 53</td> </tr> <tr> <td>Cost . . . . .</td> <td style="text-align: right;">49</td> </tr> <tr> <td>Fuel Consumption . . . . .</td> <td style="text-align: right;">49</td> </tr> <tr> <td>Heat Recovery . . . . .</td> <td style="text-align: right;">49, 51</td> </tr> <tr> <td>Intermittent . . . . .</td> <td style="text-align: right;">47, 49</td> </tr> <tr> <td>Noise Elimination . . . . .</td> <td style="text-align: right;">49</td> </tr> <tr> <td>Saline Waters . . . . .</td> <td style="text-align: right;">51</td> </tr> <tr> <td>Temperature . . . . .</td> <td style="text-align: right;">49</td> </tr> <tr> <td>Track, effect on . . . . .</td> <td style="text-align: right;">49</td> </tr> <tr> <td>Valves . . . . .</td> <td style="text-align: right;">47, 49, 53</td> </tr> <tr> <td> BOILERS . . . . .</td> <td style="text-align: right; vertical-align: bottom;">13</td> </tr> <tr> <td>Design . . . . .</td> <td style="text-align: right;">45, 53</td> </tr> <tr> <td>Efficiency . . . . .</td> <td style="text-align: right;">49</td> </tr> <tr> <td>Experimental . . . . .</td> <td style="text-align: right;">45</td> </tr> <tr> <td>High Pressure . . . . .</td> <td style="text-align: right;">63</td> </tr> <tr> <td>Leakage . . . . .</td> <td style="text-align: right;">13</td> </tr> <tr> <td>Life . . . . .</td> <td style="text-align: right;">13, 15, 17, 43, 45</td> </tr> <tr> <td>Maintenance . . . . .</td> <td style="text-align: right;">15</td> </tr> <tr> <td>Repairs . . . . .</td> <td style="text-align: right;">15</td> </tr> <tr> <td>Stationary . . . . .</td> <td style="text-align: right;">11, 17</td> </tr> <tr> <td>Tubes . . . . .</td> <td style="text-align: right;">13, 47</td> </tr> <tr> <td>Washouts . . . . .</td> <td style="text-align: right;">13, 45, 47, 49, 51, 53</td> </tr> <tr> <td>Water (see WATER)</td> <td></td> </tr> <tr> <td> BRIQUETTES (see also 'ALFLOC')</td> <td></td> </tr> <tr> <td>'Alfloc' No. 11 . . . . .</td> <td style="text-align: right;">62</td> </tr> <tr> <td>'Alfloc' No. 42 ABB . . . . .</td> <td style="text-align: right;">62</td> </tr> <tr> <td>'Alfloc' No. 58 formula . . . . .</td> <td style="text-align: right;">43, 63</td> </tr> <tr> <td>Composition . . . . .</td> <td style="text-align: right;">61, 62, 63</td> </tr> <tr> <td>Corrosion . . . . .</td> <td style="text-align: right;">62</td> </tr> <tr> <td>Cost . . . . .</td> <td style="text-align: right;">62</td> </tr> <tr> <td>'Deferred Reaction' . . . . .</td> <td style="text-align: right;">62, 84</td> </tr> <tr> <td>Feeding (see also BY-PASS FEEDERS)</td> <td></td> </tr> <tr> <td style="padding-left: 20px;">39, 41, 43, 64</td> <td></td> </tr> <tr> <td>'Partial Precipitation' . . . . .</td> <td style="text-align: right;">62, 84</td> </tr> <tr> <td>Scale . . . . .</td> <td style="text-align: right;">62</td> </tr> <tr> <td>Silica Scale . . . . .</td> <td style="text-align: right;">62</td> </tr> <tr> <td>Solubility . . . . .</td> <td style="text-align: right;">61, 85</td> </tr> <tr> <td>Types of Water . . . . .</td> <td style="text-align: right;">62</td> </tr> <tr> <td>'Wayside' Treatment . . . . .</td> <td style="text-align: right;">39, 41, 61, 62, 63</td> </tr> <tr> <td>Weight . . . . .</td> <td style="text-align: right;">61</td> </tr> </table>	AMERICAN RAILWAYS	Page	Engineering Association Formulæ . . . . .	15, 43	 ANALYSIS		Water . . . . .	55, 57	 ANTIFOAM		Composition . . . . .	51, 63	Use . . . . .	51, 53	 APPORTIONING GEAR (see also PRO- PORTIONING APPARATUS)	27, 39, 43	Lime-Soda . . . . .	27	Liquid Feed (see Solid Feed (see BY-PASS FEEDERS)		'Wayside' Treatment . . . . .	39, 60, 63, 64	 BIBLIOGRAPHY . . . . .	58	 'BLOWDOWN' . . . . .	37, 43, 47, 49, 51, 53	Amount . . . . .	49	Automatic . . . . .	47	Continuous . . . . .	47, 53	Cost . . . . .	49	Fuel Consumption . . . . .	49	Heat Recovery . . . . .	49, 51	Intermittent . . . . .	47, 49	Noise Elimination . . . . .	49	Saline Waters . . . . .	51	Temperature . . . . .	49	Track, effect on . . . . .	49	Valves . . . . .	47, 49, 53	 BOILERS . . . . .	13	Design . . . . .	45, 53	Efficiency . . . . .	49	Experimental . . . . .	45	High Pressure . . . . .	63	Leakage . . . . .	13	Life . . . . .	13, 15, 17, 43, 45	Maintenance . . . . .	15	Repairs . . . . .	15	Stationary . . . . .	11, 17	Tubes . . . . .	13, 47	Washouts . . . . .	13, 45, 47, 49, 51, 53	Water (see WATER)		 BRIQUETTES (see also 'ALFLOC')		'Alfloc' No. 11 . . . . .	62	'Alfloc' No. 42 ABB . . . . .	62	'Alfloc' No. 58 formula . . . . .	43, 63	Composition . . . . .	61, 62, 63	Corrosion . . . . .	62	Cost . . . . .	62	'Deferred Reaction' . . . . .	62, 84	Feeding (see also BY-PASS FEEDERS)		39, 41, 43, 64		'Partial Precipitation' . . . . .	62, 84	Scale . . . . .	62	Silica Scale . . . . .	62	Solubility . . . . .	61, 85	Types of Water . . . . .	62	'Wayside' Treatment . . . . .	39, 41, 61, 62, 63	Weight . . . . .	61
AMERICAN RAILWAYS	Page																																																																																																													
Engineering Association Formulæ . . . . .	15, 43																																																																																																													
 ANALYSIS																																																																																																														
Water . . . . .	55, 57																																																																																																													
 ANTIFOAM																																																																																																														
Composition . . . . .	51, 63																																																																																																													
Use . . . . .	51, 53																																																																																																													
 APPORTIONING GEAR (see also PRO- PORTIONING APPARATUS)	27, 39, 43																																																																																																													
Lime-Soda . . . . .	27																																																																																																													
Liquid Feed (see Solid Feed (see BY-PASS FEEDERS)																																																																																																														
'Wayside' Treatment . . . . .	39, 60, 63, 64																																																																																																													
 BIBLIOGRAPHY . . . . .	58																																																																																																													
 'BLOWDOWN' . . . . .	37, 43, 47, 49, 51, 53																																																																																																													
Amount . . . . .	49																																																																																																													
Automatic . . . . .	47																																																																																																													
Continuous . . . . .	47, 53																																																																																																													
Cost . . . . .	49																																																																																																													
Fuel Consumption . . . . .	49																																																																																																													
Heat Recovery . . . . .	49, 51																																																																																																													
Intermittent . . . . .	47, 49																																																																																																													
Noise Elimination . . . . .	49																																																																																																													
Saline Waters . . . . .	51																																																																																																													
Temperature . . . . .	49																																																																																																													
Track, effect on . . . . .	49																																																																																																													
Valves . . . . .	47, 49, 53																																																																																																													
 BOILERS . . . . .	13																																																																																																													
Design . . . . .	45, 53																																																																																																													
Efficiency . . . . .	49																																																																																																													
Experimental . . . . .	45																																																																																																													
High Pressure . . . . .	63																																																																																																													
Leakage . . . . .	13																																																																																																													
Life . . . . .	13, 15, 17, 43, 45																																																																																																													
Maintenance . . . . .	15																																																																																																													
Repairs . . . . .	15																																																																																																													
Stationary . . . . .	11, 17																																																																																																													
Tubes . . . . .	13, 47																																																																																																													
Washouts . . . . .	13, 45, 47, 49, 51, 53																																																																																																													
Water (see WATER)																																																																																																														
 BRIQUETTES (see also 'ALFLOC')																																																																																																														
'Alfloc' No. 11 . . . . .	62																																																																																																													
'Alfloc' No. 42 ABB . . . . .	62																																																																																																													
'Alfloc' No. 58 formula . . . . .	43, 63																																																																																																													
Composition . . . . .	61, 62, 63																																																																																																													
Corrosion . . . . .	62																																																																																																													
Cost . . . . .	62																																																																																																													
'Deferred Reaction' . . . . .	62, 84																																																																																																													
Feeding (see also BY-PASS FEEDERS)																																																																																																														
39, 41, 43, 64																																																																																																														
'Partial Precipitation' . . . . .	62, 84																																																																																																													
Scale . . . . .	62																																																																																																													
Silica Scale . . . . .	62																																																																																																													
Solubility . . . . .	61, 85																																																																																																													
Types of Water . . . . .	62																																																																																																													
'Wayside' Treatment . . . . .	39, 41, 61, 62, 63																																																																																																													
Weight . . . . .	61																																																																																																													

 |  |                        | |--|------------------------| | BY-PASS FEEDERS                                      | Page                   | | 'Alfloc' Briquettes . . . . .                        | 43, 84                 | | Capacities . . . . .                                 | 39, 41, 43, 64, 84, 85 | | Cleaning . . . . .                                   | 86                     | | Control . . . . .                                    | 85, 91                 | | Costs . . . . .                                      | 85                     | | 'Deferred Reaction' . . . . .                        | 91                     | | Design . . . . .                                     | 90                     | | Filling . . . . .                                    | 85                     | | Installation . . . . .                               | 85, 91                 | | Operation . . . . .                                  | 86, 87, 88, 89, 90, 91 | | 'Partial Precipitation' . . . . .                    | 85, 87, 89, 91         | | Sizes . . . . .                                      | 89                     | | Special . . . . .                                    | 85, 86                 | | Types . . . . .                                      | 86                     | | Working Pressure . . . . .                           | 85, 86                 | | <br>CALCIUM  |                        | | Bicarbonate . . . . .                                | 19, 21, 23             | | Carbonate . . . . .                                  | 19, 21, 23, 33, 39, 55 | | Chloride . . . . .                                   | 19, 27                 | | Hydroxide (see HYDRATED LIME)                        |                        | | Nitrate . . . . .                                    | 19                     | | Sulphate . . . . .                                   | 19, 47                 | | <br>CALCIUM SALTS . . . . .                          | 19, 23                 | | 'Calgon' . . . . .                                   | 62                     | | Complex . . . . .                                    | 62                     | | Permanent Hardness . . . . .                         | 23, 37, 47             | | Phosphate . . . . .                                  | 62, 63                 | | Silicate Scale . . . . .                             | 25                     | | Temporary Hardness . . . . .                         | 21, 23, 37, 39         | | <br>'CALGON'   |                        | | 'Alfloc' No. 28 Powder . . . . .                     | 62                     | | Composition . . . . .                                | 62                     | | Tannins . . . . .                                    | 62                     | | Uses . . . . .                                       | 62                     | | <br>CARBON DIOXIDE . . . . .                         | 17, 19, 55             | | Corrosion . . . . .                                  | 17, 19                 | | Formation . . . . .                                  | 19                     | | Pitting . . . . .                                    | 17                     | | Removal . . . . .                                    | 21, 31                 | | <br>CASTOR OIL . . . . .                             | 51, 63                 | | <br>CAUSTIC SODA . . . . .                           | 19                     | | Carbon Dioxide Removal . . . . .                     | 21                     | | Embrittlement . . . . .                              | 19                     | | Grades . . . . .                                     | 59                     | | Handling . . . . .                                   | 59, 84                 | | Lime-Soda Process . . . . .                          | 27                     | | Liquors . . . . .                                    | 60, 61, 84             | | Magnesium Salts . . . . .                            | 25, 39                 | | Packing . . . . .                                    | 59                     | | Purity . . . . .                                     | 59                     | | Safety Precautions . . . . .                         | 59                     | | Sodium Aluminate, from . . . . .                     | 31                     | | Solubility . . . . .                                 | 59                     | | 'Wayside' Treatment . . . . .                        | 21, 25, 39, 60, 61     | | <br>CAUSTIC ALKALINITY (see<br>ALKALINITY) . . . . . | 23, 43                 | |

	Page		Page
<b>CHEMICALS</b>			
Cost of . . . . .	55	'DEFERRED REACTION' (see 'WAYSIDE' TREATMENT)	
Description . . . . .	59		
Feeding of (see 'PLANT and APPORTIONING GEAR')		DEGREE OF HARDNESS . . . . .	19
Proprietary . . . . .	11, 25		
Quality . . . . .	11, 59	DISSOLVED GASES . . . . .	17, 21, 45, 62
Special Mixtures . . . . .	63	Carbon Dioxide . . . . .	17, 21
Storage Tanks . . . . .	84	Corrosion . . . . .	17, 45
Supply . . . . .	11, 41, 59	De-aeration . . . . .	21, 45
Wastage . . . . .	63	Oxygen . . . . .	17, 21, 45, 62
		Pitting . . . . .	17, 45
		Removal . . . . .	21, 45, 62
<b>CLARIFICATION</b>			
Lime-Soda Softening . . . . .	29	DISSOLVED SOLIDS (see SOLUBLE SALTS)	
<b>COAGULATION</b> . . . . .	47	ECONOMIES . . . . .	13, 15, 25
Colloids . . . . .	31	Assessment . . . . .	15
Filtration . . . . .	29	Fuel . . . . .	49
Lime-Soda Process . . . . .	29		
Organic Matter . . . . .	21	ECONOMISERS . . . . .	35
Sodium Aluminate . . . . .	23, 31, 60		
'Wayside' Treatment . . . . .	41	EMBRITTLMENT (Caustic) . . . . .	19, 43
		Prevention of . . . . .	19, 43
<b>COLLOIDS</b>			
After Precipitation . . . . .	23	EXTERNAL TREATMENT (see LIME- SODA PROCESS)	
Aluminium Hydroxide . . . . .	31		
Coagulation . . . . .	31	FEED WATER (see WATER)	
Electrical Charges . . . . .	31		
Magnesium Hydroxide . . . . .	23, 31	FERROUS SULPHATE . . . . .	27
Suspension . . . . .	19		
		FILTRATION	
<b>CONTROL</b>		Coagulants . . . . .	29, 35
Alkalinity . . . . .	33, 43	Lime-Soda Process . . . . .	27, 29, 35
Analytical . . . . .	57	Organic Matter . . . . .	21
Chemical Addition . . . . .	63		
Facilities . . . . .	57	FILTERS	
Soluble Salts . . . . .	39	Backwashing . . . . .	35
Treatment . . . . .	57	Life . . . . .	35
		Types of . . . . .	29
<b>CORROSION</b> . . . . .	13, 15, 41, 43		
'Alfloc' No. 28 Powder . . . . .	63	FLOCCULATION	
'Alfloc' No. 58 Formula . . . . .	43, 53	Colour Removal . . . . .	35
Alkalinity . . . . .	33, 37, 39, 41, 43, 53	Lime-Soda Process . . . . .	27, 29, 35
Boiler Life . . . . .	13	Sludge . . . . .	39
Boiler Water Composition . . . . .	43	Sodium Aluminate . . . . .	31, 33, 35
'Calgon' . . . . .	62		
Carbon Dioxide . . . . .	17	'FOAMING' (see 'PRIMING')	
Dissolved Gases . . . . .	17		
Dissolved Solids . . . . .	43	FUEL CONSUMPTION . . . . .	13, 15, 49
Magnesium Salts . . . . .	35, 39		
Mineral Salts . . . . .	19, 39	'GROOVING' . . . . .	13
Oxygen . . . . .	17, 21, 63		
Phosphates . . . . .	21, 43, 62	HANCOCK, J. S. . . . .	45
Tannins . . . . .	43, 45, 63		
Tubes . . . . .	13	HARDNESS (see also TEMPORARY HARDNESS, PERMANENT HARDNESS)	
'Wayside' Treatment . . . . .	35, 39, 51, 62	Calcium . . . . .	55
		Definition . . . . .	19
<b>DAMAGE</b> . . . . .	15		
Cost of . . . . .	15		
<b>DE-AERATION</b> . . . . .	21, 45		
<b>DECONCENTRATION</b>			
Boiler Water . . . . .	47		

	Page		Page
<b>HARDNESS—continued.</b>		<b>LIME-SODA PROCESS—continued.</b>	
'Degree' . . . . .	19	Coagulation . . . . .	21, 31, 35
Effect on Costs . . . . .	15, 33	Control . . . . .	57
Magnesium . . . . .	55	Efficiency . . . . .	31, 33, 35
Permanent . . . . .	19, 39, 41	Ferrous Sulphate . . . . .	27
Removal . . . . .	19, 21, 23, 25, 27, 33, 35, 37, 39, 41, 47, 51, 55	Flocculation . . . . .	27, 33, 35
		Hydrated Lime . . . . .	21, 23, 25, 27
Residual . . . . .	23, 33, 35, 39, 47, 51, 53	Labour Requirements . . . . .	37
Soap Test . . . . .	53	Limitations . . . . .	37, 55
Temporary . . . . .	19, 21, 23, 39, 41	Magnesium Salts Removal . . . . .	25, 33, 35
Total . . . . .	55	Magnesium Sulphate . . . . .	27
Water, of . . . . .	19	Operating Costs . . . . .	55, 57
		Organic Matter Removal . . . . .	21
<b>HEAT RECOVERY</b> . . . . .	49, 51	Permanent Hardness . . . . .	23, 25, 47, 57
		Plant (see)	
<b>HEAT TRANSFER</b> . . . . .	13	Plant throughput . . . . .	33, 35, 37
		Quicklime . . . . .	25
<b>HYDRATED LIME</b>		Reaction Period . . . . .	29
Carbon Dioxide Removal . . . . .	21	Reagents . . . . .	27
Composition . . . . .	59	Saline Waters . . . . .	51
'Limbux' . . . . .	25, 33, 59	Sedimentation . . . . .	29
Lime-Soda Process . . . . .	21, 27, 33	Silica Removal . . . . .	25, 35
Packing . . . . .	59	Sodium Aluminate . . . . .	23, 27, 31, 35, 51
Permanent Hardness . . . . .	25	Sodium Carbonate . . . . .	23, 25, 27
Purity . . . . .	59	Sodium Hydroxide Formation . . . . .	25
Silica Content . . . . .	25, 59	Sodium Salts . . . . .	25, 47
Temporary Hardness . . . . .	23	Supervision . . . . .	57
		Temporary Hardness . . . . .	23, 47, 57
<b>HYDROLYSIS</b>			
Sodium Aluminate . . . . .	31	<b>LIQUID FEED</b>	
		Accuracy . . . . .	63, 64
<b>IMPURITIES (Water)</b>		Costs . . . . .	84
Carbon Dioxide . . . . .	17	Displacement . . . . .	64
Dissolved Gases . . . . .	17	Equipment . . . . .	64, 84
Mineral Salts . . . . .	17	Installation . . . . .	84
Natural Water . . . . .	17	'Nalco' Chemical Proportioners . . . . .	64
Organic Matter . . . . .	17	Adjustments . . . . .	65
Oxygen . . . . .	17	Capacity . . . . .	65, 66
		Construction . . . . .	65
<b>INCRUSTATION</b> . . . . .	35, 39, 41, 43, 62	Costs . . . . .	84
		Drives . . . . .	65, 66
<b>INHIBITORS</b> . . . . .	41, 62, 63	Efficiencies . . . . .	65
		General Description . . . . .	65
<b>INJECTORS</b> . . . . .	35, 39, 43, 51, 62	Types . . . . .	65
		Type ADM . . . . .	75
<b>IRON</b>		Type AGB . . . . .	78, 79
Salts . . . . .	19	Type AM . . . . .	69, 70, 71, 72, 73, 74
		Type AR . . . . .	76, 77
<b>LABOUR</b> . . . . .	37, 39, 57, 60, 61, 84, 91	Type AS . . . . .	66, 67, 68, 83
		Type AW . . . . .	77
<b>'LIMBUX' (see HYDRATED LIME)</b>		Proportioning Pumps . . . . .	64
<b>LIME (see QUICKLIME and HYDRATED LIME)</b>		Pump Drives . . . . .	65, 66, 69, 75, 76, 77, 78
<b>LIME-SODA PROCESS</b> . . . . .	27, 47, 51, 55	Ram Pumps . . . . .	64, 65
'Alfloc' No. 58 Formula . . . . .	27	Water Motors (see)	
Calcium Chloride . . . . .	27		
Calcium Salts Removal . . . . .	23, 33	<b>LIQUORS (see also 'ALFLOC')</b>	
Carbon Dioxide Removal . . . . .	21, 31	'Alfloc' No. 3R . . . . .	61
Caustic Soda . . . . .	27	'Alfloc' No. 4R . . . . .	60
Chemicals, Mixing . . . . .	27	Aluminate Content . . . . .	60, 61
		Feeding (see LIQUID FEED) . . . . .	39, 60
		Handling . . . . .	84
		Stabilized . . . . .	60, 61
		Storage . . . . .	84
		'Wayside' Treatment . . . . .	39, 60, 61
		<b>LITERATURE</b> . . . . .	58

	Page		Page
<b>MAGNESIUM</b>		<b>PHOSPHATES</b>	21
Bicarbonate . . . . .	19, 21, 23	'Alfloc' No. 58 Formula . . . . .	21, 43, 45, 63
Carbonate . . . . .	21, 23	'Alfloc' No. 28 Powder . . . . .	62
Chloride . . . . .	19, 25	Calcium compounds . . . . .	62
Hydroxide . . . . .	21, 23, 25, 31, 33, 39	'Calgon' . . . . .	62
Nitrate . . . . .	19, 25	Corrosion . . . . .	43, 45
Sodium Aluminate . . . . .	23, 35	P <sub>2</sub> O <sub>5</sub> . . . . .	62, 63
Sulphate . . . . .	19, 25, 27, 47		
<b>MAGNESIUM SALTS</b> 19, 23, 25, 31, 33, 37, 47		<b>PHOSPHORUS PENTOXIDE</b> . . . . .	62
Caustic Soda . . . . .	25	<b>PIPE LINES</b> . . . . .	35, 39, 62, 63, 84
Corrosion . . . . .	35, 37	<b>PITTING</b> (see also CORROSION) . . . . .	13, 43
Lime-Soda Process . . . . .	25, 35, 47	Carbon Dioxide . . . . .	17
Sodium Carbonate . . . . .	25	Mineral Salts . . . . .	19
'Wayside' Treatment . . . . .	25, 37, 39, 47		
<b>MAINTENANCE</b> (Boiler) . . . . .	11, 13	<b>PLANT</b>	
Costs . . . . .	15	Apportioning Gear (see also) 27, 43, 63, 64	
<b>MINERAL SALTS</b> . . . . .	17, 19	Blowdown Valves . . . . .	47, 49, 53
<b>'MUFFLERS'</b> . . . . .	49	Coagulants, Use of . . . . .	29, 35
<b>'NALCO' CHEMICAL PROPORTIONER</b> (see LIQUID FEED)		Control . . . . .	27, 37, 41, 57, 63
<b>'NALCO' WATER MOTORS</b> (see WATER MOTORS)		Costs . . . . .	37, 84
<b>NEUTRALIZATION</b>		Design . . . . .	27, 29, 33, 64
Acid Waters . . . . .	21	Installation . . . . .	27
'Wayside' Treatment . . . . .	21	Labour . . . . .	37, 61, 84
<b>ORGANIC MATTER</b> . . . . .	17, 33	Lime-Soda . . . . .	27, 35
Acid Waters . . . . .	21	Liquid Feed (see)	
Aluminium Sulphate . . . . .	21	Maintenance . . . . .	55
Coagulation . . . . .	21	Mechanical Stirring . . . . .	27
Filtration . . . . .	21	Obsolescence . . . . .	55
Priming . . . . .	17	Operation . . . . .	11, 57, 63
Removal . . . . .	17, 33	Situation . . . . .	37
Sodium Aluminate . . . . .	21, 33	Sludge Removal . . . . .	29, 35, 39
Soft Waters . . . . .	21	Solid Feed (see BY-PASS FEEDERS)	
<b>OPERATING PERIODS</b> . . . . .	15, 47, 53	Starting up . . . . .	11
<b>OXYGEN</b> . . . . .	17	Storage Tanks . . . . .	27, 37, 39, 84
Removal . . . . .	21, 45, 62	Supervision . . . . .	57
Tannins . . . . .	21, 45, 62	Throughput . . . . .	33, 35, 37
<b>'PARTIAL PRECIPITATION'</b> (see 'WAYSIDE' TREATMENT)		Water Motors (see)	
<b>PERMANENT HARDNESS</b> . . . . .	19, 55, 57	'Wayside' Treatment (see also) 37, 39, 51, 63, 64	
Briquettes, 'Alfloc' . . . . .	62	<b>PRECIPITATION</b>	
Calcium Salts . . . . .	23, 37	Flocculation . . . . .	27, 33
Hard Scale . . . . .	19, 47	Lime-Soda Process . . . . .	25, 27, 29
Liquors, 'Alfloc' . . . . .	61	Silica . . . . .	25
Magnesium Salts . . . . .	23, 25, 37, 47	'Wayside' Treatment . . . . .	25, 37, 39, 41
Removal . . . . .	23, 25, 37, 41, 47, 57, 61, 62	<b>PRIMING</b> . . . . .	17, 25, 43, 45, 47, 51, 54, 63
Sodium Carbonate . . . . .	23	Blowdown . . . . .	47, 51, 53
'Wayside' Treatment 25, 37, 41, 47, 57, 61, 62		Castor Oil . . . . .	51, 63
		Causes . . . . .	45, 47, 63
		Concentration . . . . .	47
		Deconcentration . . . . .	47
		Organic Matter . . . . .	17
		Saline Waters . . . . .	19, 51, 63
		Soluble Salts . . . . .	45, 47, 51, 53, 63
		Tannins . . . . .	51, 63
		'Washouts' . . . . .	47, 51, 53
		<b>PROPORTIONING APPARATUS</b> (see also 'APPORTIONING GEAR') . . . . .	60, 63, 64
		Liquid Feed (see)	
		Solid Feed (see BY-PASS FEEDERS)	

	Page		Page
P <sub>2</sub> O <sub>5</sub> . . . . .	62, 63	<b>SOAP</b>	
<b>QUICKLIME</b>		Effect of Hard and Soft Waters on . . . . .	19
Grades . . . . .	59	Test . . . . .	53
Packing . . . . .	59	<b>SODA ASH</b> (see SODIUM CARBONATE)	
Purity . . . . .	59	<b>SODIUM ALUMINATE</b>	
Silica Content . . . . .	25	Alumina Content . . . . .	60
<b>RECOMMENDATIONS</b> . . . . .	51	Aluminium Hydroxide . . . . .	31
<b>REPAIRS</b> . . . . .	13	Aluminium Sulphate . . . . .	21
<b>RESEARCH</b>		Briquettes, 'Alfloc' . . . . .	39, 61, 62
Facilities . . . . .	11	Coagulation . . . . .	23, 31, 33, 35
<b>'RINGING'</b> (see 'CORROSION')		Colour Removal . . . . .	35
<b>SALINE WATERS</b> . . . . .	19, 51, 63	Composition . . . . .	60
Composition . . . . .	51	Corrosion . . . . .	35
Priming of . . . . .	19, 51, 63	Description . . . . .	60
Treatment . . . . .	51	Filtration . . . . .	35
<b>SAMPLING</b> . . . . .	55	Flocculation . . . . .	31, 33, 35
<b>SAVINGS</b>		Handling . . . . .	60, 84
Calculation of . . . . .	55	Hydrolysis . . . . .	31
<b>SCALE</b> . . . . .	13	Lime-Soda Process . . . . .	23, 25, 27, 31, 33, 35
Boiler Life . . . . .	13	Liquors, 'Alfloc' . . . . .	39, 60, 61, 84
Damage . . . . .	13, 15	Organic Matter Removal . . . . .	21, 33
Formation . . . . .	13, 33, 39, 41, 47	Packing . . . . .	60
Fuel Consumption . . . . .	13, 49	Plant Throughput . . . . .	33, 35
Hard . . . . .	19, 25	Silica Removal . . . . .	25, 35
Heat Transfer . . . . .	13, 49	Soda Content . . . . .	60
Mineral Salts . . . . .	19, 39, 55	Solutions . . . . .	60, 84
Prevention . . . . .	13, 33, 37, 39, 41, 47, 51, 62, 63	Special Mixtures . . . . .	63
Removal . . . . .	45	Stability . . . . .	60
Silica . . . . .	25	'Wayside' Treatment . . . . .	39, 60, 61, 62, 63
Soft . . . . .	19	<b>SODIUM BICARBONATE</b>	
<b>SEDIMENTATION</b>		Decomposition of . . . . .	19
Lime-Soda Process . . . . .	29	Saline Waters . . . . .	51
Organic Matter . . . . .	21	<b>SODIUM CARBONATE</b> . . . . .	19, 57
<b>SEPARATORS, Centrifugal</b> . . . . .	49	Calcium Salts . . . . .	23
<b>SILICA</b> . . . . .	19, 55	Decomposition . . . . .	25
Cementing Action of . . . . .	25	Grades . . . . .	59
Hard Scale . . . . .	19, 25	Lime-Soda Process . . . . .	23, 27, 33
Hydrated Lime . . . . .	25, 59	Magnesium Salts . . . . .	25
Quicklime . . . . .	25, 59	Packing . . . . .	59
Removal . . . . .	25, 35, 62	Permanent Hardness Removal . . . . .	23, 25
Sludge . . . . .	25	Purity . . . . .	59
Sodium Aluminate . . . . .	25, 35	Solubility . . . . .	59
Solubility . . . . .	25	Temporary Hardness Removal . . . . .	23
'Wayside' Treatment . . . . .	25, 62, 63	'Wayside' Treatment . . . . .	39
<b>SLEEPERS</b>		<b>SODIUM HEXAMETAPHOSPHATE</b> (see 'CALGON')	
Blowdown, Effect on . . . . .	49	<b>SODIUM</b>	
<b>SLUDGE</b> 19, 23, 25, 29, 35, 37, 39, 47, 62, 63		Aluminate (see)	
		Bicarbonate . . . . .	19, 51
		Carbonate . . . . .	19, 23, 25, 33, 39, 59
		Chloride . . . . .	19, 43, 51
		Nitrate . . . . .	19
		Salts . . . . .	19, 25, 37, 47, 51
		Sulphate . . . . .	19, 43, 51
		<b>SOFT WATER</b>	
		Organic Matter Removal . . . . .	21
		Silica Content . . . . .	25, 63
		Treatment . . . . .	55, 61, 63



	Page
SOLIDS, Feeding of (see BY-PASS FEEDERS)	
SOLUBLE SALTS	19, 25, 33, 39, 43, 47, 51, 53, 55
STABILIZATION	
'Alfloc' No. 58 Formula	43
Aluminate Liquors	60
'Wayside' Treatment	39
STORAGE TANKS	27, 37, 39, 41, 53, 60
Chemical	60, 84
" Design	84
" Materials	84
SUPERVISION	
Treatment	57
SUSPENDED MATTER	17
Calcium Carbonate	33
Organic	17, 33
Priming	47
Removal	17, 29, 33, 35, 47
Sedimentation	17, 29
TANNINS	21, 43, 45
'Alfloc' No. 58 Formula	21, 43, 45, 63
'Alfloc' No. 28 Powder	62, 63
'Alfloc' Liquors	60, 61
Antifoam	51, 63
'Calgon'	62
Corrosion	43, 45, 63
Oxygen Removal	21, 45, 62
Priming	51, 63
TECHNICAL SERVICE	11, 55, 57
TEMPORARY HARDNESS	19, 55
Composition	21
Heat, Effect of	21, 37
Hydrated Lime	23
Lime-Soda Process	23, 57
Removal	21, 37, 39, 41, 57
Sludge	19, 39
Sodium Carbonate	23
Soft Scale	19
'Wayside' Treatment	23, 37, 39, 41, 57
TESTS	57
'TOP FEED' SYSTEM	
Gas Removal by	21, 45
TRACK	
Blowdown Effect	49
TREATMENT	11, 13, 15, 17, 21, 23, 43, 51, 53
Advice on	13, 39, 41, 51
Anti-Corrosion	43, 45, 51, 53

TREATMENT—continued.	Page
Chemical Aspects	11, 21, 23
Consultation	11, 39
Control of	11, 39, 57, 63
Cost of	55, 57, 60, 61
Economic Aspects	11
Effects	13
Incorrect	25, 45, 47, 63
Need for	13
Priming	45, 47, 51
Programme	15, 53
Recommendations	51, 53, 57
Saline Waters	51, 53
Schemes	11, 53
Scientific	17
Selection of Methods	53, 55, 57
'Wayside' (see)	
TUBES	13
Corrosion	13
'Grooving'	13
Leaking	13
'Necking'	13
Pitting	13
'USER'	53, 55
Definition of	53
WASHOUTS	13, 43, 45, 47, 49, 51, 53
WATER	
Acid	21
Alkalinity	21, 33, 35, 39, 43, 45, 51, 53, 55, 63
Analysis	55, 57
Calcium Salts	19, 21, 23, 37, 55
Composition	13, 17, 47, 51, 53, 55
Corrosive (see also CORROSION)	43, 45, 53
De-Aeration	21, 45
Deconcentration	49
Dissolved Solids	47, 51, 53, 55, 63
Feed	17, 45
Hardness	15, 19, 21, 23, 33, 37, 39, 41, 51, 55, 57, 60, 61, 62
Impurities	17, 19, 23, 25, 27, 33, 39, 41
Magnesium Salts	19, 21, 23, 25, 35, 37, 55
Mineral Salts	19, 33, 47
Moorland	17, 21, 55
Motors (see)	
Natural	17
'Pick-up'	17, 53, 55
Priming of Boiler	47, 51, 63
Sampling	55, 57
Selection	13, 25, 27, 53
Silica	19, 25, 35, 55, 62, 63
Sodium Salts	19, 25, 37, 47, 51
Soft	19, 21, 41, 55, 63
Stabilization	39, 43
Storage Tanks	27, 39, 53
Suitability	13, 25, 27, 35
Supply	13, 25, 27, 35, 39, 53
Treatment	13, 21, 23, 25, 27, 31, 37, 39, 41, 45, 47, 51, 53, 55, 57, 59, 60, 61, 62, 63, 64
'Unstable'	23, 43

	Page
WATER MOTOR	65, 66, 84
'Nalco'	65, 66, 80, 81, 84
" Capacity	82
" Costs	84
" Design	80
" Operation	80, 84
" Performance	82
" Sizes	82
'WAYSIDE' TREATMENT	17, 21, 23, 25, 27, 37, 47, 55
'Alfloc' Briquettes	39, 41, 61, 62, 63, 84
'Alfloc' Liquors (see also)	39, 60, 61
'Alfloc' No. 58 Formula	39
Alkalis	21, 37, 39, 41, 63
'Blowdown'	37, 51
Calcium Salts	23, 37, 63
Carbon Dioxide Removal	21
Caustic Soda	23, 25, 39
Choice of Method	41
Control	57, 63
Corrosion	37, 39, 41, 51, 62, 63
Cost	39, 41, 57, 60, 61, 84, 91
'Deferred Reaction'	37, 41, 62, 63, 84, 90
Excess Alkalinity	51, 63
Heat, Effect of	37, 39
Incrustation	39
Inhibitors	41, 62, 63
Liquid Feed (see)	

'WAYSIDE' TREATMENT—continued.	Page
Magnesium Salts	25, 37, 39
Neutralization of Acid Waters	21
Organic Matter	21
'Partial Precipitation'	37, 39, 41, 62, 84, 89
Permanent Hardness	23, 25, 37, 57, 61, 62
Plant (see also PLANT)	39, 63, 64
Precipitation	37, 39, 41
Principles of	37, 39, 41, 61, 62, 63
Reagents	37, 39, 41, 60, 61, 62, 63
Scale Formation	39, 51, 62, 63
Settling	37
Silica	62, 63
Silica Removal	23
Sludge	23, 25, 37, 39, 63
Sodium Aluminate	39, 60, 61, 63
Sodium Carbonate	23, 39
Soft Waters	41, 55, 63
Solid Feed (see BY-PASS FEEDERS)	
Soluble Salts	47, 51, 63
Special Mixtures	63
Stabilization	39
Storage Tanks (see also)	37, 39, 41, 84
Supervision	57
Temporary Hardness	23, 37, 39, 41, 57
Types of Water	37, 39, 41, 57, 61
WELL WATER	
Sodium Bicarbonate	19

# ENQUIRIES

*for further information and supplies of Chemicals  
should be addressed to*

## *Great Britain*

ALFLOC LTD., Bush House, Aldwych, London, W.C.2  
Telephone No.: Temple Bar 6195 Inland Telegrams: 'Alfloc', Bush, London.  
Cables: 'Alfloc' London.

## *Africa*

EGYPT: Imperial Chemical Industries (Egypt), S.A. 19 Kasr-el-Nil Street, (P.O. Box 2089), Cairo.  
Branch Office at Alexandria.  
KENYA COLONY: Smith Mackenzie & Co. Ltd., Mombasa and Nairobi.  
TANGANYIKA TERRITORY: Smith Mackenzie & Co. Ltd., Dar-es-Salaam, Tanga and Lindi.  
UNION OF S. AFRICA, NORTHERN RHODESIA, SOUTHERN RHODESIA,  
PORTUGUESE E. AFRICA, PROTECTORATE OF BECHUANALAND:  
Blane & Co. Ltd., 22/32 Central House, Simmonds Street, Johannesburg.

## *Asia*

INDIA, CEYLON and BURMA: Imperial Chemical Industries (India) Ltd., 18 Strand Road,  
(P.O. Box 334), Calcutta.  
MALAYA: Imperial Chemical Industries (Malaya) Ltd., 35 Robinson Road, (P.O. Box 284),  
Singapore; And at Penang and Kuala Lumpur.  
NETHERLANDS: Internationale Crediet-en Handelsvereniging, 'Rotterdam' Samarang, Java.  
CHINA (including HONG KONG and MANCHURIA): Imperial Chemical Industries (China)  
Ltd., Head Office: 133 Szechuen Road, (P.O. Box 252), Shanghai. Present address: 12 Pedder  
Street, Hong Kong.  
JAPAN, FORMOSA and KOREA: Brunner Mond & Co. (Japan) Ltd., 72 Kyo-Machi,  
(P.O. Box 86), Kobe.  
PALESTINE, IRAQ, SYRIA and TURKEY: Imperial Chemical Industries (Levant) Ltd.,  
Imperial Chemical Industries House, Nazareth Road, (P.O. Box 412), Haifa.

## *Australasia*

AUSTRALIA and NEW ZEALAND: Brunner Mond & Co. (A'sia) Pty. Ltd., Bank of N.  
Queensland Chambers, 251 George Street, Sydney, N.S.W. *Sub-Agents:* Filtration and Water  
Softening (Pty.) Ltd. 395 Collins Street, Melbourne.

## *America, North*

CANADA: National Aluminate Chemicals, Ltd., 372 Bay Street, Toronto, Ontario.  
UNITED STATES OF AMERICA: National Aluminate Corporation, 6216, W. 66th Place,  
Chicago, Illinois.

## *America, Central*

WEST INDIES, Etc. (for information only): Imperial Chemical Industries Ltd., Royal Mail  
Building, (P.O. Box No. 2), Kingston, Jamaica.

## *America, South*

ARGENTINE and PARAGUAY: Industrias Quimicas Argentinas 'Duperial', S.A. Com.e.Ind.,  
Edificio Volta, Avenue Pres. R. Saenz, Pena 832, Buenos Aires.  
URUGUAY: Industrias Quimicas Uruguayas 'Duperial', Av. General Rondeau 2050, Montevideo.  
BRAZIL: Industrias Quimicas Brasileiras, 'Duperial', S.A. Caixa Postal 710, Rio de Janeiro.  
CHILE and BOLIVIA: Cia Imperial de Industrias Quimicas de Chile, S.A. Com.e.Ind.,  
Casilla 1357, Santiago.  
PERU and ECUADOR: Imperial Chemical Industries S.A. Peruana Com.e.Ind., Casilla 1688,  
Lima.  
BRITISH GUIANA: *Main Agents:* Geo. F. Huggins & Co. Ltd., Port of Spain, Trinidad, B.W.I.  
*Sub-Agents:* T. Geddes Grant Ltd., 46 Water Street, Georgetown.  
VENEZUELA: Parrish Ellis & Cia. Successors, Apartado 748, Caracas.  
COLOMBIA: Tracey Bros., Ltd., Apartado 1196, Bogota.

## *Europe*

HOLLAND: N. V. Kerlen & Co., de Mildestraat 36, 's Gravenhage.  
BELGIUM: Monsieur R. Dumont, 56 Avenue Brugmann, Bruxelles.

*In other territories other than the foregoing, enquiries should be  
addressed to*

**ALFLOC LTD.**

**BUSH HOUSE, ALDWYCH, LONDON, W.C.2**

Telephone No.: Temple Bar 6195. Inland Telegrams: 'Alfloc', Bush, London.  
Cables: 'Alfloc', London.

*'Alfloc' is the Registered Trade Mark of Alfloc Ltd.*

*'Limbux' is the Registered Trade Mark of I.C.I.  
(Lime) Ltd., an associated company of Imperial  
Chemical Industries Ltd.*

*'Calgon' is a Trade Mark of Keith Piercy Limited.*

THE HOUSE OF COMMONS

IN PARLIAMENT ASSEMBLED

THE 15th DAY OF APRIL 1854

REPORT

OF THE

COMMISSIONERS OF THE

LAND TAX

FOR THE YEAR 1854

AND

FOR THE YEAR 1855

BY

ALFRED R. WALLACE

OF THE OFFICE OF THE

COMMISSIONERS

OF THE LAND TAX

AND

OF THE

LAND TAX

FOR THE YEAR 1854

AND

FOR THE YEAR 1855

PRINTED BY

